

# Hydraulic seals

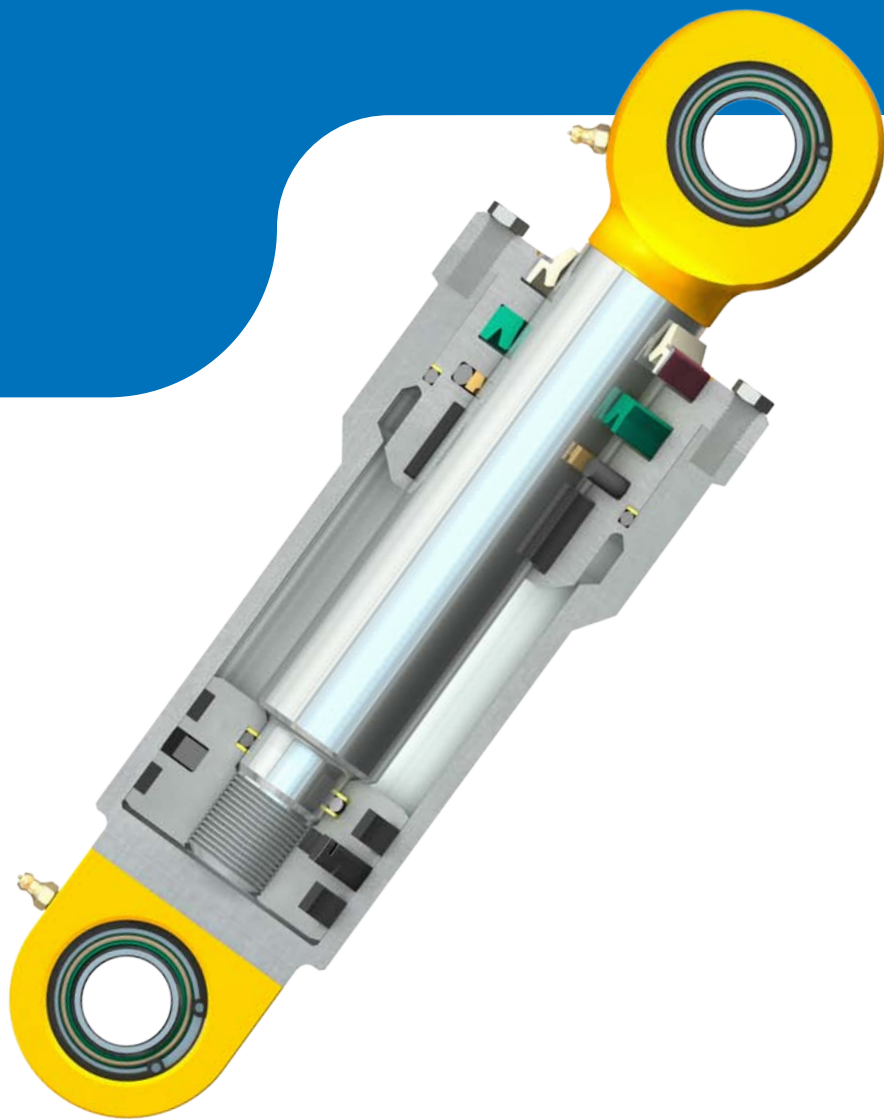

## SKF mobile apps

SKF mobile apps are available from both Apple App Store and Google Play. These apps provide useful information and allow you to make critical calculations, providing SKF Knowledge Engineering at your fingertips.

## Register your catalogue

You can get updates for this catalogue via email if you register at [skf.com/catalogues](http://skf.com/catalogues).



*Apple App Store*

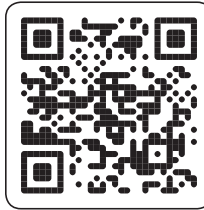

*Google Play*

© SKF, ECOPUR, FLUOROTREL, LUBRITHANE, SEAL JET, SPECTRASEAL, TEFLATHANE and X-SLIDE are registered trademarks of the SKF Group.

™ X-ECOPUR is a trademark of the SKF Group.

Apple is a trademark of Apple Inc., registered in the US and other countries.

Google Play is a trademark of Google Inc.

© SKF Group 2012

The contents of this publication are the copyright of the publisher and may not be reproduced (even extracts) unless prior written permission is granted. Every care has been taken to ensure the accuracy of the information contained in this publication but no liability can be accepted for any loss or damage whether direct, indirect or consequential arising out of the use of the information contained herein.

**PUB SE/P1 12393/1 EN** · April 2013

This publication supersedes publication 5397.

Certain image(s) used under license from Shutterstock.com

SKF hydraulic seals – general technical information . . .	21	1
Piston seals . . . . .	45	2
Rod and buffer seals . . . . .	111	3
Wiper seals . . . . .	207	4
Guide rings and guide strips . . . . .	249	5
O-rings and back-up rings . . . . .	291	6
Other fluid power applications . . . . .	347	7
Product index . . . . .	352	8

# Content

<b>Unit conversions</b> .....	<b>4</b>
<b>Foreword</b> .....	<b>5</b>
<b>This is SKF</b> .....	<b>8</b>
<b>SKF – the knowledge engineering company</b> .....	<b>10</b>
<b>Introduction to fluid power</b> .....	<b>12</b>
Hydraulic cylinders .....	13
Cylinder classification .....	14
Hydraulic seals and guides .....	14
SKF hydraulic seals and guides capabilities .....	16
Customized sealing solutions .....	16
SKF SEAL JET system .....	17
Criteria for seal selection .....	18
<b>1 SKF hydraulic seals – general technical information</b> .....	<b>21</b>
Specifications for effective sealing systems .....	22
Gap extrusion .....	34
Storage .....	36
Installation and assembly .....	38
<b>2 Piston seals</b> .....	<b>45</b>
Product tables .....	
2.1 MPV, metric sizes .....	59
2.2 DPV, inch sizes .....	61
2.3 LPV, metric sizes .....	63
2.4 CPV, inch sizes .....	65
2.5 GH, metric sizes .....	67
GH, inch sizes .....	70
2.6 APR, metric sizes .....	77
APR, inch sizes .....	79
2.7 LCP, metric sizes .....	83
LCP, inch sizes .....	85
2.8 LTP, inch sizes .....	87
2.9 CUT, metric sizes .....	91
2.10 SCP, inch sizes .....	95
2.11 MD-L, metric sizes .....	99
2.12 UNP, metric sizes .....	103
UNP, inch sizes .....	105
More piston seals .....	108

<b>3 Rod and buffer seals</b> .....	<b>111</b>
Product tables	
3.1 S1S, metric sizes .....	123
3.2 ZBR, metric sizes .....	127
ZBR, inch sizes .....	131
3.3 SIL, metric sizes .....	135
3.4 PTB, metric sizes .....	139
PTB, inch sizes .....	149
3.5 STD, inch sizes .....	165
3.6 DZ, metric sizes .....	179
DZ, inch sizes .....	180
3.7 DZR, metric sizes .....	185
DZR, inch sizes .....	186
3.8 RBB, metric sizes .....	189
RBB, inch sizes .....	191
3.9 S9B, metric sizes .....	193
S9B, inch sizes .....	196
3.10 RSB, inch sizes .....	199
More rod and buffer seals .....	202
<b>4 Wiper seals</b> .....	<b>207</b>
Product tables	
4.1 PA, metric sizes .....	217
4.2 MCW, metric sizes .....	221
MCW, inch sizes .....	223
4.3 PAD and PADV, metric sizes .....	227
4.4 DTW, metric sizes .....	229
DTW, inch sizes .....	232
4.5 DX, inch sizes .....	237
4.6 HW, metric sizes .....	241
HW, inch sizes .....	243
More wiper seals .....	246
<b>5 Guide rings and guide strips</b> .....	<b>249</b>
Product tables	
5.1 WAT rod or piston guide rings, metric sizes .....	260
5.2 WAT rod or piston guide rings, inch sizes .....	266
5.3 RGR rod guide rings, metric sizes .....	280
5.4 PGR piston guide rings, metric sizes .....	284
More guide rings .....	288
<b>6 O-rings and back-up rings</b> .....	<b>291</b>
Product tables	
6.1 OR O-rings in static radial sealing, metric sizes .....	300
6.2 OR O-rings in static radial sealing, inch sizes .....	316
6.3 STR Back-up rings in static radial sealing, metric sizes by dash number .....	324
6.4 STR Back-up rings in static radial sealing, metric sizes .....	334
6.5 STR Back-up rings in static radial sealing, inch sizes .....	338
Other O-ring sealing and ring materials .....	344
<b>7 Other fluid power applications</b> .....	<b>347</b>
<b>8 Product index</b> .....	<b>352</b>

# Unit conversions

## Unit conversions

Quantity	Unit	Conversion			
<b>Length</b>	inch	1 mm	0.03937 in.	1 in.	25,40 mm
	foot	1 m	3.281 ft.	1 ft.	0,3048 m
	yard	1 m	1.094 yd.	1 yd.	0,9144 m
	mile	1 km	0.6214 mi.	1 mi.	1,609 km
<b>Speed, velocity</b>	foot per second	1 m/s	3.28 ft/s	1 ft/s	0,30480 m/s
	foot per minute	1 m/s	196.8504 ft/min	1 ft/min	0,00508 m/s
	mile per hour	1 km/h	0.6214 mph	1 mph	1,609 km/h
<b>Force</b>	pound-force	1 N	0.225 lbf.	1 lbf.	4,4482 N
<b>Pressure, stress</b>	pounds per square inch	1 MPa	145 psi	1 psi	$6,8948 \times 10^3$ Pa
		1 N/mm <sup>2</sup>	145 psi		
		1 bar	14.5 psi	1 psi	0,068948 bar
<b>Temperature</b>	degree	Celsius	$t_c = 0.555 (t_f - 32)$	Fahrenheit	$t_f = 1.8 t_c + 32$

# Foreword

This catalogue contains the standard assortment of SKF hydraulic seals and guides typically used in hydraulic cylinders. To provide the highest levels of quality and customer service, these products are available worldwide through SKF sales channels. For information about lead times and deliveries, contact your local SKF representative or SKF Authorized Distributor.

This catalogue reflects SKF's state-of-the-art technology and production capabilities as of 2012. The data contained within may differ from that shown in earlier catalogues because of redesign, technological developments, or revised calculation methods. SKF reserves the right to continually improve its products with respect to materials, design and manufacturing methods, some of which are driven by technological developments.

## Getting started

*Introduction to fluid power* provides an overview over hydraulic cylinder types and classification with reference to SKF customized solutions and standard assortment of hydraulic seals and guides. The first chapter contains general technical information. Seal counter-surface finish properties, materials, fluid media and gap extrusion are discussed in detail. Furthermore product storage and installation information is included.

## Guidance values

Since several factors simultaneously affect the sealing system and seal performance, all stated values in graphs and tables in this publication should be considered as guidelines only and not as absolute values for practical applications.

## How best to use this catalogue

The catalogue follows an easy principle:

- *Introduction to fluid power* (→ **pages 12 to 18**) provides basic information about hydraulic seals.
- Chapter 1 (→ **pages 21 to 43**) provides general technical information, such as counter-surface finish properties, materials, fluid media.
- Chapters 2 to 6 provide product type specific information. A profile overview at the beginning shows the different profiles with a brief description and reference to more information inside the chapter. Product type and profile characteristics are discussed in detail. The profile data tables provide product specifications per profile followed by the relevant product tables with dimensions per item. At the end of the chapter more profiles of the specific type are outlined, including examples of the machined seal profiles manufactured with the SKF SEAL JET technology.
- Chapter 7 (→ **pages 347 to 351**) provides some information on other types of fluid power seals used both in hydraulic cylinder and other applications.
- Chapter 8 contains the product index (→ **page 352**) sorted by the profiles.

### Find product details quickly

Blue tabs on each right hand page show the chapter or product table number.

A quick way to access detailed product data is via the product table numbers. They are listed in the full table of contents at the front of the catalogue, in the table of contents of each product chapter and in the product index.

Profile	Description	Additional information → page
MPV	Polyurethane slide ring, nitrile rubber energizer; suitable for heavy duty applications	50
DVP	Polyurethane slide ring, nitrile rubber energizer; fits wide, shallow groove housings; suitable for heavy duty applications	51
LPV	Polyether-based polyurethane slide ring, nitrile rubber energizer; suitable for light to medium duty applications	51
CPV	Polyurethane slide ring, nitrile rubber energizer; suitable for light to medium duty applications	51

Profile overview

Tolerance	d	Tolerance	L	S	R	C	Designation
			10-002		max.	min.	
+0.000	0.889	+0.001	0.128	0.149	0.015	0.125	SKFA-1187-AD1
+0.002	0.927	+0.003	0.163	0.175	0.015	0.175	GMD-1187-AD2
+0.002	1.016	+0.003	0.163	0.167	0.025	0.175	GMD-1187-AD2
+0.002	1.076	+0.003	0.128	0.149	0.015	0.125	GMD-1187-AD2
+0.002	1.115	+0.003	0.128	0.149	0.015	0.125	GMD-1187-AD2
+0.002	1.152	+0.003	0.163	0.167	0.025	0.175	GMD-1187-AD2
+0.002	1.213	+0.003	0.128	0.149	0.015	0.125	GMD-1187-AD2
+0.002	1.250	+0.003	0.163	0.167	0.025	0.175	GMD-1187-AD2
+0.002	1.311	+0.003	0.128	0.149	0.015	0.125	GMD-1187-AD2
+0.002	1.349	+0.003	0.163	0.167	0.025	0.175	GMD-1187-AD2
+0.002	1.410	+0.003	0.128	0.149	0.015	0.125	GMD-1187-AD2
+0.002	1.448	+0.003	0.163	0.167	0.025	0.175	GMD-1187-AD2
+0.002	1.509	+0.003	0.128	0.149	0.015	0.125	GMD-1187-AD2
+0.002	1.547	+0.003	0.163	0.167	0.025	0.175	GMD-1187-AD2
+0.002	1.608	+0.003	0.128	0.149	0.015	0.125	GMD-1187-AD2
+0.002	1.646	+0.003	0.163	0.167	0.025	0.175	GMD-1187-AD2

Numbered product table



### Colour coding for material

The product illustrations in this catalogue use a colour coding system to indicate the material group, but they do not match the actual material colours. For information about the actual material colours, refer to *Materials* (→ **page 26**).

### Consistent colour coding for material groups

 Thermoplastic polyurethane elastomer (TPU), moulded articles

 Thermoplastic polyurethane elastomer (TPU), machined articles

 Rubber

 Rigid thermoplastics

 Unfilled PTFE and other engineering plastics

 Filled PTFE

 Phenolic resins

 Polyester thermoplastic elastomers (TPC)

 Metal

### Units of measurement

This catalogue is for global use. Therefore, the predominant units of measurement are in accordance with ISO 80000-1. Imperial units are used whenever necessary. Unit conversions can be made using the conversion table (→ **page 4**).

For easier use, some values are provided in both metric and imperial values. Values are typically rounded. Therefore, the two values do not always match according to the conversion formula.

# This is SKF

From one simple but inspired solution to a misalignment problem in a textile mill in Sweden, and fifteen employees in 1907, SKF has grown to become a global industrial knowledge leader. Over the years we have built on our expertise in bearings, extending it to seals, mechatronics, services and lubrication systems. Our knowledge network includes 46 000 employees, 15 000 distributor partners, offices in more than 130 countries, and a growing number of SKF Solution Factory sites around the world.



## Research and development

We have hands-on experience in over forty industries, based on our employees' knowledge of real life conditions. In addition our world-leading experts and university partners who pioneer advanced theoretical research and development in areas including tribology, condition monitoring, asset management and bearing life theory. Our ongoing commitment to research and development helps us keep our customers at the forefront of their industries.



*SKF Solution Factory makes SKF knowledge and manufacturing expertise available locally, to provide unique solutions and services to our customers.*

## Meeting the toughest challenges

Our network of knowledge and experience along with our understanding of how our core technologies can be combined helps us create innovative solutions that meet the toughest of challenges. We work closely with our customers throughout the asset life cycle, helping them to profitably and responsibly grow their businesses.

## Working for a sustainable future

Since 2005, SKF has worked to reduce the negative environmental impact from our own operations and those of our suppliers. Our continuing technology development introduced the SKF BeyondZero portfolio of products and services which improve efficiency and reduce energy losses, as well as enable new technologies harnessing wind, solar and ocean power. This combined approach helps reduce the environmental impact both in our own operations and in our customers'.



*Working with SKF IT and logistics systems and application experts, SKF Authorized Distributors deliver a valuable mix of product and application knowledge to customers worldwide.*



# SKF – the knowledge engineering company

## Our knowledge – your success

*SKF Life Cycle Management is how we combine our technology platforms and advanced services, and apply them at each stage of the asset life cycle, to help our customers to be more successful, sustainable and profitable.*

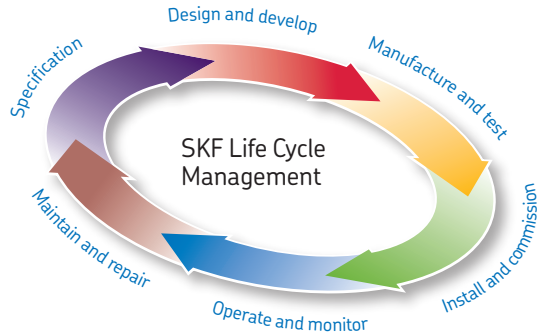

### Working closely with you

Our objective is to help our customers improve productivity, minimize maintenance, achieve higher energy and resource efficiency, and optimize designs for long service life and reliability.

### Innovative solutions

Whether the application is linear or rotary or a combination of the two, SKF engineers can work with you at each stage of the asset life cycle to improve machine performance by looking at the

entire application. This approach doesn't just focus on individual components like bearings or seals. It looks at the whole application to see how each component interacts with the next.

### Design optimization and verification

SKF can work with you to optimize current or new designs with proprietary 3-D modeling software that can also be used as a virtual test rig to confirm the integrity of the design.



### **Bearings**

*SKF is the world leader in the design, development and manufacture of high performance rolling bearings, plain bearings, bearing units and housings.*



### **Machinery maintenance**

*Condition monitoring technologies and maintenance services from SKF can help minimize unplanned downtime, improve operational efficiency and reduce maintenance costs.*



### **Sealing solutions**

*SKF offers standard seals and custom engineered sealing solutions to increase uptime, improve machine reliability, reduce friction and power losses, and extend lubricant life.*



### **Mechatronics**

*SKF fly-by-wire systems for aircraft and drive-by-wire systems for off-road, agricultural and forklift applications replace heavy, grease or oil consuming mechanical and hydraulic systems.*



### **Lubrication solutions**

*From specialized lubricants to state-of-the-art lubrication systems and lubrication management services, lubrication solutions from SKF can help to reduce lubrication related downtime and lubricant consumption.*



### **Actuation and motion control**

*With a wide assortment of products – from actuators and ball screws to profile rail guides – SKF can work with you to solve your most pressing linear system challenges.*

# Introduction to fluid power

Fluid power systems transfer and utilize mechanical power through a working fluid. Energy is transmitted, stored and used through the transfer and pressure of fluids. By utilizing differential surface areas acted upon by the pressure of the working fluid, a mechanical advantage can be achieved. There are two main types of fluid power system:

- hydraulic – using liquid, such as oil, for the working fluid
- pneumatic – using gas, such as air, for the working fluid

Fig. 1

Double-acting hydraulic cylinder

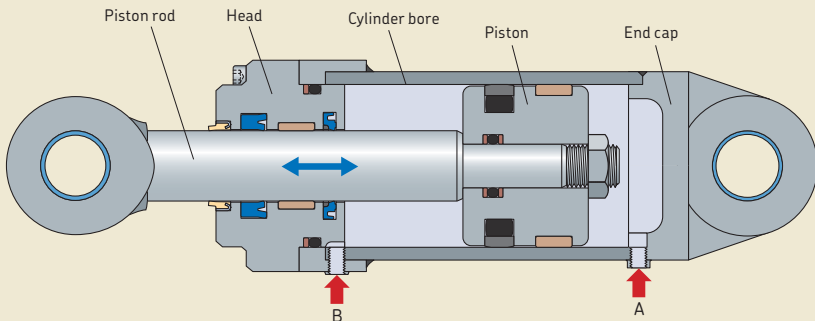

# Hydraulic cylinders

A hydraulic cylinder is a linear actuator used to push or pull a load, or to selectively resist motion under load, by means of fluid pressure. Double-acting cylinders, the most common type, are able to push and pull (→ **fig. 1**). High pressure fluid pumped into the extend chamber (port “A”) acts on the piston to push the piston rod out, thereby extending the length of the cylinder. Inversely, to retract the piston rod and reduce the length of the assembly, high pressure fluid is pumped into the retract chamber (port “B”) and acts on the opposite side of the piston.

Other cylinder types are shown in **figure 2**. A cylinder which can only push but not pull is referred to as a single-acting cylinder. High pressure fluid is pumped into the extend chamber (port “A”) and acts on the piston to push the piston rod out. An external force is required to return the cylinder to the retracted position. A typical application for a single-act-

ing cylinder is a lift truck, where the load of the fork pushes the cylinder back. Multi-stage cylinders (also referred to as telescoping cylinders) have two or more piston rods in a coaxial arrangement to achieve greater extended length compared to the retracted length.

Fig. 2

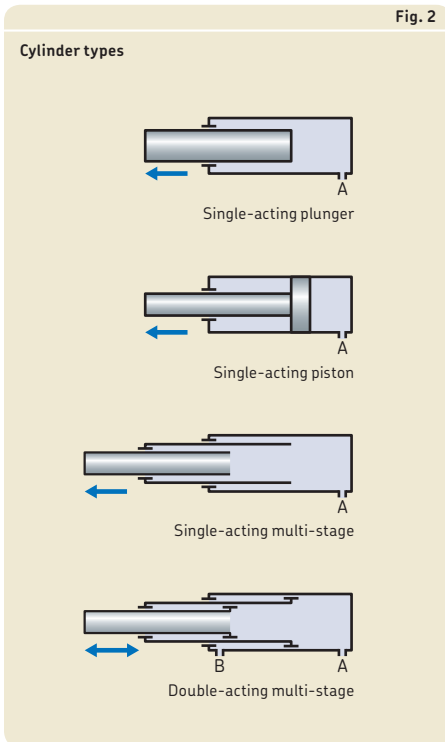

## Cylinder classification

The type of cylinder and the application in which it's used are two of the main criteria to determine which seals and guides are selected. Applications are referred to as light duty, medium duty or heavy duty applications. These classifications are somewhat subjective but the duty levels are typically characterized by the following criteria.

### Light duty cylinders

Light duty cylinders, e.g. cylinders used for stationary equipment indoor in a factory environment, may be characterized by:

- system pressures up to 160 bar (2 300 psi)
- temperature up to 70 °C (160 °F)
- rare pressure peaks in excess of system pressure
- minimal side loads acting on guides
- environment with moderate temperature fluctuations and relatively free of contaminants

### Medium duty cylinders

Medium duty cylinders, e.g. cylinders in agriculture off-highway equipment, may be characterized by:

- system pressures up to 250 bar (3 625 psi)
- temperature up to 90 °C (195 °F)
- moderate pressure peaks in excess of system pressure
- moderate side loads acting on guides
- environment with temperature fluctuations with climate and typical external contaminants such as dust and moisture

### Heavy duty cylinders

Heavy-duty cylinders, e.g. cylinders in off-highway earthmoving or forestry equipment, may be characterized by:

- system pressures of 400 bar (5 800 psi) or more
- temperatures exceeding 90 °C (195 °F) with peaks in excess of 110 °C (230 °F)
- regular pressure peaks in excess of system pressure
- heavy side loads acting on guides, usually due to heavy components and/or high accelerations

- tough environment with wide temperature fluctuations and typical harsh external contaminants

## Hydraulic seals and guides

Hydraulic cylinder seals are used to seal the opening between various components in the hydraulic cylinder. **Figure 3** shows an example of the seal and guide components of a heavy duty cylinder. There are two main types of hydraulic seals in the system:

- **Dynamic seals**  
They seal between components in relative motion. In a hydraulic cylinder the rod sealing system seals dynamic reciprocating motion between the piston rod and head, while the piston sealing system seals dynamic reciprocating motion between the piston and cylinder bore.
- **Static seals**  
They seal between components fixed together without relative motion. Hydraulic cylinders use static seals in various locations depending on the design and construction. The most common are static seals between the piston and piston rod and between the head and cylinder bore tube.

Each dynamic seal in a hydraulic cylinder has a special function to contribute to the performance of the system:

### Piston seal functions

- act as pressure barrier and prevent fluid passing the piston – important for controlling the cylinder motion or maintaining the position when at rest

### Rod seal functions

- act as pressure barrier and keep the operating fluid inside the cylinder
- regulate the fluid film which extends with the surface of the piston rod – important to inhibit rod corrosion and to lubricate the wiper seal and the rod seal itself
- accept the lubrication film back into the cylinder when the rod retracts



### Buffer seal functions

- protect the rod seal from fluid pressure peaks in excess of system pressure
- attenuate the fluctuations in system pressure, thereby improving rod seal performance by allowing the rod seal to deal with more constant or gradually changing pressure
- act as an internal excluder to keep system contaminants, such as metal particles, from damaging the rod seal

### Wiper seal functions

- exclude external contaminants from entering the cylinder assembly and the hydraulic system
- accept the lubrication film back into the cylinder when the rod retracts

### Guide rings (rod and piston) functions

- prevent metal-to-metal contact between components
- react the radial load caused by side loads on the cylinder assembly
- keep the piston rod and piston accurately centred in the cylinder assembly – important for performance of the rod sealing system and piston sealing system

The subsequent chapters contain additional information regarding the function of each seal or guide in the system and the choices for each.

Fig. 3

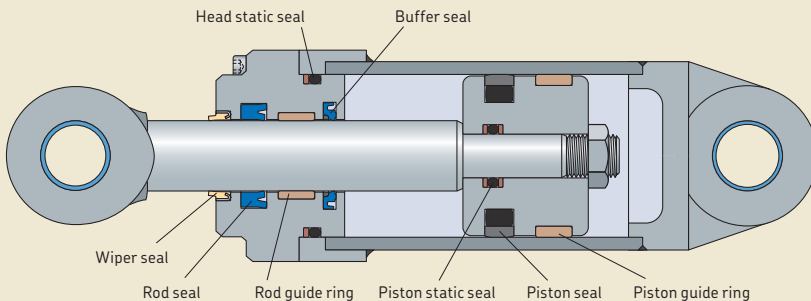

## SKF hydraulic seals and guides capabilities

The SKF assortment of hydraulic seals comprises hundreds of different designs and material combinations. The products shown in this catalogue are the more commonly used seal profiles and sizes for hydraulic cylinders. The flexible SKF manufacturing systems and processes, combined with the industry's most agile and comprehensive design and engineering capability, allow additional profiles and sizes to be added on a daily basis. If application requirements are not served by the common profiles or sizes in this catalogue, contact SKF to provide a specific offer.

### Customized sealing solutions

In addition to the standard assortment of series-produced seals and sizes listed in this catalogue, SKF designs and manufactures hydraulic seals customized for virtually any requirements.

The design and development of high performance materials combined with testing and failure analysis are vital elements for successful seal development. SKF combines these elements with its extensive application knowledge, to offer solutions that are based on an understanding of sealing systems under various real conditions. SKF continuously develops new customized materials and designs and operates its own testing facilities around the world to provide optimized sealing solutions that meet the sophisticated demands of many industries.

### Finite element analysis (FEA)

FEA is used to simulate the impact of operating conditions, material selection and seal design on seal behaviour (→ fig. 4).

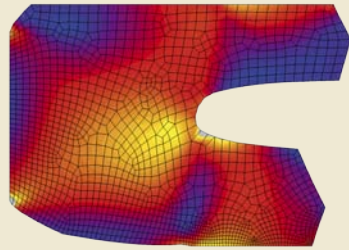

## SKF SEAL JET system

The innovative production system SKF SEAL JET reduces manufacturing and dispatch time to a minimum. Virtually any kind of seal for any conceivable application, in any dimension and design, can be produced. SKF operates more than 200 machining centres worldwide and aims to be located as close to the customer as possible. With local and global application engineering teams and research and development centres, Machined seals (→ **fig. 5**) produced with SKF SEAL JET machines (→ **fig. 6**) can be customized to meet the most stringent sealing requirements of many industries. Key factors of the SKF SEAL JET systems (→ **fig. 7**) are:

- partnership with customers from the design phase to serial production with tailor made solutions
- prompt manufacturing of seals and components up to 4 000 mm (157 in.) in diameter as one piece and larger with short delivery times
- diameters up to 10 000 mm (395 in.) and larger by using a special welding technique
- virtually unlimited seal designs
- extensive range of sealing materials including materials certified to or complying with a broad range of industry standards and regulations (FDA, NSF, KTW, NORSOK, NACE, etc.)

Fig. 5

Machined seals



Fig. 6

SKF SEAL JET machine



Fig. 7

SKF SEAL JET system



## Criteria for seal selection

The selection of the right seal profile and material for a given application requires consideration of many factors. Furthermore, a sealing system, such as a rod sealing system, includes many components. This catalogue supports selection of the right seal for typical hydraulic seal applications and existing cylinder designs. For any application factors outside of the ordinary, or to specify sealing systems in new hydraulic cylinder designs, a certain amount of expertise, beyond the content of this catalogue, may be required. The hydraulic seal experts at SKF can assist in selecting the right seal system for new cylinder designs.

Before seals can be selected certain application parameters and information should be collected. The following most common application considerations are nearly always required when selecting hydraulic seals:

- fluid pressure range,  
the range of operating fluid system pressure, as well as frequency and severity of pressure peaks
- temperature range,  
the range of the fluid and cylinder assembly, both when operating and at rest
- speed,  
the stroking speed of the reciprocating piston rod
- fluid media,  
the type and viscosity of fluid used in the system
- hardware dimensions,  
the rod and bore diameters, seal groove dimensions and gaps (if already specified), cylinder overall length and stroke length as well as surface finish specifications (if already specified)
- application of the cylinder,  
the type of equipment the cylinder will be used on and what will the cylinder do in the equipment including mounting, duty cycle and environmental factors (external temperature, contaminants)





# SKF hydraulic seals – general technical information

<b>Specifications for effective sealing systems</b> . . . . .	<b>22</b>
Counter-surface finish properties . . . . .	22
Recommendations for dynamic sealing surfaces . . . . .	24
Recommendations for static seal surfaces . . . . .	25
Materials . . . . .	26
Thermoplastic elastomers . . . . .	26
Rubbers . . . . .	27
PTFE . . . . .	27
Rigid thermoplastics and thermosets . . . . .	27
Hydraulic fluids . . . . .	31
<b>Gap extrusion</b> . . . . .	<b>34</b>
<b>Storage</b> . . . . .	<b>36</b>
Storage conditions . . . . .	36
Shelf life . . . . .	37
<b>Installation and assembly</b> . . . . .	<b>38</b>
Seal housings . . . . .	38
Corner radii . . . . .	38
Groove edge radii . . . . .	39
Installation chamfers . . . . .	40
Installing rod seals . . . . .	40
Installing piston seals . . . . .	42
Installing wiper seals . . . . .	43

## Specifications for effective sealing systems

Designing hydraulic rod and piston sealing systems requires careful attention to the dynamic seal interaction and the principles of tribology to ensure long service life, proper seal function, minimal wear, low friction and smooth operation. Tribology is the study of the design, friction, wear and lubrication of interacting surfaces in relative motion. The most important considerations for tribological properties of a dynamic sealing system are:

- the seal material
- the seal profile design
- the counter-surface material and finish properties
- the hydraulic fluid, which is the lubrication for the dynamic seal surfaces

For information about seal profile design, see the relevant product chapter.

### Counter-surface finish properties

The surface properties of the cylinder bore and the piston rod have a great influence on

the function and service life of the seal. Parameters for specifying a surface finish are defined by ISO 4287. The most common surface roughness parameter specified is  $R_a$  (in units  $\mu\text{m}$  or  $\mu\text{in}$ ), i.e. the arithmetic mean deviation of the surface profile. This value does not, however, completely describe how the surface can be expected to affect the seal. The reason for this is that two surfaces with the same values of  $R_a$  but with different surface profile characteristics can result in a varying lubrication film thickness and, therefore, causing a very different degree of seal performance and wear.

The material ratio curve (Abbott-Firestone curve) provides more information about the surface profile characteristics. It describes the ratio of the material-filled length to the evaluation length at a given cutting depth expressed in percent ( $\rightarrow$  fig. 1). The slope at the beginning of the curve represents the peaks in the profile, which are causing initial wear on the seal. The slope at the end of the curve represents the valleys in the profile, which serve as lubricant reservoirs.

Fig. 1

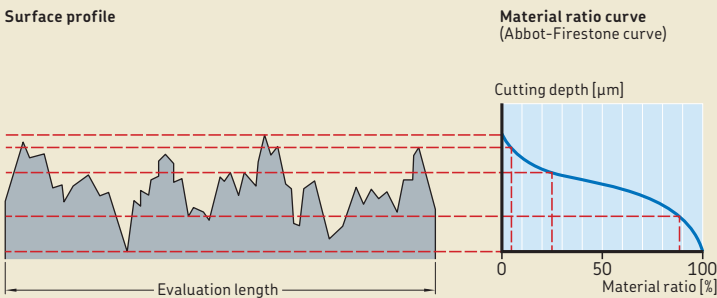
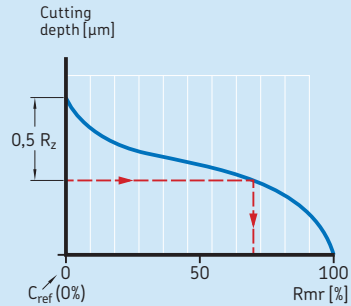



Diagram 1



1

**Table 1** shows some surface profiles. Only the finished surface can serve as a seal counter-surface. To ensure a surface with suitable profile and characteristics for effective dynamic sealing, recommendations are given in a combination of the following surface parameters:

- $R_a$  – average roughness
- $R_z$  – mean roughness depth
- $R_{max}$  – maximum surface roughness
- $Rmr$  – material ratio

SKF recommends evaluating  $Rmr$  at a cutting depth of  $0,5 R_z$  based on  $c_{ref} = 0\%$  (→ **diagram 1**).

Table 1

Seal counter-surface examples

Surface profile	$R_a$	$R_z$	$R_{max}$	$Rmr$	Material ratio curve
–	$\mu\text{m}$	$\mu\text{m}$	$\mu\text{m}$	%	–
<p><b>Eroded surface</b></p>	2,4	7,3	10,4	≈ 40	
<p><b>Machined surface</b></p>	2,5	9,5	10,2	≈ 20 ... 25	
<p><b>Finished surface</b></p>	0,09	1,2	1,8	≈ 90	

## General technical information

### Recommendations for dynamic sealing surfaces

The dynamic sealing surfaces on the piston rod and in the cylinder bore (→ **fig. 2**) require similar, but somewhat different surface finishing.

#### Piston rod

The recommendations for the piston rod sealing surface (→ **table 2**) assume that typical materials and process are used to manufacture the piston rod by induction hardening carbon steel shaft, grinding, hard-chromium plating and then polishing to achieve the specified diameter and finish.

For alternative rod materials and coatings, other surface specifications, finishing methods, seal materials and designs may be required. Examples of such alternative rod coatings include:

- various hard metals applied by high velocity oxygen fuel (HVOF)
- ceramic coatings of various compositions and finishes
- stainless steel
- iron nitride

For recommendations for sealing systems with alternative rod materials and coatings, contact SKF.

Table 2

Recommendations for the dynamic sealing surface on piston rods (induction hardened and chrome plated rods)

	Thermoplastics and rubbers	PTFE materials
$R_a$	0,05 to 0,3 $\mu\text{m}$ (2 to 12 $\mu\text{in.}$ )	0,05 to 0,2 $\mu\text{m}$ (2 to 8 $\mu\text{in.}$ )
$R_z$	0,4 to 2,5 $\mu\text{m}$ (15 to 100 $\mu\text{in.}$ )	0,4 to 2 $\mu\text{m}$ (15 to 80 $\mu\text{in.}$ )
$R_{\text{max}}$	0,4 to 2,5 $\mu\text{m}$ (15 to 100 $\mu\text{in.}$ )	
$R_{\text{mr}}$	50 to 95% (cutting depth 0,5 $R_z$ based on $c_{\text{ref}} = 0\%$ )	
Hardness	$\geq 50$ HRC	
Hardening depth	-1,2 to 2,5 mm (-0.05 to 0.1 in.)	
Chromium layer thickness	-20 to 30 $\mu\text{m}$ (-0.0008 to 0.001 in.)	

Fig. 2

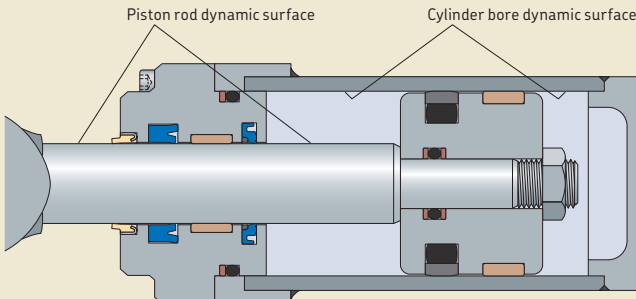

Table 3

Recommendations for the dynamic sealing surface on cylinder bores  
(honed or roller burnished tubes)

Thermoplastics, rubbers and PTFE materials

$R_a$	0,05 to 0,2 $\mu\text{m}$ (2 to 8 $\mu\text{in.}$ )
$R_z$	0,4 to 2 $\mu\text{m}$ (15 to 80 $\mu\text{in.}$ )
$R_{\text{max}}$	0,4 to 2,5 $\mu\text{m}$ (15 to 100 $\mu\text{in.}$ )
$R_{\text{mr}}$	50 to 95% (cutting depth 0,5 $R_z$ based on $c_{\text{ref}} = 0\%$ )

### Cylinder bore

The recommendations for the cylinder bore surface ( $\rightarrow$  table 3) assume that typical materials and processes are used to machine the bore by either honing or roller burnishing to achieve the specified diameter and finish.

### Recommendations for static seal surfaces

Static sealing surfaces must also have a proper surface finish to enable the desired sealing performance ( $\rightarrow$  fig. 3).

The counter-surfaces of static seals exposed to pressure, including the static side of dynamic rod and piston seals, should have a roughness  $R_a \leq 0,8 \mu\text{m}$  (30  $\mu\text{in.}$ ).

Seat diameters of guide rings and wiper seals, should have a roughness  $R_a \leq 1,6 \mu\text{m}$  (63  $\mu\text{in.}$ ). Axial faces of all grooves should have a roughness  $R_a \leq 3,2 \mu\text{m}$  (125  $\mu\text{in.}$ ).

Fig. 3

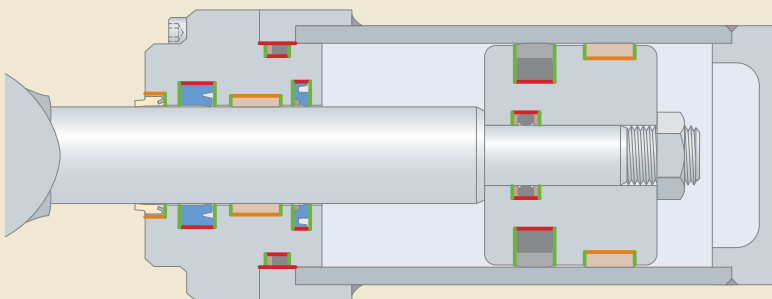

- Counter-surfaces of static seals exposed to pressure  
 $R_a \leq 0,8 \mu\text{m}$  (30  $\mu\text{in.}$ )
- Seat diameters of guide rings and wiper seals  
 $R_a \leq 1,6 \mu\text{m}$  (63  $\mu\text{in.}$ )
- Axial faces of all grooves  
 $R_a \leq 3,2 \mu\text{m}$  (125  $\mu\text{in.}$ )

## General technical information

### Materials

Materials play a major role in the performance and lifetime of seals. Generally, hydraulic seals are exposed to a variety of application and working conditions, such as a wide temperature range, contact with various hydraulic fluids and the outside environment as well as high pressure and contact forces. The appropriate seal materials have to be selected to achieve a reasonable service life and service intervals. A wide variety of seal materials from four major polymeric material groups is available:

- thermoplastic elastomers, such as polyurethane (TPU) and thermoplastic ether-ester block copolymers (TPC)
- rubbers, such as nitrile (NBR) and hydrogenated nitrile rubber (HNBR), fluorocarbon rubbers (FKM, FPM)
- polytetrafluorethylene (PTFE) and its compounds
- rigid thermoplastics and thermosets and their composites

To support sealing function and keep the contact force for long seal life, many different properties should be considered to provide effective seal materials. Examples include:

- good elasticity over a wide temperature range, especially at low temperatures
- excellent compression set and stress relaxation behaviour to keep the sealing force for the requested operating period
- reasonable hardness and flexibility to avoid leakage and allow easy installation
- superior gap extrusion resistance to cover the increased pressures of fluid power equipment
- adequate working temperature range
- good chemical compatibility to cover a wide assortment of hydraulic fluids such as mineral and synthetic oils, biodegradable and water-based fluids or fire-resistant fluids
- excellent tribological properties, i.e. low friction values and high wear resistance to achieve a high efficiency and avoid early failures especially when sealing against rough counter surfaces

In addition to these considerations, the structure and morphology of polymeric materials

make selection and specification of seal materials much more complicated than the standard materials used in mechanical engineering (e.g. aluminium or steel). Mechanical properties of polymeric materials are strongly influenced by time, temperature, load and rate of motion. Highly complex intermolecular processes affect the stress relaxation and retardation phenomena. Furthermore, the tribology of the system (e.g. friction and wear) has a strong influence on the seal material properties and vice versa. Therefore, state of the art sealing systems can only be developed by close cooperation between material experts and product designers, supported by advanced design tools like non-linear FEA and extensive seal testing capabilities.

SKF has a global material development organization that closely cooperates with the product development and testing functions. SKF is uniquely suited to develop, simulate, test and manufacture tailor-made materials for specific customer needs.

The following tables outline the most common materials used by SKF for serial production of hydraulic seals, including those materials used for products highlighted in this catalogue. A wide variety of additional seal materials are available for special hydraulic seals or other seal applications.

### Thermoplastic elastomers

SKF has a long history in developing and supplying special polyurethane grades for sealing purposes. SKF manufactures the well-known ECOPUR family of polyurethanes including H-ECOPUR for outstanding chemical and hydrolysis resistance, X-ECOPUR for extrusion resistance or S-ECOPUR for low friction and resistance to wear.

Polyurethanes combine the elastic properties of elastomers with the processability of thermoplastic materials. Seals made of polyurethanes provide excellent wear and pressure resistance and avoid leakage. Special sealing polyurethane grades have a superior compression set and relaxation performance as well as temperature stability compared to commodity industrial grades. Due to their elasticity and flexibility, they are easy to install.

**Table 4 (→ page 28)** lists common thermoplastic elastomers.

## Rubbers

Rubbers are widely used in the seals industry for rotary shaft seals, static sealing elements such as O-rings and energizers, as well as dynamic seals in the fluid power industry. Depending on the chemical composition, rubbers can cover a wide temperature range up to 200 °C (390 °F) and more and withstand a wide variety of hydraulic fluids. NBR elastomers in a hardness range from 70 to 90 Shore A are the most commonly used rubbers in the fluid power industry. For higher temperatures and more aggressive hydraulic fluids, SKF recommends HNBR or FKM elastomers.

**Table 5 (→ page 29)** lists common rubbers.

## PTFE

PTFE is a polymer with very unique properties. Due to its chemical composition, it is the plastic material with the highest chemical resistance and the lowest coefficient of friction, however, it has some restrictions in terms of mechanical properties and wear. Therefore, PTFE is very often modified by adding various inorganic and organic fillers to improve specific properties such as wear or extrusion resistance.

One of the most important characteristics of PTFE is the low coefficient of friction in combination with outstanding stick-slip performance. Therefore, PTFE is the preferred material in applications that require accurate positioning of hydraulic cylinders. Due to the increased modulus of elasticity compared to rubbers and polyurethanes, PTFE seals can usually not be installed by simple snap-in procedures and require special tools and procedures for installation.

**Table 6 (→ page 29)** lists common PTFE materials.

## Rigid thermoplastics and thermosets

Rigid thermoplastics and thermosets and their composites are characterized by much higher hardness and stiffness as well as reduced elasticity compared to polyurethanes, rubbers or PTFE. Therefore, they are used for components where mechanical strength is more important than flexibility, such as guide rings, anti-extrusion rings or special piston seal arrangements for heavy duty applications.

SKF offers rigid thermoplastics and composites in a wide variety of homogenous (un-

filled or “virgin”) grades (e.g. POM or PA), filled grades (e.g. glass-fibre reinforced PA) and fabric-reinforced composites (e.g. phenolic resin with cotton fabric, PF). For extreme conditions, SKF can provide high performance materials such as PEEK (polyetheretherketone).

**Table 7 (→ page 30)** lists common rigid thermoplastic and thermosets.













Table 4

Thermoplastic elastomers (TPU and TPC)

Material code	Material description	Hardness		Colour <sup>1)</sup>	Example uses
		Shore A	Shore D		
LUBRITHANE U-1003	TPU	95		 black	Rod seals, piston seals, wiper seals
LUBRITHANE U-1023	TPU	93		 blue	Rod seals, buffer seals, piston seals, wiper seals
LUBRITHANE U-1029	TPU	94		 light blue	Rod seals, buffer seals, piston seals, wiper seals
PU54/199	TPU	97	54	 blue	LPV piston seal slide rings (for light or medium duty cylinders)
W93	TPU	93		 white	Press-in wiper seals
Y95A	TPU	95		 yellow	Back-up rings for O-rings
395A	TPU	98		 black	Back-up rings for O-rings
B93	TPU	93		 blue	Rod seals (for light or medium duty cylinders)
ECOPUR	TPU	95	48	 green	Premium U-cup seals, lip seals, wiper seals and chevron packings (for heavy duty cylinders)
X-ECOPUR	TPU with increased hardness and extrusion resistance	97	57	 dark green	Rod and buffer seals (for heavy duty cylinders)
X-ECOPUR PS	TPU with increased hardness and extrusion resistance	98	60	 green	Piston seals for heavy duty hydraulic applications
H-ECOPUR	TPU with increased chemical resistance against biodegradeable and water based fluids	95	48	 red	Rod and piston seals for applications requiring hydrolysis resistance, increased chemical resistance or conformance with FDA regulations
XH-ECOPUR	TPU with increased chemical resistance and higher hardness	97	60	 dark red	Rod and piston seals for applications requiring hydrolysis resistance, increased chemical resistance or conformance with FDA regulations
FLUOROTREL F-1504	TPC		55	 turquoise	Loaded rod seals, piston seals, back-up rings
S-ECOPUR	TPU with improved tribological characteristics	95	48	 dark grey	Rod and piston seals for water hydraulics, non-lubricated pneumatics or dry-running conditions
TPC-ET727/075	TPC		72	 black	MD-L piston seal support ring (for light or medium duty cylinders)
TPC-ET55/161	TPC		95	 cream	Back-up rings for O-rings



<sup>1)</sup> The colour examples may deviate from the actual colour of the material.

Table 5

Rubbers				
Material code	Material description	Hardness Shore A	Colour <sup>1)</sup>	Example uses
A-8501	NBR	70	 black	Rod seals, piston seals, moulded energizers
A-8504	NBR-LT (low temperature grade)	70	 black	Rod seals, piston seals, moulded energizers
A-8526	NBR	90	 black	SCP piston seal energizer
C-7021	HNBR	70	 black	Rod seals, piston seals, moulded energizers
C-7022	HNBR	80	 black	Rod seals, piston seals, moulded energizers
V-7501	FKM	70	 black	Piston seals
V-7503	FKM	90	 black	Rod seals, piston seals, moulded energizers
N70/6015	NBR	70	 black	CUT piston seal energizer
N70/6052	NBR	70	 black	O-rings and energizers
N80/6047	NBR	80	 black	Piston seals
N80/6198	NBR	80	 black	Energizers for heavy duty applications
SKF Ecorubber-1	NBR	85	 black	U-cup seals, chevron packings, machined seals
SKF Ecorubber-2	FKM based on fluororubber	85	 brown	U-rings, lip seals, chevron packings, wipers
SKF Ecorubber-H	HNBR	85	 black	U-cup seals, chevron packings, machined seals

<sup>1)</sup> The colour examples may deviate from the actual colour of the material.















Table 6

PTFE materials				
Material code	Material description	Hardness Shore D	Colour <sup>1)</sup>	Example uses
MS-292	PTFE + 40% bronze + MoS <sub>2</sub>		 brown-grey	Piston seal slide rings, guide strips
SKF Ecoflon 1	PTFE unfilled	57	 white	Anti-extrusion rings, chevron sets, O-rings, food-compatible products (FDA certificate)
SKF Ecoflon 2, 702	PTFE + 15% glass fibres + 5% MoS <sub>2</sub>	60	 grey	Anti-extrusion rings, chevron sets, O-rings
SKF Ecoflon 3, 741	PTFE + 40% bronze	65	 brown	Anti-extrusion rings, chevron sets, O-rings
SKF Ecoflon 4	PTFE + 23% hard carbon + 2% graphite	65	 black	Anti-extrusion rings, chevron sets, O-rings

<sup>1)</sup> The colour examples may deviate from the actual colour of the material.

Table 7

**Rigid thermoplastics and thermosets**

Material code	Material description	Colour <sup>1)</sup>	Example uses
707	PA 6	 black	Anti-extrusion rings
P-2501	PA 6.6 + 30% glass fibres (PA 6.6 GF30)	 black	Split piston seal slide rings
P-2506	PA 6.12	 black	Anti-extrusion rings
P-2551	PA 6 + 40% glass fibres (PA 6 GF40)	 grey	Guide rings and split piston seal slide rings
P-2552	PA 6 + 40% glass fibres + PTFE (PA 6 GF40 lubricated)	 black	Guide rings
PA 66/6011	PA 6.6 + 20% glass fibres (PA 6.6 GF20)	 black	Split piston seal slide rings
POM/076	POM	 red	Guide rings in compact sets (light and medium duty cylinders)
POM/GL/077	POM, glass fibre reinforced (POM GF)	 black	Guide rings (light and medium duty cylinders)
PF	Phenolic resin with cotton fabric	 brown	Guide rings
426	UHMWPE (ultra-high-molecular-weight polyethylene)	 white	Wiper seals type P02
SKF Ecomid	PA 6	 black	Anti-extrusion rings, guide rings
SKF Ecotal, 728	POM	 black	Anti-extrusion rings, guide rings and scraper wipers
SKF Ecopaek	PEEK	 beige	Anti-extrusion rings, guide rings
SKF Ecowear 1000	UHMWPE (ultra-high-molecular-weight polyethylene)	 white	Anti-extrusion rings, guide rings
SKF Ecotex	Polyester resin with polyester fabric and graphite filler	 light orange	Guide rings

<sup>1)</sup> The colour examples may deviate from the actual colour of the material.



## Hydraulic fluids

Fluids used in hydraulic systems serve multiple functions for the system performance:

- transfer power by flow under pressure acting on moveable surfaces
- lubricate surfaces in contact and relative motion – hydraulic cylinder components and seals, as well as other system components such as pumps and valves
- prevent corrosion of components
- cool the system, by carrying heat from areas of high load, motion or turbulence and spread it to the entire volume of the system including reservoir tanks and cooling equipment
- clean the system by carrying contaminants and wear particles to filter bodies or settling areas

The fluids used in hydraulic systems come in various chemical compositions and viscosity grades as suited to specific applications.

Viscosity is a measurement of the thickness of a fluid or the resistance to flow. Seal performance is affected by the viscosity of the fluid and changes to the viscosity during use. Most typical hydraulic fluids exhibit decreased viscosity with increasing temperature and increased viscosity with increasing pressure.

The most commonly used media in hydraulic systems are mineral oil based fluids with various additives. However, a variety of alternative fluids may be encountered in special applications. For example, biodegradable fluids such as synthetic (HEES) or natural esters (HETG) and polyalphaolefines (PAO) may be used to reduce environmental impact in the event of accidental spills. Flame retardant fluids based on water or synthetic esters may be safely used in confined spaces or where the hydraulic system is used in close proximity to ignition sources. The data, specifications and recommendations in this catalogue are for common mineral oil fluids. For guidance on specifications of sealing systems for alternative fluids, contact SKF.

The chemical composition of hydraulic fluids can impact the seal life and performance depending on compatibility with the seal material(s). Absorption and reaction of the seal material(s) with non-compatible fluids can cause, for example:

- changes in seal material volume – increased “swelling” or decreased “shrinking” and their respective impacts on seal contact force and friction
- hardening and embrittlement of the seal material
- softening, loss of strength or dissolving of the seal material
- degradation of the polymer chains or cross-linking, causing the material to fatigue or lose resilience
- discoloration of the seal material

Generally, these changes are accelerated by higher temperature. To avoid these changes and the resulting damage to seal function and life, careful consideration should be taken to ensure compatibility between the fluid and all seal materials, as well as the temperature and mechanical loads on the seal material. SKF has a long history and extensive database of test results concerning compatibility of various seal materials and fluids, as well as unparalleled expertise in developing materials to meet customers' needs for chemical resistance of seal materials.

**Table 8 (→ page 32)** summarizes the compatibility rating for the most important fluids and materials used in the fluid power industry. For materials not listed, contact SKF. **Table 8** provides general guidelines for new, clean fluids. Fluids vary by manufacturer, additives and contaminant levels. Materials vary by specific compound. The guidelines cannot substitute for testing the compatibility of a seal in the actual fluid and under actual operating conditions. Temperatures higher than specified in **table 8** can lead to degradation of the basic fluid or its additives. This can cause deterioration of the seal material. For applications where higher temperatures are required, contact SKF.

In addition to the specified hydraulic fluid, seal materials can be attacked by exposure to other fluids from other parts of systems (e.g. greases, fuels, coatings), environmental factors (e.g. humidity or radiation) and degradation and reaction with the fluids, additives and contaminants in the system producing additional chemicals.

## General technical information

### Hydraulic fluids and seal material compatibility

Fluid	Thermoplastic elastomers				Ether-based TPU		TPC (≥ 95 shA)	
	ECOPUR, LUBRITHANE		H-ECOPUR XH-ECOPUR		Normal	High	Normal	High
	Temperature Normal	High	Normal	High				
<b>Hydraulic fluids</b>	≤ 60 °C (≤ 140 °F)	≤ 100 °C (≤ 210 °F)	≤ 60 °C (≤ 140 °F)	≤ 100 °C (≤ 210 °F)	≤ 60 °C (≤ 140 °F)	≤ 100 °C (≤ 210 °F)	≤ 60 °C (≤ 140 °F)	≤ 100 °C (≤ 210 °F)
Mineral oils HL, HLP, HVLP	A	B	A	A	A	B/C	A	A/B
ATF (automatic transmission fluids)	A	B	A	A	A	B/C	A	B
HETG (Triglycerides, rape seed oil)	A	B/C	A	A	A	C	A	B/C
HEES (synthetic esters)	A	B/C	A	A	A	C	A	B/C
HEPG (Polyalcyline glycols)	B	D	A	C	B/C	D	C	D
HEPR (Polyalphaolefines)	A	B	A	A	A	B/C	A	B
<b>Fire resistant fluids, water-based</b>	≤ 40 °C (≤ 105 °F)	≤ 60 °C (≤ 140 °F)	≤ 40 °C (≤ 105 °F)	≤ 60 °C (≤ 140 °F)	≤ 40 °C (≤ 105 °F)	≤ 60 °C (≤ 140 °F)	≤ 40 °C (≤ 105 °F)	≤ 60 °C (≤ 140 °F)
Water	B	D	A	A	A	B	A	B
HFA-fluids (oil in water)	B	D	A	A	B	B/C	A	B
HFB-fluids (water in oil)	B	D	A	A	B	D	A	B
HFC-fluids (water-glycol)	C	D	A	B/C	B	B/C	C	D
<b>Fire resistant fluids, water-free</b>	≤ 60 °C (≤ 140 °F)	≤ 100 °C (≤ 210 °F)	≤ 60 °C (≤ 140 °F)	≤ 100 °C (≤ 210 °F)	≤ 60 °C (≤ 140 °F)	≤ 100 °C (≤ 210 °F)	≤ 60 °C (≤ 140 °F)	≤ 100 °C (≤ 210 °F)
HFD-R fluids	D	D	D	D	D	D	D	D
HFD-U fluids (polyol and carboxylic esters)	B	D	A	A	B	D	A	B/C
<b>Mineral greases</b>	A	B	A	A	A	B	A	A

A	Excellent
B	Good
C	Limited
D	Not recommended

1) Ethylene-propylene rubber for reference only – not common for hydraulic cylinders

2) For filled PTFE, compatibility of filler must be considered separately (e.g. bronze not recommended for water-based fluids).

3) Exposure to water-based fluids or moisture causes swelling.

4) Contact SKF

Table 8

Rubbers		FKM			EPDM <sup>1)</sup>	Thermoplastics and thermosets			PTFE <sup>2)</sup>
NBR, HNBR					PA, PF	PM	PEEK		
Temperature		Normal	High	All	Temperature				
Normal	High				All	All	All	All	

$\leq 60^\circ\text{C}$  ( $\leq 140^\circ\text{F}$ )     $\leq 100^\circ\text{C}$  ( $\leq 210^\circ\text{F}$ )     $\leq 60^\circ\text{C}$  ( $\leq 140^\circ\text{F}$ )     $\leq 100^\circ\text{C}$  ( $\leq 210^\circ\text{F}$ )

A	A	A	A	D
A	A	A	A	D
A/B	A/B	A	A	D
A/B	A/B	A	A	D
A	A/B	A/B	C/D	A
A/B	A/B	A	A	D

A	A	A	A
A	A	A	A
A	A	A	A
A	A	A	A
A	A	A	A
A	A	A	A

$\leq 40^\circ\text{C}$  ( $\leq 105^\circ\text{F}$ )     $\leq 60^\circ\text{C}$  ( $\leq 140^\circ\text{F}$ )     $\leq 40^\circ\text{C}$  ( $\leq 105^\circ\text{F}$ )     $\leq 60^\circ\text{C}$  ( $\leq 140^\circ\text{F}$ )

A	A	A	A	A
A	A	A	B	D
A	A	A	A	D
A	A	A/B	B/C	A

C <sup>3)</sup>	A	A	A
C <sup>3)</sup>	A	A	A
C <sup>3)</sup>	A	A	A
C <sup>3)</sup>	A	A	A

$\leq 60^\circ\text{C}$  ( $\leq 140^\circ\text{F}$ )     $\leq 100^\circ\text{C}$  ( $\leq 210^\circ\text{F}$ )     $\leq 60^\circ\text{C}$  ( $\leq 140^\circ\text{F}$ )     $\leq 100^\circ\text{C}$  ( $\leq 210^\circ\text{F}$ )

D	D	A/C <sup>4)</sup>	A/C <sup>4)</sup>	A
A/B	C	A	A	D

A	A	A	A
A	A	A	A

A	A	A	A	D
---	---	---	---	---

A	A	A	A
---	---	---	---

## Gap extrusion

The process by which seal material is forced into the clearances between components is called gap extrusion. The dimension of this clearance gap is referred to as the extrusion gap, or “e-gap” (→ fig. 4).

The resistance of a given seal component to gap extrusion is mainly determined by the material composition and quality. Materials of greater hardness and stiffness typically also have improved resistance to extrusion. Therefore, anti-extrusion rings of materials harder than the seal material may be used to prevent seal extrusion into the e-gap (→ fig. 5).

Pressure is the main driver of extrusion, but the e-gap size and application temperature are also major factors. **Diagram 2** shows the pressure resistance of different materials as a function of temperature. The values were measured on an SKF test rig. The tests were carried out with a square ring seal, dimensions 38,7 x 49 x 5 mm under static pressure and an extrusion gap of 0,3 mm. The pressure values were taken at an extrusion length of 0,5 mm. While these sample values illustrate the differences in extrusion resistance for standard grades of typical seal materials, there are many variations of each basic composition that impact the extrusion resistance of seals. In addition, the profile design and the seal friction affect extrusion. For maximum allowable pressure, temperature and e-gap of each seal profile, refer to the profile data for each profile in the relevant chapters.

The maximum e-gap in a hydraulic cylinder is realized when the cylinder components are at the maximum radial misalignment of components. This misalignment is affected by:

- external forces acting upon the cylinder assembly (e.g. acceleration forces, frictional moments from rotation of cylinder end connections)
- the weight of the cylinder components (especially when mounted horizontally)
- deformation of cylinder components (rod flexing, guide ring radial deformation under force)
- the tolerance stack up of multiple cylinder components

Fig. 4

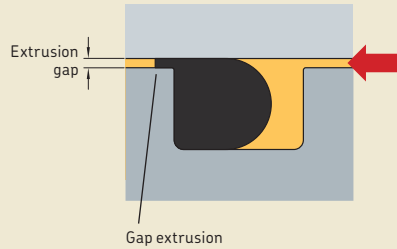

Fig. 5

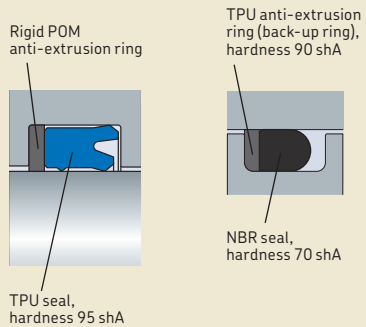

Diagram 2

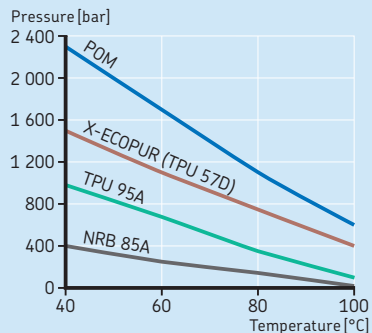
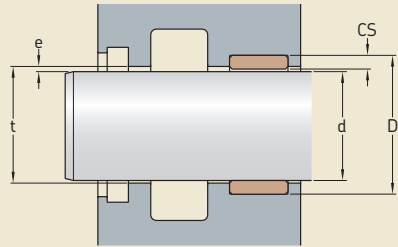

Fig. 6



Therefore, it is necessary to calculate the e-gap at the maximum misalignment at minimum material conditions of the cylinder and guide components.

For rod seals, the maximum e-gap should be calculated with the following conditions (→ **fig. 6**):

- guide ring groove at maximum diameter  $D$
- rod at minimum diameter  $d$
- guide ring cross section at minimum thickness  $CS$  (considering tolerances and any radial deformation of the guide ring under load)
- rod seal housing throat at maximum diameter  $t$

For piston seals, the maximum e-gap should be calculated with the following conditions (→ **fig. 7**):

- bore at maximum diameter  $D$
- guide ring groove at minimum diameter  $d$
- guide ring cross section at minimum thickness  $CS$  (considering tolerances and any radial deformation of the guide ring under load)
- piston seal housing at minimum outside diameter  $OD$

Fig. 7

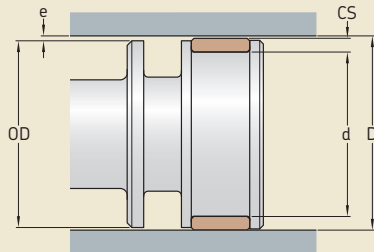

The maximum allowable e-gap is provided in the profile data for each rod seal and piston seal profile in the relevant chapter. The e-gap can be kept within these limits by specifying and controlling the tolerances of dimensions described above and shown in **figs. 6 and 7**.

### Storage

During storage, the properties of elastomer products can be damaged either by chemical reactions or by physical processes. Chemical reactions are basically caused by the influence of heat, light, oxygen, ozone or contamination by chemicals. The physical processes, which are called physical ageing, are either due to the influence of external stresses leading to cracks and permanent deformation, or due to the migration of plasticizers, which makes the material more brittle and can lead to deformation of the parts.

Therefore, elastomer products only maintain their characteristics for several years without major changes, if they are properly stored. The ageing behaviour of elastomer products and their reaction on storage conditions depend considerably on their chemical structure. Unsaturated elastomers (e.g. nitrile rubber) age more quickly under improper storage conditions than saturated elastomers (e.g. fluororubber).

### Storage conditions

Elastomer products should be stored in accordance with the following recommendations, which are in line with the recommendations provided in ISO 2230 or DIN 7716.

- Rubber and plastic products should be stored in a cool and dry room. The relative humidity should be < 65%. Storage temperature should be around 15 °C (60 °F) and not exceed 25 °C (75 °F). If the storage temperature is below 15 °C, care should be taken during handling of stored products because they may have stiffened. They should be warmed up slowly at ambient temperature.
- The storage room must not contain any ozone-producing devices, such as electric motors or high-voltage devices.
- Rubber and plastic products should not be exposed to direct sunlight or artificial light with a high UV content (bulbs are preferred to neon lamps).
- Rubber products should not be exposed to drafts. They should be stored in airtight packaging. The package material must not contain plasticizers. Polyethylene is the most suitable package material.
- Contact between rubber products of different compositions should be avoided.
- Contact between rubber and plastic products and chemicals or dangerous metals (e.g. copper, manganese) should be avoided.
- Rubber and plastic products should be stored as tension-free as possible, i.e. the parts should not be subject to tension, pressure or bending. Rubber products, especially seals, must not be hung on nails or tightly folded or rolled for reasons of space.

## Shelf life

When stored under the conditions mentioned above, elastomer products retain their typical properties for several years (→ **table 9**).

The typical shelf life may be prolonged based on the actual product conditions at the end of the typical shelf life. Trained and experienced experts can approve a prolonged storage period based on a visual inspection of representative samples. The samples should not reveal any permanent distortion, mechanical damage or surface cracking. The material should not show any signs of hardening or softening nor any kind of tackiness.

Table 9

### Shelf life recommendations in years

Material	Typical shelf life	Possible prolongation
TPU, standard	5	2
ECOPUR, Lubrithane	5	2
H-ECOPUR, XH-ECOPUR	10	2
TPC (thermoplastic ether-ester block copolymers)	5	2
NBR	6	3
HNBR	8	4
FKM, FPM	10	4
EPDM	8	4
MVQ (silicone)	10	5
PTFE	15	5
PA, POM, PF	8	4
PEEK	15	5
UHMWPE	10	5

## Installation and assembly

### Seal housings

The type of seal housing determines the method of installation, required equipment and the degree of difficulty. There are four main types of seal housings.

#### Closed grooves

Closed grooves are the most common seal housings (→ **fig. 8**). They require the most planning and effort to ensure that the seal is installed properly without damage. Not all seal cross section sizes and material combinations can be installed into this type of seal housing.

#### Open grooves

Open grooves allow the seal to be pressed in with minimal deformation and are therefore a good choice when the seal design, material or size prevent installation into a closed groove. Some seals, such as press-in wipers, have metal components that retain the seal in an open groove by friction (→ **fig. 9**). Other seals may require an additional retaining device (→ **fig. 10**). Plastic retaining rings, such as RI for rods or RR for piston, are available from SKF on request. Open grooves require specified edge radii or chamfers to prevent seal damage when the seal enters the groove or passes the retaining ring groove.

#### Split two-piece closed grooves

These grooves incorporate two separable machine components to provide an open groove when the seal is installed and a closed groove when the machine is fully assembled (→ **fig. 11**).

#### Stepped grooves

Stepped grooves allow seals to be installed with less deformation (→ **fig. 12**). Snap-in wipers are a common example in hydraulic cylinder applications.

#### Corner radii

The corner radii inside the groove should be sized to avoid inadvertent contact with the adjacent portion of the seal. Static side corner radius recommendations are provided in the product tables of the relevant chapter.

Fig. 8

Closed groove

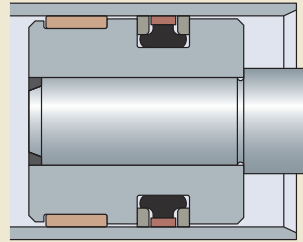

Fig. 9

Open groove

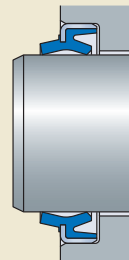
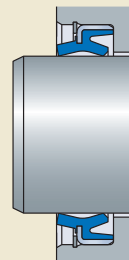

Fig. 10

Open groove and retainer





### Groove edge radii

All outside groove edges and any other edges that may come into contact with the seal during installation or use should be broken with a small radius. Otherwise, the sharp edge may damage the seal. Unless otherwise specified, all outside groove edges should have a radius of approximately 0,2 mm (0.008 in.).

Fig. 11

#### Split two-piece closed groove

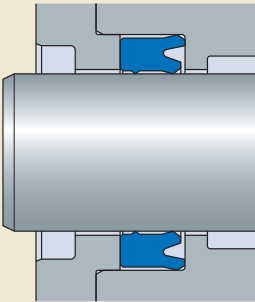

Fig. 12

#### Stepped groove



## General technical information

### Installation chamfers

Installation chamfers should be designed into the cylinder bore and on to the assembly end of the piston rod to ensure that the seal can easily transition from its free state diameter into its installed diameter. The installation chamfer should also be blended into the cylinder bore or piston rod diameter with a generous radius. The chamfer angle and minimum length recommendations are provided in the product tables of the relevant chapter.

### Installing rod seals

The method of installation and the possible groove types for rod seals depend on the materials, seal design and ratio between the diameter and cross-sectional height. **Table 10** provides general recommendations for profiles made of rubber or TPU with a hardness  $\leq 95$  shA. PTFE or other harder materials may require a smaller height  $S$  or even open grooves. The recommendations in **table 10** are not a substitute for careful installation trials in the particular application.

#### Installing rod seals in closed grooves

Rod seals can often be installed into closed grooves through carefully bending the profile similar to a kidney shape and then inserting it into the groove. It is very important to avoid sharp bending.

Thin and flexible profiles can be installed by hand ( $\rightarrow$  **figs. 13 a** and **b**). Mounting tools for TPU rod seals help to install profiles of greater section thickness ( $\rightarrow$  **figs. 14 a** to **f**). After installation, the seal may need to be calibrated to a round form using a cone-shaped calibration tool.

For PTFE seals, small diameter seals or for serial assembly, special assembly tools ( $\rightarrow$  **fig. 15**, page 42) may be required to save time or avoid seal damage. For additional information about such special installation tools, contact SKF.

Table 10

General recommendations for selecting the type of installation for rubber and TPU materials (hardness  $\leq 95$  shA)

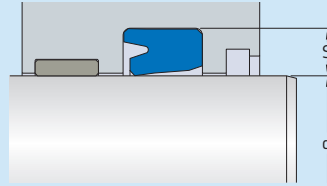

Diameter/height ratio	Type of installation
$d/S \leq 6$	Open groove
$6 < d/S \leq 10$	Closed groove, installation with tool
$d/S > 10$	Closed groove, installation by hand

Fig. 13 a

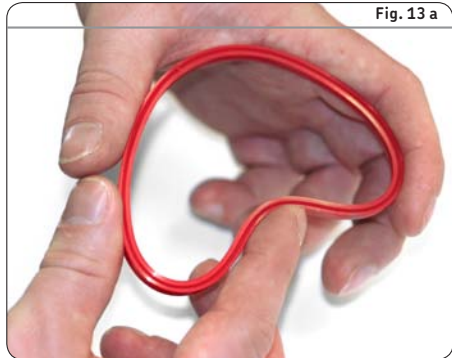
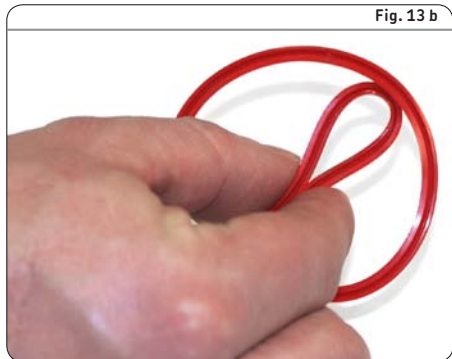

Fig. 13 b



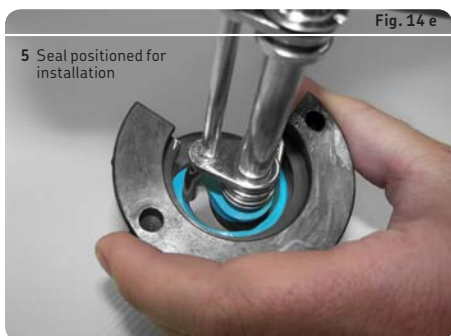
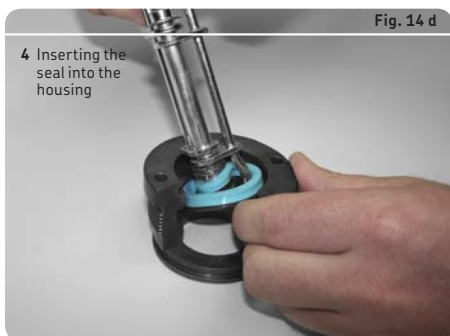
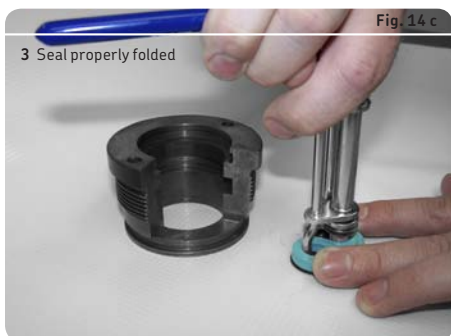
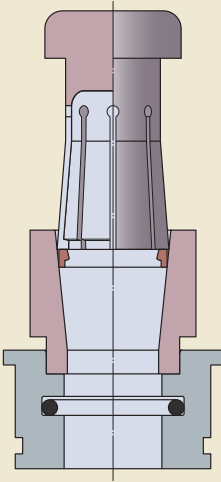

Fig. 15



## Installing piston seals

Piston seals installed in closed grooves must be expanded or stretched into position. Seals with step-cut slide rings such as CUT or SCP (→ *Piston seals with rigid split slide rings*, **page 54**) are relatively easy to expand into position. Continuous profiles should not be expanded to a material deformation of more than 20% for TPU or 30% for rubbers. Otherwise, the permanent deformation would be too large. Heating the seal, e.g. in an oil bath, decreases the required expansion force, but cannot increase the maximum material deformation.

Piston seals with a TPU slide ring can usually be installed by hand or with simple tools (→ **fig. 16**). PTFE seals or those with thicker radial sections may require special assembly tools to save time or avoid seal damage (→ **fig. 17**). For additional information about such special installation tools, contact SKF.

The recommendations cannot substitute for careful installation trials in the particular application.

Fig. 16

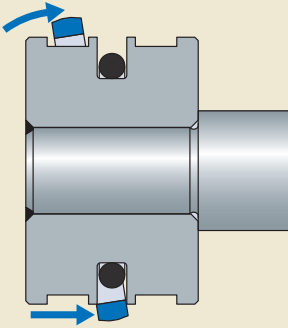
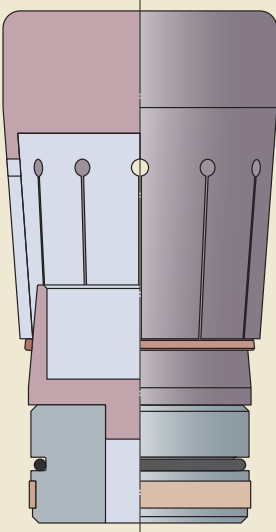

Fig. 17



## Installing wiper seals

Snap-in wiper seals, which are installed in stepped grooves (→ **fig. 12, page 39**), are typically of a small radial section per diameter and close to the end of the cylinder head component. Therefore, installation by hand is usually possible.

Press-in wipers require special equipment and careful planning for ease of installation without damaging the wiper seal or housing. Assembly tools adapted for each press-in wiper size should be used in conjunction with appropriate steady force in a hand operated press. Installation by impact (e.g. striking the assembly tool with a hammer) is not advised. The press assembly tool should be configured to stop when the wiper seal has been pressed flush with the groove edge (→ **fig. 18**). Pressing beyond flush can damage the wiper seal.

Fig. 18

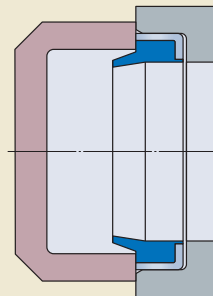

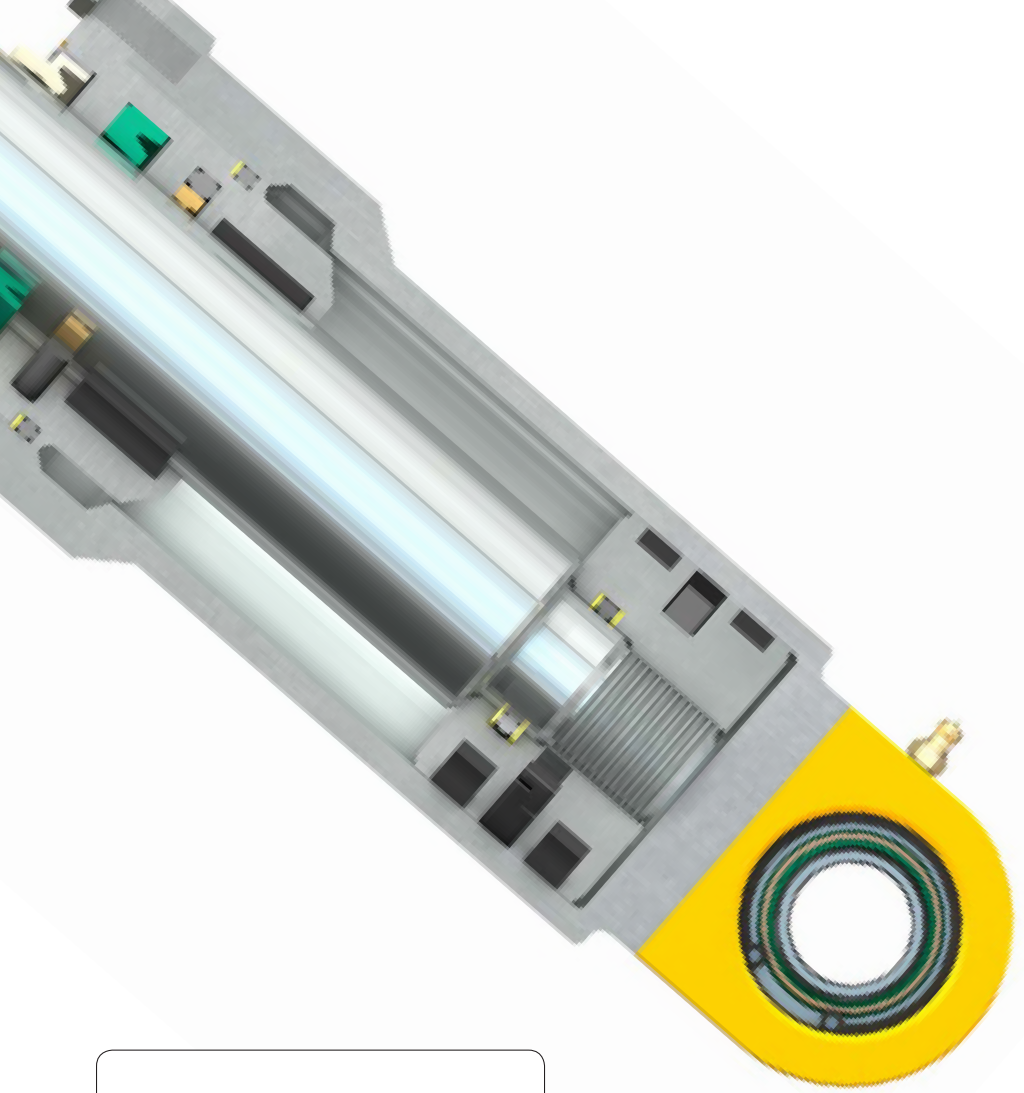









# Piston seals

<b>Profile overview</b> .....	<b>46</b>	<b>Profile data</b>	
<b>Basics</b> .....	<b>48</b>	<b>2.1</b> MPV .....	58
Materials .....	48	Metric sizes .....	59
Gap extrusion .....	48	<b>2.2</b> DPV .....	60
Piston guidance .....	48	Inch sizes .....	61
Piston drift .....	49	<b>2.3</b> LPV .....	62
Sealing between piston and rod .....	49	Metric sizes .....	63
<b>Double-acting piston seals</b> .....	<b>50</b>	<b>2.4</b> CPV .....	64
Piston seals with polyurethane		Inch sizes .....	65
slide rings .....	50	<b>2.5</b> GH .....	66
MPV profiles .....	50	Metric sizes .....	67
DPV profiles .....	51	Inch sizes .....	70
LPV profiles .....	51	<b>2.6</b> APR .....	76
CPV profiles .....	51	Metric sizes .....	77
Piston seals with PTFE slide rings .....	52	Inch sizes .....	79
GH profiles .....	52	<b>2.7</b> LCP .....	82
APR profiles .....	52	Metric sizes .....	83
Piston seals incorporating		Inch sizes .....	85
anti-extrusion rings .....	53	<b>2.8</b> LTP .....	86
LCP profiles .....	53	Inch sizes .....	87
LTP profiles .....	53	<b>2.9</b> CUT .....	90
Piston seals with rigid split slide rings .....	54	Metric sizes .....	91
CUT profiles .....	54	<b>2.10</b> SCP .....	94
SCP profiles .....	54	Inch sizes .....	95
Piston seals with integrated guide rings	55	<b>2.11</b> MD-L .....	98
MD-L profiles .....	55	Metric sizes .....	99
<b>Single-acting piston seals</b> .....	<b>56</b>	<b>2.12</b> UNP .....	102
UNP profiles .....	56	Metric sizes .....	103
Single-acting piston seals in		Inch sizes .....	105
double-acting cylinders .....	56	<b>More piston seals</b> .....	<b>108</b>
Rod seals used as single-acting		PTFE slide ring piston seals .....	108
piston seals .....	56	SPECTRASEAL .....	108
		Customized machined seal profiles .....	108



## Profile overview

Profile	Description	Additional information → page	Profile data → page
<b>MPV</b> 	Polyurethane slide ring, nitrile rubber energizer; suitable for heavy duty applications	<b>50</b>	<b>58</b> (metric)
<b>DPV</b> 	Polyurethane slide ring, nitrile rubber energizer; fits wide, shallow inch size housings; suitable for heavy duty applications	<b>51</b>	<b>60</b> (inch)
<b>LPV</b> 	Polyether based polyurethane slide ring, nitrile rubber energizer; suitable for light to medium duty applications	<b>51</b>	<b>62</b> (metric)
<b>CPV</b> 	Polyurethane slide ring, nitrile rubber energizer; fits wide, shallow inch size housings; suitable for light to medium duty applications	<b>51</b>	<b>64</b> (inch)
<b>GH</b> 	PTFE slide ring, nitrile rubber energizer; low breakaway friction	<b>52</b>	<b>66</b> (metric and inch)
<b>APR</b> 	PTFE slide ring with incorporated rubber X-ring, nitrile rubber energizer	<b>52</b>	<b>76</b> (metric and inch)
<b>LCP</b> 	PTFE slide ring supported by polyamide anti-extrusion rings, nitrile rubber energizer; very good gap extrusion resistance; suitable for high pressures	<b>53</b>	<b>82</b> (metric and inch)
<b>LTP</b> 	Sealing ring made of nitrile rubber, supported by polyamide anti-extrusion rings; good gap extrusion resistance; suitable for high pressures	<b>53</b>	<b>86</b> (inch)



Profile	Description	Additional information → page	Profile data → page
CUT 	Step cut polyamide slide ring, nitrile rubber energizer; suitable for high pressures	54	90 (metric)
SCP 	Step cut polyamide slide ring, oval nitrile rubber energizer; fits wide, shallow inch size housings; suitable for extreme pressures	54	94 (inch)
MD-L 	One-piece nitrile rubber sealing ring integrated polyester elastomer support rings and POM guide rings; common in older cylinder designs	55	98 (metric)
UNP 	Polyurethane U-cup profile; single-acting; may be used in double-acting cylinders when facing in opposite directions	56	102 (metric and inch)

### Rod seals that can be used as piston seals

PTB 	These rod seal profiles are designed with similar inside and outside sealing geometry and, therefore, can also be used as piston seals (→ <i>Rod seals used as single-acting piston seals</i> , page 56).	→ <i>Rod and buffer seals</i> , page 111	138
STD 			164
DZ 			178

### Basics

Piston seals (→ **fig. 1**) maintain sealing contact in sliding motion between the piston and the cylinder bore. Differential pressures acting on the piston to extend or retract the piston rod can be in excess of 400 bar (5 800 psi). The pressure acting on the piston seal increases contact forces between the piston seal and cylinder surface. Therefore, the surface properties of the sealing surfaces are critical to proper seal performance (→ *Counter-surface finish properties*, **page 22**).

Piston seals are typically classified into single-acting (pressure acting on one side only) and double-acting (pressure acting on both sides) seals.

### Materials

Depending on the profile and the required characteristics of its components, a piston seal can consist of one or several materials. Common materials used for piston seals are thermoplastic polyurethane (TPU), polytetrafluoroethylene (PTFE), polyamide (PA), and nitrile rubber (NBR). The materials used for a specific profile are provided in the *Profile overview* (→ **page 46**) and in the relevant profile sections below.

For additional information, refer to *Materials* (→ **page 26**).

#### More information

Counter-surface finish properties . . . . .	22
Materials . . . . .	26
Hydraulic fluids . . . . .	31
Gap extrusion . . . . .	34
Storage . . . . .	36
Installation and assembly . . . . .	38

Fig. 1

Typical piston seal arrangement for double-acting cylinders

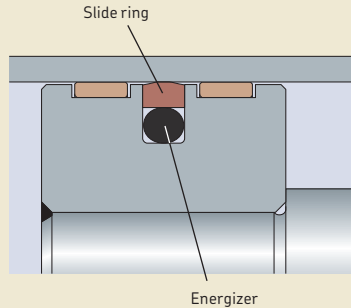

### Gap extrusion

External forces acting on the piston rod, reacted by the fluid inside the cylinder, can result in abrupt pressure peaks. These peaks can be far in excess of the system operating pressure and may press a piston seal into the gap between the piston and bore, thereby causing damage to the seal and adversely affecting seal performance and cylinder operation. Seal materials must be carefully chosen to avoid gap extrusion (→ *Gap extrusion*, **page 34**). This risk of gap extrusion can also be minimized by using seals with anti-extrusion rings (→ *Piston seals incorporating anti-extrusion rings*, **page 53**).

### Piston guidance

Guide rings avoid sliding metal-to-metal contact between the piston and cylinder bore and accommodate the radial loads of forces acting on the cylinder assembly. Although piston seals are designed to accommodate slight radial motion between the piston and bore, effective guide ring function to accurately centre the piston within the bore is important for piston seal performance. For additional information about piston guidance, refer to *Guide rings and guide strips* (→ **page 249**).

## Piston drift

When the piston rod is at rest and held in position by fluid, any amount of flow passing the piston can result in an unintended movement of the piston rod and cause drift. Although piston seal leakage is a possible source of drift, internal valve leakage, external system leakage and flow between the piston and rod static connections should also be carefully checked. In some applications, a minimal amount of flow passing the piston seal within specified limits is permitted. This tolerance allows the use of piston seals of low friction designs and materials or split slide rings for simple installation.

### Sealing between piston and rod

The piston can be welded to the rod (→ **fig. 2**) if the disassembly of the cylinder can be done by removing the rod end attachment. The piston can also be fixed to the rod end by a lock nut (→ **fig. 3**), which enables removing the piston from the rod during complete disassembly of the cylinder. When using a lock nut, static sealing (→ *O-rings and back-up rings*, **page 291**) is required between the piston and the rod end.

Fig. 2

Piston welded to the rod end tap

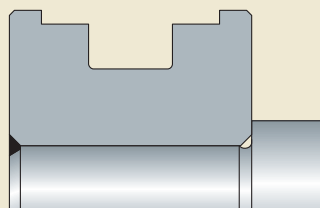
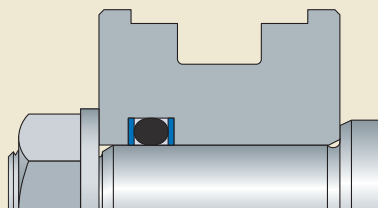

Fig. 3

Piston fixed to the rod by a lock nut and with a static seal and two back-up rings between piston and rod end



## Double-acting piston seals

Double-acting cylinders are the most widely used cylinder types. They operate with pressure on both sides and, therefore, require double-acting seal arrangements (→ **fig. 1**, **page 48**).

Double-acting piston seals have a symmetrical profile (cross section) and identical sealing functions in both directions. Typically, double-acting piston seals consists of a slide ring and an energizer. The deformation of the rubber energizer when installed provides adequate force to keep the slide ring in dynamic sealing contact with the cylinder bore, while sealing statically against the seal housing groove.

A double-acting cylinder typically has the same fluid on both sides of the piston. Therefore, a relatively thick lubrication film can be permitted between the piston seal and the cylinder bore to minimize friction and wear. The transportation of fluid occurring during dynamic operation is, however, small and insignificant in most applications.

SKF supplies double-acting piston seals in many different profiles and in a wide range of series and sizes, which make them appropriate for a wide variety of operating conditions and applications.

## Piston seals with polyurethane slide rings

Piston seals with thermoplastic polyurethane (TPU) slide rings have a nitrile rubber (NBR) energizer. The wear-resistant slide ring has a profiled dynamic sealing surface optimized to reduce friction and resist gap extrusion. Notches in the slide ring edges ensure rapid pressurization of the seal to react to abrupt changes in pressure. These profiles can usually be installed without special equipment and are resistant to damage during installation and cylinder assembly.

### MPV profiles

MPV profiles (→ **fig. 4**) have slide rings made of hard X-ECOPUR PS (TPU) developed for pressures up to 400 bar (5 800 psi). They are suitable for high fluid temperatures and in heavy duty applications, such as earthmoving equipment. MPV profiles are available in metric sizes and some fit seal housings in accordance with ISO 7425-1.

Fig. 4

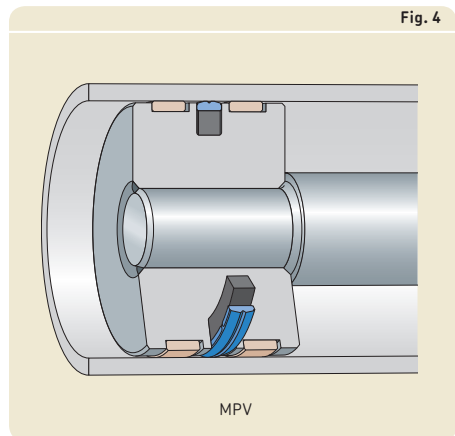

Fig. 5

**DPV profiles**

DPV profiles (→ **fig. 5**) have slide rings made of hard X-ECOPUR PS (TPU) developed for pressures up to 400 bar (5 800 psi). They are suitable for high fluid temperatures and for heavy duty applications, such as earthmoving equipment. DPV profiles are available in inch sizes where wider, shallower seal housings are used.

**LPV profiles**

LPV profiles (→ **fig. 6**) have a polyether base polyurethane (EU) slide ring that provides resistance to hydrolysis (attack from moisture) and good low temperature flexibility. The O-ring energizer provides a cost-effective sealing solution. These profiles are developed for pressures up to 250 bar (3 625 psi) and suitable for light to medium duty applications, such as agriculture and material handling applications. They are available in metric sizes.

**CPV profiles**

CPV profiles (→ **fig. 7**) have a polyester base polyurethane (AU) slide ring. These profiles are developed for pressures up to 345 bar (5 000 psi) and suitable for light to medium duty applications. They are available in inch sizes where wider, shallow seal housings are used.

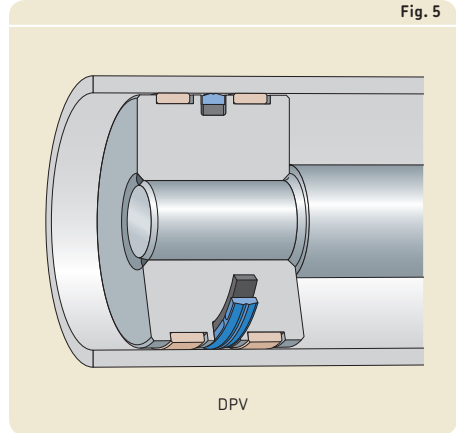

Fig. 6

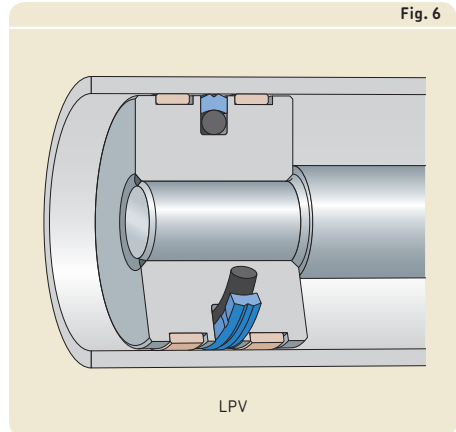
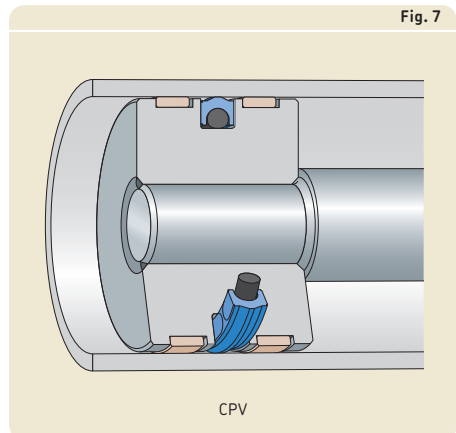

Fig. 7



## Piston seals

### Piston seals with PTFE slide rings

PTFE slide rings may be preferred in applications with demands for low breakaway friction and when it comes to chemical and thermal resistance. Notches in the slide ring edges ensure rapid pressurization of the seal to react to abrupt changes in pressure. PTFE is hard and non-elastic when compared with polyurethane and rubber materials. Therefore, PTFE slide rings are combined with an energizer that provides the necessary sealing force and the static sealing function in the seal housing. For additional information about piston seal materials, refer to *Materials* (→ page 48).

#### GH profiles

GH profiles (→ fig. 8) have a nitrile rubber (NBR) energizer, which is an O-ring as standard. Square ring expanders are available on request. These profiles are suitable for pressures up to 400 bar (5 800 psi) and are available in metric and inch sizes. Some metric sizes fit seal housings in accordance with ISO 7425-1.

#### APR profiles

APR profiles (→ fig. 9) have a nitrile rubber (NBR) O-ring energizer. The PTFE slide ring incorporates a NBR X-ring to improve sealing performance. They are suitable for pressures up to 350 bar (5 075 psi) and are available in metric and inch sizes. Some metric sizes fit seal housings in accordance with ISO 7425-1.

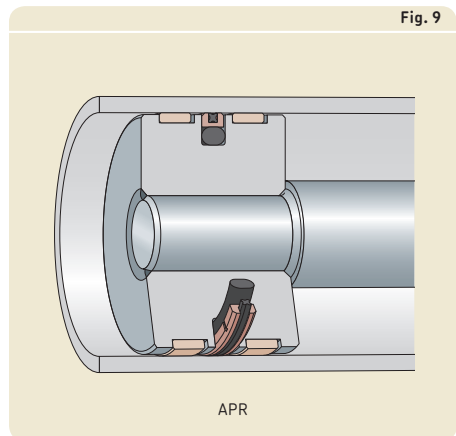
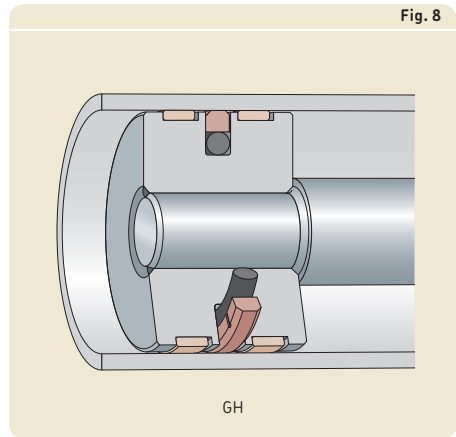

Fig. 10

## Piston seals incorporating anti-extrusion rings

These SKF piston seals incorporate patented locking anti-extrusion rings (→ **fig. 10**) made of polyamide (PA). They are split for simple installation. Their snap-in design makes it easy to identify the correct mounting direction, holds them in place when mounted and prevents damage during assembly. For additional information about mounting and assembly, refer to *Installation and assembly* (→ **page 38**).

Piston seals incorporating anti-extrusion rings have an improved high pressure performance and minimize the risk of gap extrusion at abrupt pressure peaks (→ *Gap extrusion*, **page 48**).

### LCP profiles

LCP (→ **fig. 11**) profiles have a PTFE slide ring supported by harder PA anti-extrusion rings (→ **fig. 10**) and a nitrile rubber (NBR) energizer. These capped T-seals are suitable for pressures up to 690 bar (10 000 psi) and available in various industry common metric and inch sizes. Some metric sizes fit seal housings in accordance with ISO 5597.

### LTP profiles

LTP profiles (→ **fig. 12**) have a nitrile rubber (NBR) sealing ring supported by harder PA anti-extrusion rings on both sides. The sealing ring serves as a slide ring and also seals statically against the seal groove. These T-seals are suitable for pressures up to 345 bar (5 000 psi) and are available in inch sizes.

### Patented locking anti-extrusion rings

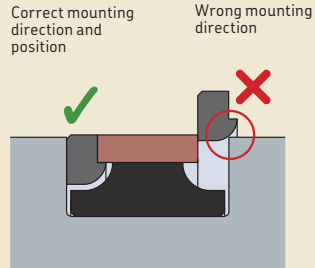
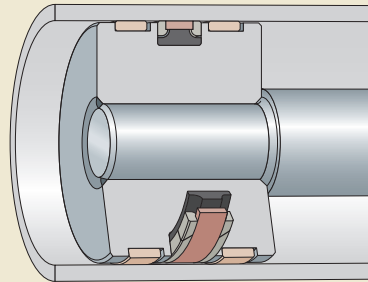
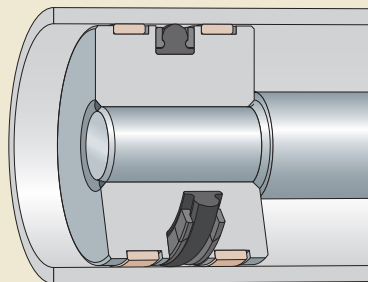

Fig. 11



LCP

Fig. 12



LTP

## Piston seals

### Piston seals with rigid split slide rings

These SKF piston seals have a rigid split slide ring made of glass fibre reinforced polyamide (GFR PA) and a nitrile rubber (NBR) energizer. The rigid slide ring has high resistance to wear and gap extrusion and provides low friction, even under high pressure. The split slide ring design facilitates the mounting process into a closed seal housing.

#### CUT profiles

CUT profiles (→ **fig. 13**) have a step cut slide ring and a rectangular energizer. They are suitable for pressures up to 500 bar (7 250 psi). They can be used for short pressure pulses up to 1 000 bar (14 500 psi) with proper system design. For additional information, contact SKF. These profiles are available in metric sizes and some fit seal housings in accordance with ISO 7425-1.

#### SCP

SCP profiles (→ **fig. 14**) have a step cut slide ring and an oval energizer. They are suitable for pressures up to 690 bar (10 000 psi). SCP profiles are available in inch sizes where wider, shallower seal housings are used.

Fig. 13

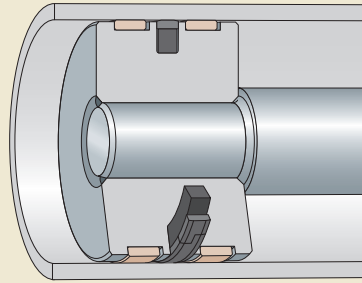

CUT

Fig. 14

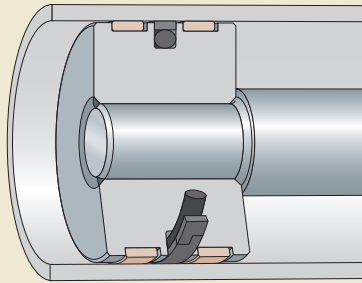

SCP



Fig. 15

### Piston seals with integrated guide rings

These seals are designed as compact sets that incorporate the piston seal and guide rings into one assembly. Typically, they are applied in older cylinder designs. For designing new cylinders, SKF recommends using guide rings and piston seals in separate grooves (→ *Guide rings and guide strips*, page 249).

#### MD-L profiles

MD-L profiles (→ **fig. 15**) have a nitrile rubber (NBR) sealing ring with polyester thermoplastic elastomer (TPC) support rings on both sides, which incorporate the POM guide rings. The sealing ring serves as a slide ring and also seals statically against the seal groove. The support rings protect the sealing ring against gap extrusion. The guide and support rings are split for simple installation. MD-L profiles are suitable for pressures up to 250 bar (3 625 psi) and are available in metric sizes. Some sizes fit seal housings in accordance with ISO 6547.

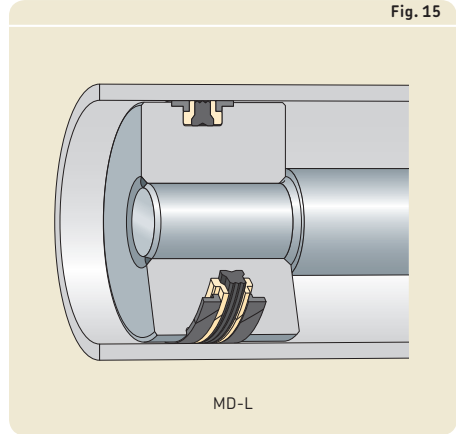

## Single-acting piston seals

A single-acting piston seal is designed for cylinders where pressure is applied from one side only. The piston in single-acting cylinders may have oil on the pressure side only, while the opposite side is open to atmosphere. Therefore, the piston seal must leave a minimum of oil film when passing along the cylinder bore since the transportation of oil otherwise would result in a leakage to the exterior.

In single-acting cylinders, the open end may push air out and draw air in as the piston reciprocates. This air may carry moisture and contaminants into the cylinder, which can lead to seal damage. Vent filters may be fitted to the open side of the cylinder to reduce contaminants entering the inside of the cylinder. The cylinder bore may be hard chromium plated to prevent corrosion.

In addition, to prevent damage to the cylinder bore or piston seals, SKF can supply special piston wiper seals on request. For additional information, contact SKF.

### UNP profiles

UNP profiles (→ **fig. 16**) are single-acting U-cup seals made of thermoplastic polyurethane (TPU). They are suitable for pressures up to 350 bar (5 075 psi) and are available in metric and inch sizes. Appropriate full-face anti-extrusion rings for these profiles, for example BUS profile, are not covered in this catalogue, but are available on request. For additional information, contact SKF.

Fig. 16

UNP profile piston seal with a wiper seal

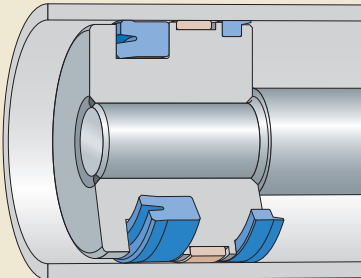

## Single-acting piston seals in double-acting cylinders

Two single-acting U-cup profile seals, facing in opposite directions, can be used in a double-acting cylinder. It is important to select seal designs which can relieve reverse pressure for such arrangements to prevent build-up of pressure between the two seals. UNP profiles are suitable for such double-acting arrangements because the dynamic seal lip can flex to relieve reverse pressure.

## Rod seals used as single-acting piston seals

Some rod seal profiles are designed with similar inside and outside sealing geometry and, therefore, can also be used as single-acting piston seals in single- or double-acting cylinders (→ **fig. 17**). PTB, STD and DZ rod seal profiles (→ *Rod and buffer seals*, **page 111**) can be used for those applications.

Rod seals with loaded-lip U-cup profiles may not relieve reverse pressure, but it is possible to remove their allow expander (X-ring) from one of the seals to allow reverse pressure relief (→ **fig. 17**).

Fig. 17

STD profiles used as piston seals (in a double-acting arrangement)

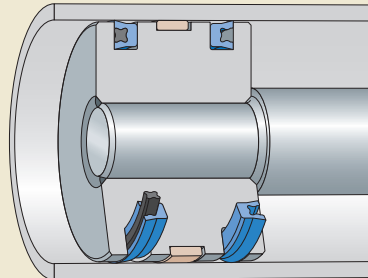



### MPV profile data



<b>Materials</b>	Slide ring: X-ECOPUR PS Energizer: NBR 80 shA For additional information → <b>page 26</b>
<b>Pressure</b>	Up to 400 bar (5 800 psi)
<b>Speed</b>	Up to 1 m/s (3.2 ft/s)
<b>Temperature range</b>	<p>For temperature limits depending on fluid compatibility → <b>table 8, page 32</b></p> <ul style="list-style-type: none"> <li><span style="color: blue;">■</span> Extreme low temperature range: may be intermittently exposed (e.g. cold start-up) without seal damage, but seal performance may be compromised while in this range</li> <li><span style="color: grey;">■</span> Temperatures below the recommended operating range: seal performance depends on system design (precision guiding arrangement recommended)</li> <li><span style="color: green;">■</span> <b>Recommended operating temperature range for this profile and material</b></li> <li><span style="color: yellow;">■</span> Temperatures above the recommended operating range: acceptable only with reduced pressure, speed, and/or e-gap</li> <li><span style="color: red;">■</span> Extreme high temperature range: only occasional short term exposure (e.g. cylinder in curing oven of a powder coating process)</li> </ul>
<b>Dimension standards</b>	Some sizes fit seal housings in accordance with ISO 7425-1.
<b>Counter-surface</b>	→ <b>page 22</b>

Maximum values of application parameters (e.g. pressure, speed, temperature, e-gap) should not be applied continuously nor simultaneously.

## 2.1 MPV profile piston seals, metric sizes

D 50 – 200 mm

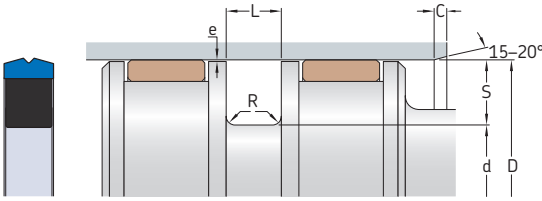

### Maximum extrusion gap e

Radial depth S  
 $e_{max}$  at 80 °C (175 °F)  
 for pressures 160 bar 250 bar 400 bar

mm	mm		
3,75	0,4	0,4	–
5,5	0,5	0,4	0,3
7,75	0,6	0,45	0,3
10,5	0,7	0,55	0,4

2.1

### Cylinder dimensions

### Designation

D H9	d h9	L +0,2	S	R max.	C min.	Designation
mm						–
50	34,5	6,3	7,75	1,3	5	• MPV-50x34.5x6.3
55	39,5	6,3	7,75	1,3	5	MPV-55x39.5x6.3
60	44,5	6,3	7,75	1,3	5	MPV-60x44.5x6.3
63	47,5	6,3	7,75	1,3	5	• MPV-63x47.5x6.3
65	49,5	6,3	7,75	1,3	5	MPV-65x49.5x6.3
70	54,5	6,3	7,75	1,3	5	MPV-70x54.5x6.3
75	59,5	6,3	7,75	1,3	5	MPV-75x59.5x6.3
80	59	8,1	10,5	1,8	6	MPV-80x59x8.1
85	64	8,1	10,5	1,8	6	MPV-85x64x8.1
90	69	8,1	10,5	1,8	6	MPV-90x69x8.1
100	79	8,1	10,5	1,8	6	MPV-100x79x8.1
110	89	8,1	10,5	1,8	6	MPV-110x89x8.1
120	99	8,1	10,5	1,8	6	MPV-120x99x8.1
125	104	8,1	10,5	1,8	6	MPV-125x104x8.1
130	109	8,1	10,5	1,8	6	MPV-130x109x8.1
150	129	8,1	10,5	1,8	6	MPV-150x129x8.1
160	139	8,1	10,5	1,8	6	• MPV-160x139x8.1
200	179	8,1	10,5	1,8	6	• MPV-200x179x8.1

Other sizes are available on request

• Seal housing dimensions in accordance with ISO 7425-1

## DPV profile data



<b>Materials</b>	Slide ring: X-ECOPUR PS Energizer: NBR 70 shA For additional information → <a href="#">page 26</a>
<b>Pressure</b>	Up to 400 bar (5 800 psi)
<b>Speed</b>	Up to 1 m/s (3.2 ft/s)
<b>Temperature range</b>	<p>For temperature limits depending on fluid compatibility → <a href="#">table 8, page 32</a></p> <ul style="list-style-type: none"> <li><span style="color: blue;">■</span> Extreme low temperature range: may be intermittently exposed (e.g. cold start-up) without seal damage, but seal performance may be compromised while in this range</li> <li><span style="color: grey;">■</span> Temperatures below the recommended operating range: seal performance depends on system design (precision guiding arrangement recommended)</li> <li><span style="color: green;">■</span> <b>Recommended operating temperature range for this profile and material.</b></li> <li><span style="color: yellow;">■</span> Temperatures above the recommended operating range: acceptable only with reduced pressure, speed, and/or e-gap</li> <li><span style="color: red;">■</span> Extreme high temperature range: only occasional short term exposure (e.g. cylinder in curing oven of a powder coating process)</li> </ul>
<b>Counter-surface</b>	→ <a href="#">page 22</a>

Maximum values of application parameters (e.g. pressure, speed, temperature, e-gap) should not be applied continuously nor simultaneously.

## 2.2 DPV profile piston seals, inch sizes

D 1 – 6.002 in.

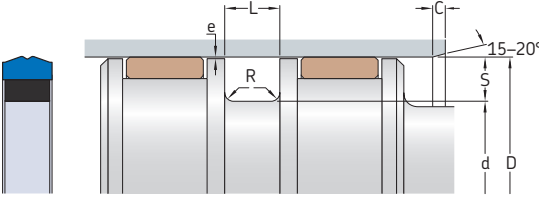

### Maximum extrusion gap e

Radial depth  
S  
in.

$e_{max}$  at 80 °C (175 °F)  
for pressures  
2 300 psi 3 600 psi 5 800 psi

in.	in.		
0.125	0.012	0.008	–
0.187	0.018	0.012	0.008
0.25	0.022	0.016	0.01

### Cylinder dimensions

### Designation

D +0.002	d	Tolerance	L +0.005	S	R max.	C min.	Designation
in.							–
1	0.758	–0.002	0.187	0.125	0.02	0.125	DPV-210-K0M
1.5	1.258	–0.002	0.187	0.125	0.02	0.125	DPV-218-K0M
1.75	1.508	–0.002	0.187	0.125	0.02	0.125	DPV-222-K0M
2	1.63	–0.002	0.281	0.187	0.025	0.156	DPV-326-K0M
2.25	1.88	–0.002	0.281	0.187	0.025	0.156	DPV-328-K0M
2.5	2.13	–0.002	0.281	0.187	0.025	0.156	DPV-330-K0M
2.75	2.38	–0.002	0.281	0.187	0.025	0.156	DPV-332-K0M
3	2.63	–0.002	0.281	0.187	0.025	0.156	DPV-334-K0M
3.5	3.13	–0.002	0.281	0.187	0.025	0.156	DPV-338-K0M
3.75	3.38	–0.002	0.281	0.187	0.025	0.156	DPV-340-K0M
4	3.63	–0.002	0.281	0.187	0.025	0.156	DPV-342-K0M
4.5	4.13	–0.002	0.281	0.187	0.025	0.156	DPV-346-K0M
5	4.63	–0.002	0.281	0.187	0.025	0.156	DPV-350-K0M
5.502	5.028	–0.004	0.375	0.25	0.032	0.187	DPV-429-K0M
6.002	5.528	–0.004	0.375	0.25	0.032	0.187	DPV-433-K0M

Other sizes are available on request

## LPV profile data



<b>Materials</b>	Slide ring: TPU 54 shD Energizer: NBR 70 shA For additional information → <a href="#">page 26</a>
<b>Pressure</b>	Up to 250 bar (3 625 psi)
<b>Speed</b>	Up to 0,5 m/s (1.6 ft/s)
<b>Temperature range</b>	<div style="display: flex; align-items: center;"> <div style="margin-right: 10px;">-60</div> <div style="margin-right: 10px;">-50</div> <div style="margin-right: 10px;">-40</div> <div style="margin-right: 10px;">90</div> <div style="margin-right: 10px;">100</div> <div style="margin-right: 10px;">110 [°C]</div> </div> <div style="display: flex; align-items: center; margin-top: 5px;"> <div style="margin-right: 10px;">-75</div> <div style="margin-right: 10px;">-60</div> <div style="margin-right: 10px;">-40</div> <div style="margin-right: 10px;">195</div> <div style="margin-right: 10px;">210</div> <div style="margin-right: 10px;">230 [°F]</div> </div> <p>For temperature limits depending on fluid compatibility → <a href="#">table 8, page 32</a></p> <ul style="list-style-type: none"> <li><span style="display: inline-block; width: 15px; height: 15px; background-color: #007bff; margin-right: 5px;"></span> Extreme low temperature range: may be intermittently exposed (e.g. cold start-up) without seal damage, but seal performance may be compromised while in this range.</li> <li><span style="display: inline-block; width: 15px; height: 15px; background-color: #6c757d; margin-right: 5px;"></span> Temperatures below the recommended operating range: seal performance depends on system design (precision guiding arrangement recommended)</li> <li><span style="display: inline-block; width: 15px; height: 15px; background-color: #28a745; margin-right: 5px;"></span> <b>Recommended operating temperature range for this profile and material</b></li> <li><span style="display: inline-block; width: 15px; height: 15px; background-color: #ffc107; margin-right: 5px;"></span> Temperatures above the recommended operating range: acceptable only with reduced pressure, speed, and/or e-gap</li> <li><span style="display: inline-block; width: 15px; height: 15px; background-color: #dc3545; margin-right: 5px;"></span> Extreme high temperature range: only occasional short term exposure (e.g. cylinder in curing oven of a powder coating process)</li> </ul>
<b>Dimension standards</b>	Some sizes fit seal housings in accordance with ISO 7425-1.
<b>Counter-surface</b>	→ <a href="#">page 22</a>

Maximum values of application parameters (e.g. pressure, speed, temperature, e-gap) should not be applied continuously nor simultaneously.



## 2.3 LPV profile piston seals, metric sizes

D 25 – 100 mm

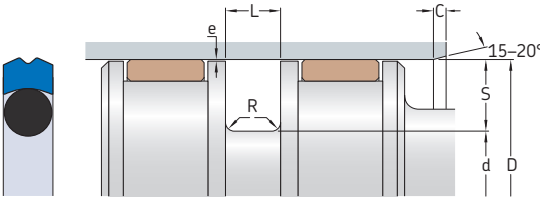

### Maximum extrusion gap e

Radial depth S	e <sub>max</sub> at 80 °C (175 °F) for pressures		
	160 bar	250 bar	400 bar
mm	mm		
3,75	0,3	0,2	–
5,5	0,4	0,25	–
7,75	0,4	0,3	–
10,5	0,5	0,4	0,3

2.3

### Cylinder dimensions

### Designation

D H9	d h10	L +0,2	S	R max.	C min.	
mm						–
25	17,5	3,2	3,75	0,5	2	• LPV 25x17.5x3.2
30	22,5	3,2	3,75	0,5	2	LPV 30x22.5x3.2
32	24,5	3,2	3,75	0,5	2	• LPV 32x24.5x3.2
35	24	4,2	5,5	0,5	2,5	LPV 35x24x4.2
40	29	4,2	5,5	0,5	2,5	• LPV 40x29x4.2
50	39	4,2	5,5	0,5	2,5	• LPV 50x39x4.2
55	44	4,2	5,5	0,5	2,5	LPV 55x44x4.2
60	49	4,2	5,5	0,5	2,5	LPV 60x49x4.2
63	52	4,2	5,5	0,5	2,5	• LPV 63x52x4.2
65	54	4,2	5,5	0,9	2,5	LPV 65x54x4.2
70	59	4,2	5,5	0,9	2,5	LPV 70X59X4.2
80	64,5	6,3	7,75	0,9	4	• LPV 80x64.5x6.3
90	74,5	6,3	7,75	0,9	4	LPV 90x74.5x6.3
100	84,5	6,3	7,75	0,9	4	• LPV 100x84.5x6.3

Other sizes are available on request

• Dimensions in accordance with ISO 7425-1

## CPV profile data



<b>Materials</b>	Slide ring: TPU U-1023 Energizer: NBR A-8501 For additional information → <b>page 26</b>
<b>Pressure</b>	Up to 345 bar (5 000 psi)
<b>Speed</b>	Pressure ≤ 250 bar (3 625 psi) → up to 1 m/s (3.2 ft/s) Pressure ≤ 345 bar (5 000 psi) → up to 0,5 m/s (1.6 ft/s)
<b>Temperature range</b>	<p>For temperature limits depending on fluid compatibility → <b>table 8, page 32</b></p> <ul style="list-style-type: none"> <li><span style="color: blue;">■</span> Extreme low temperature range: may be intermittently exposed (e.g. cold start-up) without seal damage, but seal performance may be compromised while in this range</li> <li><span style="color: grey;">■</span> Temperatures below the recommended operating range: seal performance depends on system design (precision guiding arrangement recommended)</li> <li><span style="color: green;">■</span> <b>Recommended operating temperature range for this profile and material</b></li> <li><span style="color: yellow;">■</span> Temperatures above the recommended operating range: acceptable only with reduced pressure, speed, and/or e-gap</li> <li><span style="color: red;">■</span> Extreme high temperature range: only occasional short term exposure (e.g. cylinder in curing oven of a powder coating process)</li> </ul>
<b>Counter-surface</b>	→ <b>page 22</b>

Maximum values of application parameters (e.g. pressure, speed, temperature, e-gap) should not be applied continuously nor simultaneously.

## 2.4 CPV profile piston seals, inch sizes

D 1.5 – 9.002 in.

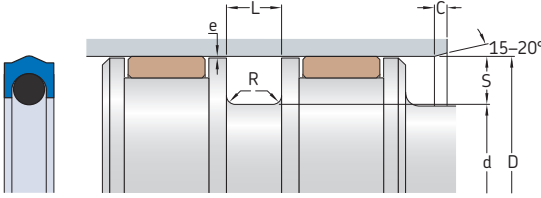

### Maximum extrusion gap e

Radial depth S	e <sub>max</sub> at 80 °C (175 °F) for pressures		
	2 300 psi	3 600 psi	5 000 psi
in.	in.		
0.121	0.008	0.006	–
0.185	0.012	0.008	0.004
0.237	0.014	0.01	0.006

### Cylinder dimensions

### Designation

D +0.002	d	Tolerance	L +0.005	S	R max.	C min.	Designation
in.							–
1.5	1.258	–0.002	0.187	0.121	0.02	0.125	CPV-218-J1S
1.75	1.508	–0.002	0.187	0.121	0.02	0.125	CPV-222-J1S
2	1.63	–0.002	0.281	0.185	0.025	0.156	CPV-326-J1S
2.25	1.88	–0.002	0.281	0.185	0.025	0.156	CPV-328-J1S
2.5	2.13	–0.002	0.281	0.185	0.025	0.156	CPV-330-J1S
2.75	2.38	–0.002	0.281	0.185	0.025	0.156	CPV-332-J1S
3	2.63	–0.002	0.281	0.185	0.025	0.156	CPV-334-J1S
3.125	2.755	–0.002	0.281	0.185	0.025	0.156	CPV-335-J1S
3.25	2.88	–0.002	0.281	0.185	0.025	0.156	CPV-336-J1S
3.5	3.13	–0.002	0.281	0.185	0.025	0.156	CPV-338-J1S
4	3.63	–0.002	0.281	0.185	0.025	0.156	CPV-342-J1S
4.5	4.13	–0.002	0.281	0.185	0.025	0.156	CPV-346-J1S
5	4.63	–0.002	0.281	0.185	0.025	0.156	CPV-350-J1S
5.502	5.028	–0.004	0.375	0.237	0.032	0.187	CPV-429-J1S
6.002	5.528	–0.004	0.375	0.237	0.032	0.187	CPV-433-J1S
6.502	6.028	–0.004	0.375	0.237	0.032	0.187	CPV-437-J1S
7.002	6.528	–0.004	0.375	0.237	0.032	0.187	CPV-439-J1S
7.252	6.778	–0.004	0.375	0.237	0.032	0.187	CPV-440-J1S
8.002	7.528	–0.004	0.375	0.237	0.032	0.187	CPV-443-J1S
9.002	8.528	–0.004	0.375	0.237	0.032	0.187	CPV-446-J1S

Other sizes are available on request

## GH profile data



<b>Materials</b>	Slide ring: PTFE 292 Energizer: NBR N70 For additional information → <b>page 26</b>
<b>Pressure</b>	Up to 400 bar (5 800 psi)
<b>Speed</b>	Up to 1 m/s (3.2 ft/s)
<b>Temperature range</b>	<p>For temperature limits depending on fluid compatibility → <b>table 8, page 32</b></p> <ul style="list-style-type: none"> <li><span style="color: blue;">■</span> Extreme low temperature range: may be intermittently exposed (e.g. cold start-up) without seal damage, but seal performance may be compromised while in this range</li> <li><span style="color: gray;">■</span> Temperatures below the recommended operating range: seal performance depends on system design (precision guiding arrangement recommended)</li> <li><span style="color: green;">■</span> <b>Recommended operating temperature range for this profile and material</b></li> <li><span style="color: yellow;">■</span> Temperatures above the recommended operating range: acceptable only with reduced pressure, speed, and/or e-gap</li> <li><span style="color: red;">■</span> Extreme high temperature range: only occasional short term exposure (e.g. cylinder in curing oven of a powder coating process)</li> </ul>
<b>Dimension standards</b>	Some metric sizes fit seal housings in accordance with ISO 7425-1.
<b>Counter-surface</b>	→ <b>page 22</b>

Maximum values of application parameters (e.g. pressure, speed, temperature, e-gap) should not be applied continuously nor simultaneously.

## 2.5 GH profile piston seals, metric sizes

D 14 – 70 mm

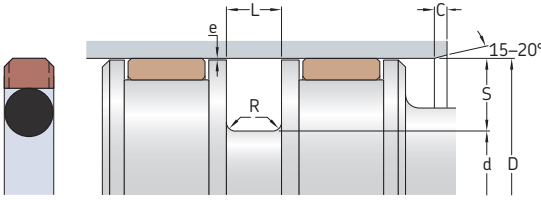

### Maximum extrusion gap e

Radial depth S	e <sub>max</sub> at 80 °C (175 °F) for pressures		
	160 bar	250 bar	400 bar
mm	mm		
2,45	0,35	0,25	0,15
3,75	0,35	0,25	0,15
5,5	0,4	0,3	0,2
7,75	0,5	0,35	0,25
10,5	0,6	0,45	0,35

2.5

### Cylinder dimensions

### Designation

D H9	d h9	L ±0,05	S	R max.	C min.	
mm						-
14	9,1	2,2	2,45	0,5	3	GH 14x9.1x2.2-AD1
18	10,5	3,2	3,75	0,5	5	GH 18x10.5x3.2-AD1
20	15,1	2,2	2,45	0,5	3	GH 20x15.1x2.2-AD1
	12,5	3,2	3,75	0,5	5	• GH 20x12.5x3.2-AD1
22	14,5	3,2	3,75	0,5	5	GH 22x14.5x3.2-AD1
25	17,5	3,2	3,75	0,5	5	• GH 25x17.5x3.2-AD1
28	20,5	3,2	3,75	0,5	5	GH 28x20.5x3.2-AD1
30	22,5	3,2	3,75	0,5	5	GH 30x22.5x3.2-AD1
32	24,5	3,2	3,75	0,5	5	• GH 32x24.5x3.2-AD1
35	27,5	3,2	3,75	0,5	5	GH 35x27.5x3.2-AD1
36	28,5	3,2	3,75	0,5	5	GH 36x28.5x3.2-AD1
40	32,5	3,2	3,75	0,5	5	• GH 40x32.5x3.2-AD1
	29	4,2	5,5	0,5	7	• GH 40x29x4.2-AD1
45	37,5	3,2	3,75	0,5	5	GH 45x37.5x3.2-AD1
	34	4,2	5,5	0,5	7	GH 45x34x4.2-AD1
50	39	4,2	5,5	0,5	7	• GH 50x39x4.2-AD1
	34,5	6,3	7,75	0,5	10	• GH 50x34.5x6.3-AD1
60	49	4,2	5,5	0,5	7	GH 60x49x4.2-AD1
63	52	4,2	5,5	0,5	7	• GH 63x52x4.2-AD1
65	54	4,2	5,5	0,9	7	GH 65x54x4.2-AD1
70	59	4,2	5,5	0,9	7	GH 70x59x4.2-AD1

• Seal housing dimensions in accordance with ISO 7425-1

## 2.5 GH profile piston seals, metric sizes

D 75 – 200 mm

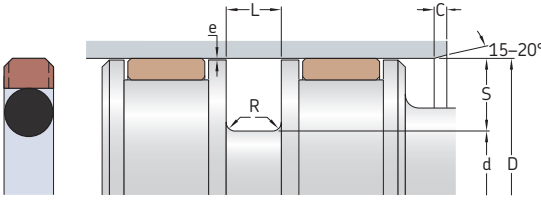

### Maximum extrusion gap e

Radial depth S	e <sub>max</sub> at 80 °C (175 °F) for pressures		
	160 bar	250 bar	400 bar
mm	mm		
2,45	0,35	0,25	0,15
3,75	0,35	0,25	0,15
5,5	0,4	0,3	0,2
7,75	0,5	0,35	0,25
10,5	0,6	0,45	0,35

### Cylinder dimensions

### Designation

D H9	d h9	L ±0,05	S	R max.	C min.	Designation
mm						-
75	64 59,5	4,2 6,3	5,5 7,75	0,9 0,9	7 10	GH 75x64x4.2-AD1 GH 75x59.5x6.3-AD1
80	69 64,5	4,2 6,3	5,5 7,75	0,9 0,9	7 10	• GH 80x69x4.2-AD1 • GH 80x64.5x6.3-AD1
85	74 69,5	4,2 6,3	5,5 7,75	0,9 0,9	7 10	GH 85x74x4.2-AD1 GH 85x69.5x6.3-AD1
90	79 74,5	4,2 6,3	5,5 7,75	0,9 0,9	7 10	GH 90x79x4.2-AD1 GH 90x74.5x6.3-AD1
95	84 79,5	4,2 6,3	5,5 7,75	0,9 0,9	7 10	GH 95x84x4.2-AD1 GH 95x79.5x6.3-AD1
100	84,5 79	6,3 8,1	7,75 10,5	0,9 0,9	10 12	• GH 100x84.5x6.3-AD1 GH 100x79x8.1-AD1
105	89,5	6,3	7,75	0,9	10	GH 105x89.5x6.3-AD1
110	94,5	6,3	7,75	0,9	10	GH 110x94.5x6.3-AD1
115	99,5	6,3	7,75	0,9	10	GH 115x99.5x6.3-AD1
120	104,5	6,3	7,75	0,9	10	GH 120x104.5x6.3-AD1
125	109,5 104	6,3 8,1	7,75 10,5	0,9 0,9	10 12	• GH 125x109.5x6.3-AD1 • GH 125x104x8.1-AD1
130	114,5 109	6,3 8,1	7,75 10,5	0,9 0,9	10 12	GH 130x114.5x6.3-AD1 GH 130x109x8.1-AD1
140	124,5 119	6,3 8,1	7,75 10,5	0,9 0,9	10 12	GH 140x124.5x6.3-AD1 GH 140x119x8.1-AD1
150	134,5 129	6,3 8,1	7,75 10,5	0,9 0,9	10 12	GH 150x134.5x6.3-AD1 GH 150x129x8.1-AD1

• Seal housing dimensions in accordance with ISO 7425-1

Cylinder dimensions						Designation
D H9	d h9	L ±0,05	S	R max.	C min.	
mm						-
160	144,5	6,3	7,75	0,9	10	• GH 160x144.5x6.3-AD1
	139	8,1	10,5	0,9	12	• GH 160x139x8.1-AD1
170	149	8,1	10,5	0,9	12	GH 170x149x8.1-AD1
180	159	8,1	10,5	0,9	12	GH 180x159x8.1-AD1
190	169	8,1	10,5	0,9	12	GH 190x169x8.1-AD1
200	179	8,1	10,5	0,9	12	• GH 200x179x8.1-AD1

Other sizes are available on request

• Seal housing dimensions in accordance with ISO 7425-1

## 2.5 GH profile piston seals, inch sizes

D 0.5 – 2.375 in.

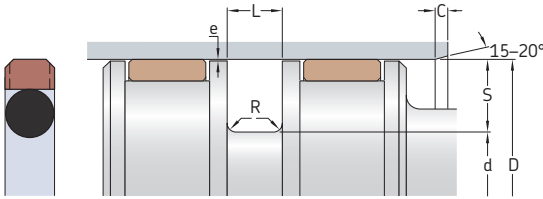

### Maximum extrusion gap e

Radial depth S	e <sub>max</sub> at 80 °C (175 °F)		
	for pressures		
	2 300 psi	3 600 psi	5 800 psi
in.	in.		
<b>0.087</b>	0.014	0.01	0.006
<b>0.13</b>	0.014	0.01	0.006
<b>0.149</b>	0.014	0.01	0.006
<b>0.196</b>	0.015	0.011	0.007
<b>0.212</b>	0.016	0.012	0.008
<b>0.259</b>	0.018	0.013	0.009
<b>0.308</b>	0.020	0.014	0.01
<b>0.415</b>	0.024	0.018	0.014

### Cylinder dimensions

### Designation

D	Tolerance	d	Tolerance	L	S	R	C	
				±0.002		max.	min.	
in.								-
0.5	+0.002	0.24	±0.002	0.083	0.13	0.015	0.1	GH0D-500-AD1
	+0.002	0.326	±0.001	0.083	0.087	0.015	0.08	GH0A-500-AD1
0.562	+0.002	0.302	±0.002	0.083	0.13	0.015	0.1	GH0D-562-AD1
	+0.002	0.388	±0.001	0.083	0.087	0.015	0.08	GH0A-562-AD1
0.625	+0.002	0.365	±0.002	0.083	0.13	0.015	0.1	GH0D-625-AD1
	+0.002	0.451	±0.001	0.083	0.087	0.015	0.08	GH0A-625-AD1
0.687	+0.002	0.389	±0.001	0.128	0.149	0.015	0.125	GH1A-687-AD1
	+0.002	0.427	±0.002	0.083	0.13	0.015	0.1	GH0D-687-AD1
	+0.002	0.513	±0.001	0.083	0.087	0.015	0.08	GH0A-687-AD1
0.75	+0.002	0.452	±0.001	0.128	0.149	0.015	0.125	GH1A-750-AD1
	+0.002	0.49	±0.002	0.083	0.13	0.015	0.1	GH0D-750-AD1
	+0.002	0.576	±0.001	0.083	0.087	0.015	0.08	GH0A-750-AD1
0.812	+0.002	0.514	±0.001	0.128	0.149	0.015	0.125	GH1A-812-AD1
	+0.002	0.552	±0.002	0.083	0.13	0.015	0.1	GH0D-812-AD1
	+0.002	0.638	±0.001	0.083	0.087	0.015	0.08	GH0A-812-AD1
0.875	+0.002	0.577	±0.001	0.128	0.149	0.015	0.125	GH1A-875-AD1
	+0.002	0.615	±0.002	0.083	0.13	0.015	0.1	GH0D-875-AD1
	+0.002	0.701	±0.001	0.083	0.087	0.015	0.08	GH0A-875-AD1
0.937	+0.002	0.639	±0.001	0.128	0.149	0.015	0.125	GH1A-937-AD1
	+0.002	0.677	±0.002	0.083	0.13	0.015	0.1	GH0D-937-AD1
	+0.002	0.763	±0.001	0.083	0.087	0.015	0.08	GH0A-937-AD1
1	+0.002	0.702	±0.001	0.128	0.149	0.015	0.125	GH1A-1000-AD1
	+0.002	0.74	±0.002	0.083	0.13	0.015	0.1	GH0D-1000-AD1
	+0.002	0.826	±0.001	0.083	0.087	0.015	0.08	GH0A-1000-AD1
1.062	+0.002	0.764	±0.001	0.128	0.149	0.015	0.125	GH1A-1062-AD1
	+0.002	0.802	±0.002	0.083	0.13	0.015	0.1	GH0D-1062-AD1
	+0.002	0.888	±0.001	0.083	0.087	0.015	0.08	GH0A-1062-AD1
1.125	+0.002	0.827	±0.001	0.128	0.149	0.015	0.125	GH1A-1125-AD1
	+0.002	0.865	±0.002	0.083	0.13	0.015	0.1	GH0D-1125-AD1
	+0.002	0.951	±0.001	0.083	0.087	0.015	0.08	GH0A-1125-AD1



Cylinder dimensions				Designation				
D		d		L	S	R	C	
	Tolerance		Tolerance	±0.002		max.	min.	
in.								-
1.187	+0.002	0.889	±0.001	0.128	0.149	0.015	0.125	GH1A-1187-AD1
	+0.002	0.927	±0.002	0.083	0.13	0.015	0.1	GH0D-1187-AD1
	+0.002	1.013	±0.001	0.083	0.087	0.015	0.08	GH0A-1187-AD1
1.25	+0.002	0.952	±0.001	0.128	0.149	0.015	0.125	GH1A-1250-AD1
	+0.002	0.99	±0.002	0.083	0.13	0.015	0.1	GH0D-1250-AD1
	+0.002	1.076	±0.001	0.083	0.087	0.015	0.08	GH0A-1250-AD1
1.312	+0.002	1.014	±0.001	0.128	0.149	0.015	0.125	GH1A-1312-AD1
	+0.002	1.052	±0.002	0.083	0.13	0.015	0.1	GH0D-1312-AD1
	+0.002	1.138	±0.001	0.083	0.087	0.015	0.08	GH0A-1312-AD1
1.375	+0.002	1.077	±0.001	0.128	0.149	0.015	0.125	GH1A-1375-AD1
	+0.002	1.115	±0.002	0.083	0.13	0.015	0.1	GH0D-1375-AD1
	+0.002	1.201	±0.001	0.083	0.087	0.015	0.08	GH0A-1375-AD1
1.437	+0.002	1.139	±0.001	0.128	0.149	0.015	0.125	GH1A-1437-AD1
	+0.002	1.177	±0.002	0.083	0.13	0.015	0.1	GH0D-1437-AD1
	+0.002	1.263	±0.001	0.083	0.087	0.015	0.08	GH0A-1437-AD1
1.5	+0.002	1.202	±0.001	0.128	0.149	0.015	0.125	GH1A-1500-AD1
	+0.002	1.24	±0.002	0.083	0.13	0.015	0.1	GH0D-1500-AD1
	+0.002	1.326	±0.001	0.083	0.087	0.015	0.08	GH0A-1500-AD1
1.562	+0.002	1.138	±0.002	0.168	0.212	0.015	0.14	GH2A-1562-AD1
	+0.002	1.17	±0.002	0.122	0.196	0.015	0.125	GH1D-1562-AD1
	+0.002	1.264	±0.001	0.128	0.149	0.015	0.125	GH1A-1562-AD1
1.625	+0.002	1.201	±0.002	0.168	0.212	0.015	0.14	GH2A-1625-AD1
	+0.002	1.233	±0.002	0.122	0.196	0.015	0.125	GH1D-1625-AD1
	+0.002	1.327	±0.001	0.128	0.149	0.015	0.125	GH1A-1625-AD1
1.687	+0.002	1.263	±0.002	0.168	0.212	0.015	0.14	GH2A-1687-AD1
	+0.002	1.295	±0.002	0.122	0.196	0.015	0.125	GH1D-1687-AD1
	+0.002	1.389	±0.001	0.128	0.149	0.015	0.125	GH1A-1687-AD1
1.75	+0.002	1.326	±0.002	0.168	0.212	0.015	0.14	GH2A-1750-AD1
	+0.002	1.358	±0.002	0.122	0.196	0.015	0.125	GH1D-1750-AD1
	+0.002	1.452	±0.001	0.128	0.149	0.015	0.125	GH1A-1750-AD1
1.812	+0.002	1.388	±0.002	0.168	0.212	0.015	0.14	GH2A-1812-AD1
	+0.002	1.42	±0.002	0.122	0.196	0.015	0.125	GH1D-1812-AD1
	+0.002	1.514	±0.001	0.128	0.149	0.015	0.125	GH1A-1812-AD1
1.875	+0.002	1.451	±0.002	0.168	0.212	0.015	0.14	GH2A-1875-AD1
	+0.002	1.483	±0.002	0.122	0.196	0.015	0.125	GH1D-1875-AD1
	+0.002	1.577	±0.001	0.128	0.149	0.015	0.125	GH1A-1875-AD1
1.937	+0.002	1.513	±0.002	0.168	0.212	0.015	0.14	GH2A-1937-AD1
	+0.002	1.545	±0.002	0.122	0.196	0.015	0.125	GH1D-1937-AD1
	+0.002	1.639	±0.001	0.128	0.149	0.015	0.125	GH1A-1937-AD1
2	+0.002	1.576	±0.002	0.168	0.212	0.015	0.14	GH2A-2000-AD1
	+0.002	1.608	±0.002	0.129	0.196	0.015	0.125	GH1D-2000-AD1
	+0.002	1.702	±0.001	0.128	0.149	0.015	0.125	GH1A-2000-AD1
2.125	+0.002	1.701	±0.002	0.168	0.212	0.015	0.14	GH2A-2125-AD1
	+0.002	1.733	±0.002	0.129	0.196	0.015	0.125	GH1D-2125-AD1
	+0.002	1.827	±0.001	0.128	0.149	0.015	0.125	GH1A-2125-AD1
2.25	+0.002	1.826	±0.002	0.168	0.212	0.015	0.14	GH2A-2250-AD1
	+0.002	1.858	±0.002	0.129	0.196	0.015	0.125	GH1D-2250-AD1
	+0.002	1.952	±0.001	0.128	0.149	0.015	0.125	GH1A-2250-AD1
2.375	+0.002	1.951	±0.002	0.168	0.212	0.015	0.14	GH2A-2375-AD1
	+0.002	1.983	±0.002	0.129	0.196	0.015	0.125	GH1D-2375-AD1
	+0.002	2.077	±0.001	0.128	0.149	0.015	0.125	GH1A-2375-AD1

## 2.5 GH profile piston seals, inch sizes

D 2.5 – 5.625 in.

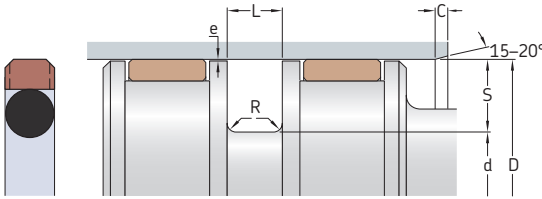

### Maximum extrusion gap e

Radial depth S	e <sub>max</sub> at 80 °C (175 °F) for pressures		
	2 300 psi	3 600 psi	5 800 psi
in.	in.		
<b>0.087</b>	0.014	0.01	0.006
<b>0.13</b>	0.014	0.01	0.006
<b>0.149</b>	0.014	0.01	0.006
<b>0.196</b>	0.015	0.011	0.007
<b>0.212</b>	0.016	0.012	0.008
<b>0.259</b>	0.018	0.013	0.009
<b>0.308</b>	0.020	0.014	0.01
<b>0.415</b>	0.024	0.018	0.014

### Cylinder dimensions

### Designation

D	Tolerance	d	Tolerance	L	S	R	C	Designation
				±0.002		max.	min.	
in.								-
2.5	+0.002	2.076	±0.002	0.168	0.212	0.015	0.14	GH2A-2500-AD1
	+0.002	2.108	±0.002	0.129	0.196	0.015	0.125	GH1D-2500-AD1
	+0.002	2.202	±0.001	0.128	0.149	0.015	0.125	GH1A-2500-AD1
2.625	+0.002	2.201	±0.002	0.168	0.212	0.015	0.14	GH2A-2625-AD1
	+0.002	2.233	±0.002	0.129	0.196	0.015	0.125	GH1D-2625-AD1
	+0.002	2.327	±0.001	0.128	0.149	0.015	0.125	GH1A-2625-AD1
2.75	+0.002	2.326	±0.002	0.168	0.212	0.015	0.14	GH2A-2750-AD1
	+0.002	2.358	±0.002	0.129	0.196	0.015	0.125	GH1D-2750-AD1
	+0.002	2.452	±0.001	0.128	0.149	0.015	0.125	GH1A-2750-AD1
2.875	+0.002	2.451	±0.002	0.168	0.212	0.015	0.14	GH2A-2875-AD1
	+0.002	2.483	±0.002	0.129	0.196	0.015	0.125	GH1D-2875-AD1
	+0.002	2.577	±0.001	0.128	0.149	0.015	0.125	GH1A-2875-AD1
3	+0.002	2.576	±0.002	0.168	0.212	0.015	0.14	GH2A-3000-AD1
	+0.002	2.608	±0.002	0.129	0.196	0.015	0.125	GH1D-3000-AD1
	+0.002	2.702	±0.001	0.128	0.149	0.015	0.125	GH1A-3000-AD1
3.125	+0.002	2.509	±0.003	0.249	0.308	0.025	0.2	GH3A-3125-AD1
	+0.002	2.701	±0.002	0.168	0.212	0.015	0.14	GH2A-3125-AD1
	+0.003	2.733	±0.002	0.129	0.196	0.015	0.125	GH1D-3125-AD1
3.25	+0.002	2.634	±0.003	0.249	0.308	0.025	0.2	GH3A-3250-AD1
	+0.002	2.826	±0.002	0.168	0.212	0.015	0.14	GH2A-3250-AD1
	+0.003	2.858	±0.002	0.129	0.196	0.015	0.125	GH1D-3250-AD1
3.375	+0.002	2.759	±0.003	0.249	0.308	0.025	0.2	GH3A-3375-AD1
	+0.002	2.951	±0.002	0.168	0.212	0.015	0.14	GH2A-3375-AD1
	+0.003	2.983	±0.002	0.129	0.196	0.015	0.125	GH1D-3375-AD1
3.5	+0.002	2.884	±0.003	0.249	0.308	0.025	0.2	GH3A-3500-AD1
	+0.002	3.076	±0.002	0.168	0.212	0.015	0.14	GH2A-3500-AD1
	+0.003	3.108	±0.002	0.129	0.196	0.015	0.125	GH1D-3500-AD1
3.625	+0.002	3.009	±0.003	0.249	0.308	0.025	0.2	GH3A-3625-AD1
	+0.002	3.201	±0.002	0.168	0.212	0.015	0.14	GH2A-3625-AD1
	+0.003	3.233	±0.002	0.129	0.196	0.015	0.125	GH1D-3625-AD1

Cylinder dimensions				Designation				
D	Tolerance	d	Tolerance	L ±0.002	S	R max.	C min.	
in.								
3.75	+0.002	3.134	±0.003	0.249	0.308	0.025	0.2	GH3A-3750-AD1
	+0.002	3.326	±0.002	0.168	0.212	0.015	0.14	GH2A-3750-AD1
	+0.003	3.358	±0.002	0.129	0.196	0.015	0.125	GH1D-3750-AD1
3.875	+0.002	3.259	±0.003	0.249	0.308	0.025	0.2	GH3A-3875-AD1
	+0.002	3.451	±0.002	0.168	0.212	0.015	0.14	GH2A-3875-AD1
	+0.003	3.483	±0.002	0.129	0.196	0.015	0.125	GH1D-3875-AD1
4	+0.002	3.384	±0.003	0.249	0.308	0.025	0.2	GH3A-4000-AD1
	+0.002	3.576	±0.002	0.168	0.212	0.015	0.14	GH2A-4000-AD1
	+0.003	3.608	±0.002	0.129	0.196	0.015	0.125	GH1D-4000-AD1
4.125	+0.002	3.509	±0.003	0.249	0.308	0.025	0.2	GH3A-4125-AD1
	+0.002	3.701	±0.002	0.168	0.212	0.015	0.14	GH2A-4125-AD1
	+0.003	3.733	±0.002	0.129	0.196	0.015	0.125	GH1D-4125-AD1
4.25	+0.002	3.634	±0.003	0.249	0.308	0.025	0.2	GH3A-4250-AD1
	+0.002	3.826	±0.002	0.168	0.212	0.015	0.14	GH2A-4250-AD1
	+0.003	3.858	±0.002	0.129	0.196	0.015	0.125	GH1D-4250-AD1
4.375	+0.002	3.759	±0.003	0.249	0.308	0.025	0.2	GH3A-4375-AD1
	+0.002	3.951	±0.002	0.168	0.212	0.015	0.14	GH2A-4375-AD1
	+0.003	3.983	±0.002	0.129	0.196	0.015	0.125	GH1D-4375-AD1
4.5	+0.002	3.884	±0.003	0.249	0.308	0.025	0.2	GH3A-4500-AD1
	+0.002	4.076	±0.002	0.168	0.212	0.015	0.14	GH2A-4500-AD1
	+0.003	4.108	±0.002	0.129	0.196	0.015	0.125	GH1D-4500-AD1
4.625	+0.002	4.009	±0.003	0.249	0.308	0.025	0.2	GH3A-4625-AD1
	+0.002	4.201	±0.002	0.168	0.212	0.015	0.14	GH2A-4625-AD1
	+0.003	4.233	±0.002	0.129	0.196	0.015	0.125	GH1D-4625-AD1
4.75	+0.002	4.134	±0.003	0.249	0.308	0.025	0.2	GH3A-4750-AD1
	+0.002	4.326	±0.002	0.168	0.212	0.015	0.14	GH2A-4750-AD1
	+0.003	4.358	±0.002	0.129	0.196	0.015	0.125	GH1D-4750-AD1
4.875	+0.002	4.259	±0.003	0.249	0.308	0.025	0.2	GH3A-4875-AD1
	+0.002	4.451	±0.002	0.168	0.212	0.015	0.14	GH2A-4875-AD1
	+0.003	4.483	±0.002	0.129	0.196	0.015	0.125	GH1D-4875-AD1
5	+0.002	4.384	±0.003	0.249	0.308	0.025	0.2	GH3A-5000-AD1
	+0.002	4.576	±0.002	0.168	0.212	0.015	0.14	GH2A-5000-AD1
	+0.003	4.608	±0.002	0.129	0.196	0.015	0.125	GH1D-5000-AD1
5.125	+0.002	4.509	±0.003	0.249	0.308	0.025	0.2	GH3A-5125-AD1
	+0.002	4.701	±0.002	0.168	0.212	0.015	0.14	GH2A-5125-AD1
	+0.003	4.733	±0.002	0.129	0.196	0.015	0.125	GH1D-5125-AD1
5.25	+0.002	4.42	±0.004	0.322	0.415	0.035	0.25	GH4A-5250-AD1
	+0.002	4.634	±0.003	0.249	0.308	0.025	0.2	GH3A-5250-AD1
	+0.003	4.826	±0.002	0.168	0.212	0.015	0.14	GH2A-5250-AD1
	+0.003	4.858	±0.002	0.129	0.196	0.015	0.125	GH1D-5250-AD1
5.375	+0.002	4.545	±0.004	0.322	0.415	0.035	0.25	GH4A-5375-AD1
	+0.002	4.759	±0.003	0.249	0.308	0.025	0.2	GH3A-5375-AD1
	+0.003	4.951	±0.002	0.168	0.212	0.015	0.14	GH2A-5375-AD1
	+0.004	4.983	±0.002	0.129	0.196	0.015	0.125	GH1D-5375-AD1
5.5	+0.002	4.67	±0.004	0.322	0.415	0.035	0.25	GH4A-5500-AD1
	+0.002	4.884	±0.003	0.249	0.308	0.025	0.2	GH3A-5500-AD1
	+0.003	5.076	±0.002	0.168	0.212	0.015	0.14	GH2A-5500-AD1
	+0.004	5.108	±0.002	0.129	0.196	0.015	0.125	GH1D-5500-AD1
5.625	+0.003	4.795	±0.004	0.322	0.415	0.035	0.25	GH4A-5625-AD1
	+0.003	5.009	±0.003	0.249	0.308	0.025	0.2	GH3A-5625-AD1
	+0.004	5.107	±0.004	0.159	0.259	0.015	0.14	GH2D-5625-AD1

2.5

## 2.5 GH profile piston seals, inch sizes

D 5.75 – 16 in.

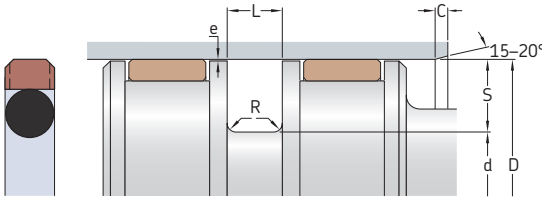

### Maximum extrusion gap e

Radial depth S	e <sub>max</sub> at 80 °C (175 °F) for pressures		
	2 300 psi	3 600 psi	5 800 psi
in.	in.		
<b>0.087</b>	0.014	0.01	0.006
<b>0.13</b>	0.014	0.01	0.006
<b>0.149</b>	0.014	0.01	0.006
<b>0.196</b>	0.015	0.011	0.007
<b>0.212</b>	0.016	0.012	0.008
<b>0.259</b>	0.018	0.013	0.009
<b>0.308</b>	0.020	0.014	0.01
<b>0.415</b>	0.024	0.018	0.014

### Cylinder dimensions

### Designation

D	Tolerance	d	Tolerance	L	S	R	C	Designation
in.				±0.002		max.	min.	-
5.75	+0.003	4.92	±0.004	0.322	0.415	0.035	0.25	GH4A-5750-AD1
	+0.003	5.134	±0.003	0.249	0.308	0.025	0.2	GH3A-5750-AD1
	+0.004	5.232	±0.004	0.159	0.259	0.015	0.14	GH2D-5750-AD1
5.875	+0.003	5.045	±0.004	0.322	0.415	0.035	0.25	GH4A-5875-AD1
	+0.003	5.259	±0.003	0.249	0.308	0.025	0.2	GH3A-5875-AD1
	+0.004	5.357	±0.004	0.159	0.259	0.015	0.14	GH2D-5875-AD1
6	+0.003	5.17	±0.004	0.322	0.415	0.035	0.25	GH4A-6000-AD1
	+0.003	5.384	±0.003	0.249	0.308	0.025	0.2	GH3A-6000-AD1
	+0.004	5.482	±0.004	0.159	0.259	0.015	0.14	GH2D-6000-AD1
6.125	+0.003	5.295	±0.004	0.322	0.415	0.035	0.25	GH4A-6125-AD1
	+0.003	5.509	±0.003	0.249	0.308	0.025	0.2	GH3A-6125-AD1
	+0.004	5.607	±0.004	0.159	0.259	0.015	0.14	GH2D-6125-AD1
6.25	+0.003	5.42	±0.004	0.322	0.415	0.035	0.25	GH4A-6250-AD1
	+0.003	5.634	±0.003	0.249	0.308	0.025	0.2	GH3A-6250-AD1
	+0.004	5.732	±0.004	0.159	0.259	0.015	0.14	GH2D-6250-AD1
6.375	+0.003	5.545	±0.004	0.322	0.415	0.035	0.25	GH4A-6375-AD1
	+0.003	5.759	±0.003	0.249	0.308	0.025	0.2	GH3A-6375-AD1
	+0.004	5.857	±0.004	0.159	0.259	0.015	0.14	GH2D-6375-AD1
6.5	+0.003	5.67	±0.004	0.322	0.415	0.035	0.25	GH4A-6500-AD1
	+0.003	5.884	±0.003	0.249	0.308	0.025	0.2	GH3A-6500-AD1
	+0.004	5.982	±0.004	0.159	0.259	0.015	0.14	GH2D-6500-AD1
6.75	+0.003	5.92	±0.004	0.322	0.415	0.035	0.25	GH4A-6750-AD1
	+0.003	6.134	±0.003	0.249	0.308	0.025	0.2	GH3A-6750-AD1
	+0.004	6.232	±0.004	0.159	0.259	0.015	0.14	GH2D-6750-AD1
7	+0.003	6.17	±0.004	0.322	0.415	0.035	0.25	GH4A-7000-AD1
	+0.003	6.384	±0.003	0.249	0.308	0.025	0.2	GH3A-7000-AD1
	+0.004	6.482	±0.004	0.159	0.259	0.015	0.14	GH2D-7000-AD1
7.25	+0.003	6.42	±0.004	0.322	0.415	0.035	0.25	GH4A-7250-AD1
	+0.003	6.634	±0.003	0.249	0.308	0.025	0.2	GH3A-7250-AD1
	+0.004	6.732	±0.004	0.159	0.259	0.015	0.14	GH2D-7250-AD1

Cylinder dimensions				Designation				
D	Tolerance	d	Tolerance	L ±0.002	S	R max.	C min.	
in.								-
7.5	+0.003	6.67	±0.004	0.322	0.415	0.035	0.25	GH4A-7500-AD1
	+0.003	6.884	±0.003	0.249	0.308	0.025	0.2	GH3A-7500-AD1
	+0.004	6.982	±0.004	0.159	0.259	0.015	0.14	GH2D-7500-AD1
7.75	+0.003	6.92	±0.004	0.322	0.415	0.035	0.25	GH4A-7750-AD1
	+0.003	7.134	±0.003	0.249	0.308	0.025	0.2	GH3A-7750-AD1
	+0.004	7.232	±0.004	0.159	0.259	0.015	0.14	GH2D-7750-AD1
8	+0.003	7.17	±0.004	0.322	0.415	0.035	0.25	GH4A-8000-AD1
	+0.003	7.384	±0.003	0.249	0.308	0.025	0.2	GH3A-8000-AD1
	+0.004	7.482	±0.004	0.159	0.259	0.015	0.14	GH2D-8000-AD1
8.25	+0.003	7.42	±0.004	0.322	0.415	0.035	0.25	GH4A-8250-AD1
	+0.003	7.634	±0.003	0.249	0.308	0.025	0.2	GH3A-8250-AD1
	+0.004	7.732	±0.004	0.159	0.259	0.015	0.14	GH2D-8250-AD1
8.5	+0.003	7.67	±0.004	0.322	0.415	0.035	0.25	GH4A-8500-AD1
	+0.003	7.884	±0.003	0.249	0.308	0.025	0.2	GH3A-8500-AD1
	+0.004	7.982	±0.004	0.159	0.259	0.015	0.14	GH2D-8500-AD1
8.75	+0.004	7.92	±0.004	0.322	0.415	0.035	0.25	GH4A-8750-AD1
9	+0.003	8.17	±0.004	0.322	0.415	0.035	0.25	GH4A-9000-AD1
	+0.003	8.384	±0.003	0.249	0.308	0.025	0.2	GH3A-9000-AD1
	+0.004	8.482	±0.004	0.159	0.259	0.015	0.14	GH2D-9000-AD1
9.5	+0.003	8.67	±0.004	0.322	0.415	0.035	0.25	GH4A-9500-AD1
	+0.003	8.884	±0.003	0.249	0.308	0.025	0.2	GH3A-9500-AD1
	+0.004	8.982	±0.004	0.159	0.259	0.015	0.14	GH2D-9500-AD1
9.75	+0.004	8.92	±0.004	0.322	0.415	0.035	0.25	GH4A-9750-AD1
10	+0.003	9.17	±0.004	0.322	0.415	0.035	0.25	GH4A-10000-AD1
	+0.003	9.384	±0.003	0.249	0.308	0.025	0.2	GH3A-10000-AD1
	+0.004	9.482	±0.004	0.159	0.259	0.015	0.14	GH2D-10000-AD1
10.5	+0.003	9.67	±0.004	0.322	0.415	0.035	0.25	GH4A-10500-AD1
	+0.003	9.884	±0.003	0.249	0.308	0.025	0.2	GH3A-10500-AD1
	+0.004	9.982	±0.004	0.159	0.259	0.015	0.14	GH2D-10500-AD1
11	+0.003	10.17	±0.004	0.322	0.415	0.035	0.25	GH4A-11000-AD1
	+0.003	10.384	±0.003	0.249	0.308	0.025	0.2	GH3A-11000-AD1
	+0.004	10.482	±0.004	0.159	0.259	0.015	0.14	GH2D-11000-AD1
11.5	+0.003	10.67	±0.004	0.322	0.415	0.035	0.25	GH4A-11500-AD1
	+0.003	10.884	±0.003	0.249	0.308	0.025	0.2	GH3A-11500-AD1
	+0.004	10.982	±0.004	0.159	0.259	0.015	0.14	GH2D-11500-AD1
12	+0.003	11.17	±0.004	0.322	0.415	0.035	0.25	GH4A-12000-AD1
	+0.003	11.384	±0.003	0.249	0.308	0.025	0.2	GH3A-12000-AD1
	+0.004	11.482	±0.004	0.159	0.259	0.015	0.14	GH2D-12000-AD1
12.5	+0.004	11.67	±0.004	0.322	0.415	0.035	0.25	GH4A-12500-AD1
13	+0.004	12.17	±0.004	0.322	0.415	0.035	0.25	GH4A-13000-AD1
13.5	+0.004	12.67	±0.004	0.322	0.415	0.035	0.25	GH4A-13500-AD1
14	+0.004	13.17	±0.004	0.322	0.415	0.035	0.25	GH4A-14000-AD1
14.5	+0.004	13.67	±0.004	0.322	0.415	0.035	0.25	GH4A-14500-AD1
15	+0.004	14.17	±0.004	0.322	0.415	0.035	0.25	GH4A-15000-AD1
15.5	+0.004	14.67	±0.004	0.322	0.415	0.035	0.25	GH4A-15500-AD1
16	+0.003	15.17	±0.004	0.322	0.415	0.035	0.25	GH4A-16000-AD1

Other sizes are available on request

## APR profile data



<b>Materials</b>	Slide ring: PTFE 741 (PTFE 702 on request) X-ring and energizer: NBR A-8501 For additional information → <b>page 26</b>
<b>Pressure</b>	Up to 350 bar (5 075 psi)
<b>Speed</b>	Up to 1 m/s (3.2 ft/s)
<b>Temperature range</b>	<p>For temperature limits depending on fluid compatibility → <b>table 8, page 32</b></p> <ul style="list-style-type: none"> <li><span style="color: blue;">■</span> Extreme low temperature range: may be intermittently exposed (e.g. cold start-up) without seal damage, but seal performance may be compromised while in this range</li> <li><span style="color: gray;">■</span> Temperatures below the recommended operating range: seal performance depends on system design (precision guiding arrangement recommended)</li> <li><span style="color: green;">■</span> <b>Recommended operating temperature range for this profile and material</b></li> <li><span style="color: yellow;">■</span> Temperatures above the recommended operating range: acceptable only with reduced pressure, speed, and/or e-gap</li> <li><span style="color: red;">■</span> Extreme high temperature range: only occasional short term exposure (e.g. cylinder in curing oven of a powder coating process)</li> </ul>
<b>Dimension standards</b>	Some metric sizes fit seal housings in accordance with ISO 7425-1.
<b>Counter-surface</b>	→ <b>page 22</b>

Maximum values of application parameters (e.g. pressure, speed, temperature, e-gap) should not be applied continuously nor simultaneously.

## 2.6 APR profile piston seals, metric sizes

### D 20 – 90 mm

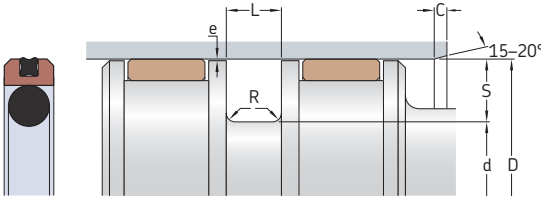

#### Maximum extrusion gap e

Radial depth S	e <sub>max</sub> at 80 °C (175 °F) for pressures		
	70 bar	200 bar	350 bar
mm	mm		
5,5	0,46	0,15	0,1
7,75	0,6	0,2	0,13
10,5	0,76	0,25	0,15

2.6

Cylinder dimensions						Designation
D	d	L	S	R	C	
H9	h9	+0,2		max.	min.	
mm						-
20	9	4,2	5,5	0,4	3	APR-20x9x4.2-AD1
22	11	4,2	5,5	0,4	3	APR-22x11x4.2-AD1
25	14	4,2	5,5	0,4	3	• APR-25x14x4.2-AD1
28	17	4,2	5,5	0,4	3	APR-28x17x4.2-AD1
30	19	4,2	5,5	0,4	3	APR-30x19x4.2-AD1
35	24	4,2	5,5	0,4	3	APR-35x24x4.2-AD1
40	29	4,2	5,5	0,4	3	• APR-40x29x4.2-AD1
42	31	4,2	5,5	0,4	3	APR-42x31x4.2-AD1
45	34	4,2	5,5	0,4	3	APR-45x34x4.2-AD1
50	39	4,2	5,5	0,4	3	• APR-50x39x4.2-AD1
55	44	4,2	5,5	0,4	3	APR-55x44x4.2-AD1
60	49	4,2	5,5	0,4	3	APR-60x49x4.2-AD1
63	52	4,2	5,5	0,4	3	• APR-63x52x4.2-AD1
65	54	4,2	5,5	0,4	3	APR-65x54x4.2-AD1
70	59	4,2	5,5	0,4	3	APR-70x59x4.2-AD1
75	64	4,2	5,5	0,4	3	APR-75x64x4.2-AD1
80	69	4,2	5,5	0,4	3	• APR-80x69x4.2-AD1
85	69,5	6,3	7,75	0,6	4	APR-85x69.5x6.3-AD1
90	74,5	6,3	7,75	0,6	4	APR-90x74.5x6.3-AD1

• Seal housing dimensions in accordance with ISO 7425-1

## 2.6 APR profile piston seals, metric sizes

D 95 – 190 mm

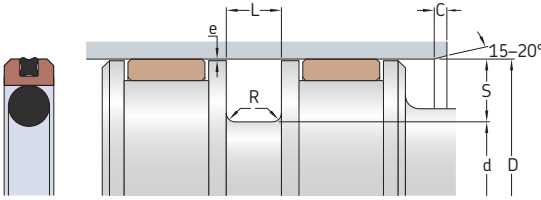

### Maximum extrusion gap e

Radial depth S	e <sub>max</sub> at 80 °C (175 °F) for pressures		
	70 bar	200 bar	350 bar
mm	mm		
5,5	0,46	0,15	0,1
7,75	0,6	0,2	0,13
10,5	0,76	0,25	0,15

### Cylinder dimensions

### Designation

D H9	d h9	L +0,2	S	R max.	C min.	Designation
mm						-
95	79,5	6,3	7,75	0,6	4	APR-95x79.5x6.3-AD1
100	84,5	6,3	7,75	0,6	4	• APR-100x84.5x6.3-AD1
105	89,5	6,3	7,75	0,6	4	APR-105x89.5x6.3-AD1
110	94,5	6,3	7,75	0,6	4	APR-110x94.5x6.3-AD1
115	99,5	6,3	7,75	0,6	4	APR-115x99.5x6.3-AD1
120	104,5	6,3	7,75	0,6	4	APR-120x104.5x6.3-AD1
125	109,5	6,3	7,75	0,6	4	• APR-125x109.5x6.3-AD1
130	114,5	6,3	7,75	0,6	4	APR-130x114.5x6.3-AD1
132	116,5	6,3	7,75	0,6	4	APR-132x116.5x6.3-AD1
135	119,5	6,3	7,75	0,6	4	APR-135x119.5x6.3-AD1
140	124,5	6,3	7,75	0,6	4	APR-140x124.5x6.3-AD1
145	129,5	6,3	7,75	0,6	4	APR-145x129.5x6.3-AD1
150	134,5	6,3	7,75	0,6	4	APR-150x134.5x6.3-AD1
155	139,5	6,3	7,75	0,6	4	APR-155x139.5x6.3-AD1
160	139	8,1	10,5	0,75	4	• APR-160x139x8.1-AD1
165	144	8,1	10,5	0,75	4	APR-165x144x8.1-AD1
170	149	8,1	10,5	0,75	4	APR-170x149x8.1-AD1
175	154	8,1	10,5	0,75	4	APR-175x154x8.1-AD1
180	159	8,1	10,5	0,75	4	APR-180x159x8.1-AD1
190	169	8,1	10,5	0,75	4	APR-190x169x8.1-AD1

Other sizes are available on request

• Seal housing dimensions in accordance with ISO 7425-1



## 2.6 APR profile piston seals, inch sizes

D 1 – 6 in.

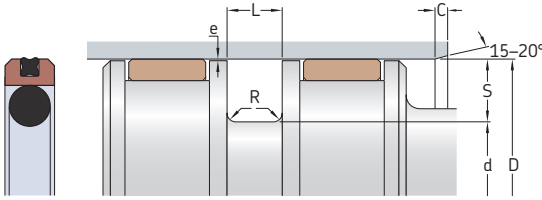

### Maximum extrusion gap e

Radial depth  $e_{max}$  at 80 °C (175 °F)  
S for pressures  
1 000 psi 3 000 psi 5 075 psi

Radial depth S	$e_{max}$ at 80 °C (175 °F)		
	1 000 psi	3 000 psi	5 075 psi
in.	in.		
0.212	0.018	0.006	0.004
0.308	0.024	0.008	0.005
0.42	0.03	0.01	0.006
0.46	0.03	0.01	0.006

### Cylinder dimensions

### Designation

D	Tolerance	d	Tolerance	L	S	R	C	Designation
				+0.005		max.	min.	
in.								-
1	+0.003	0.576	-0.003	0.21	0.212	0.015	0.156	APR2-1000-AD1
1.25	+0.003	0.826	-0.003	0.21	0.212	0.015	0.156	APR2-1250-AD1
1.5	+0.003	1.076	-0.003	0.21	0.212	0.015	0.156	APR2-1500-AD1
1.75	+0.003	1.326	-0.003	0.21	0.212	0.015	0.156	APR2-1750-AD1
2	+0.003	1.576	-0.003	0.21	0.212	0.015	0.156	APR2-2000-AD1
2.25	+0.004	1.634	-0.004	0.288	0.308	0.025	0.187	APR3-2250-AD1
2.5	+0.004	1.884	-0.004	0.288	0.308	0.025	0.187	APR3-2500-AD1
2.75	+0.004	2.134	-0.004	0.288	0.308	0.025	0.187	APR3-2750-AD1
3	+0.004	2.384	-0.004	0.288	0.308	0.025	0.187	APR3-3000-AD1
3.25	+0.004	2.634	-0.004	0.288	0.308	0.025	0.187	APR3-3250-AD1
3.5	+0.004	2.884	-0.004	0.288	0.308	0.025	0.187	APR3-3500-AD1
3.75	+0.004	3.134	-0.004	0.288	0.308	0.025	0.187	APR3-3750-AD1
4	+0.004	3.384	-0.004	0.288	0.308	0.025	0.187	APR3-4000-AD1
4.25	+0.004	3.634	-0.004	0.288	0.308	0.025	0.187	APR3-4250-AD1
4.5	+0.004	3.884	-0.004	0.288	0.308	0.025	0.187	APR3-4500-AD1
4.75	+0.004	4.134	-0.004	0.288	0.308	0.025	0.187	APR3-4750-AD1
5	+0.004	4.384	-0.004	0.288	0.308	0.025	0.187	APR3-5000-AD1
5.25	+0.004	4.634	-0.004	0.288	0.308	0.025	0.187	APR3-5250-AD1
5.5	+0.005	4.66	-0.005	0.375	0.42	0.035	0.25	APR4-5500-AD1
5.75	+0.005	4.91	-0.005	0.375	0.42	0.035	0.25	APR4-5750-AD1
6	+0.005	5.16	-0.005	0.375	0.42	0.035	0.25	APR4-6000-AD1

## 2.6 APR profile piston seals, inch sizes

### D 6.25 – 14 in.

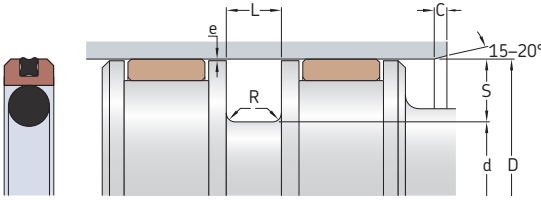

#### Maximum extrusion gap e

Radial depth  
S  
in.

$e_{max}$  at 80 °C (175 °F)  
for pressures  
1 000 psi 3 000 psi 5 075 psi

	$e_{max}$ at 80 °C (175 °F) for pressures		
	1 000 psi	3 000 psi	5 075 psi
0.212	0.018	0.006	0.004
0.308	0.024	0.008	0.005
0.42	0.03	0.01	0.006
0.46	0.03	0.01	0.006

#### Cylinder dimensions

#### Designation

D	Tolerance	d	Tolerance	L	S	R	C	Designation
in.				+0.005		max.	min.	
6.25	+0.005	5.41	-0.005	0.375	0.42	0.035	0.25	APR4-6250-AD1
6.5	+0.005	5.66	-0.005	0.375	0.42	0.035	0.25	APR4-6500-AD1
6.75	+0.005	5.91	-0.005	0.375	0.42	0.035	0.25	APR4-6750-AD1
7	+0.005	6.16	-0.005	0.375	0.42	0.035	0.25	APR4-7000-AD1
7.25	+0.005	6.41	-0.005	0.375	0.42	0.035	0.25	APR4-7250-AD1
7.5	+0.005	6.66	-0.005	0.375	0.42	0.035	0.25	APR4-7500-AD1
7.75	+0.005	6.91	-0.005	0.375	0.42	0.035	0.25	APR4-7750-AD1
8	+0.006	7.16	-0.006	0.375	0.42	0.035	0.25	APR4-8000-AD1
8.5	+0.006	7.66	-0.006	0.375	0.42	0.035	0.25	APR4-8500-AD1
9	+0.006	8.16	-0.006	0.375	0.42	0.035	0.25	APR4-9000-AD1
9.5	+0.006	8.66	-0.006	0.375	0.42	0.035	0.25	APR4-9500-AD1
10	+0.006	9.16	-0.006	0.375	0.42	0.035	0.25	APR4-10000-AD1
10.5	+0.008	9.58	-0.008	0.375	0.46	0.035	0.25	APR5-10500-AD1
11	+0.008	10.08	-0.008	0.375	0.46	0.035	0.25	APR5-11000-AD1
11.5	+0.008	10.58	-0.008	0.375	0.46	0.035	0.25	APR5-11500-AD1
12	+0.008	11.08	-0.008	0.375	0.46	0.035	0.25	APR5-12000-AD1
12.5	+0.008	11.58	-0.008	0.375	0.46	0.035	0.25	APR5-12500-AD1
13	+0.008	12.08	-0.008	0.375	0.46	0.035	0.25	APR5-13000-AD1
13.5	+0.008	12.58	-0.008	0.375	0.46	0.035	0.25	APR5-13500-AD1
14	+0.008	13.08	-0.008	0.375	0.46	0.035	0.25	APR5-14000-AD1

Other sizes are available on request



## LCP profile data



<b>Materials</b>	Slide ring: PTFE 741 (PTFE 702 on request) Energizer: NBR A-8501 Anti-extrusion rings: PA P-2506 For additional information → <b>page 26</b>
<b>Pressure</b>	Up to 690 bar (10 000 psi)
<b>Speed</b>	Up to 1,5 m/s (4.9 ft/s)
<b>Temperature range</b>	<div style="display: flex; align-items: center;"> </div> <p>For temperature limits depending on fluid compatibility → <b>table 8, page 32</b></p> <ul style="list-style-type: none"> <li><span style="color: blue;">■</span> Extreme low temperature range: may be intermittently exposed (e.g. cold start-up) without seal damage, but seal performance may be compromised while in this range</li> <li><span style="color: gray;">■</span> Temperatures below the recommended operating range: seal performance depends on system design (precision guiding arrangement recommended)</li> <li><span style="color: green;">■</span> <b>Recommended operating temperature range for this profile and material</b></li> <li><span style="color: yellow;">■</span> Temperatures above the recommended operating range: acceptable only with reduced pressure and/or speed</li> <li><span style="color: red;">■</span> Extreme high temperature range: only occasional short term exposure</li> </ul>
<b>Dimension standards</b>	Some metric sizes fit seal housings in accordance with ISO 5597.
<b>Counter-surface</b>	→ <b>page 22</b>

Maximum values of application parameters (e.g. pressure, speed, temperature, e-gap) should not be applied continuously nor simultaneously.

## 2.7 LCP profile piston seals, metric sizes

D 25 – 200 mm

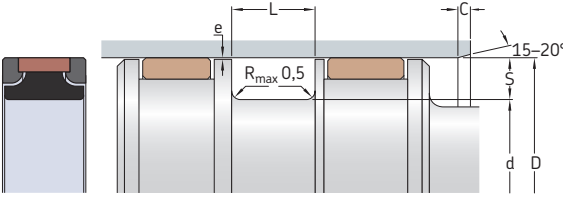

### Maximum extrusion gap e

Radial depth S  $e_{max}$  at 80 °C (175 °F) for pressures 160 bar 250 bar 400 bar 690 bar

mm	mm			
5	0,7	0,45	0,25	0,15
7,5	1	0,65	0,4	0,2
10	1,4	0,9	0,55	0,25

### Cylinder dimensions

### Designation

D H9	d h9	L +0,2	S	C min.	
mm					-
25	15	8	5	4	• LCP-25x15x8-ND1
32	22	8	5	4	• LCP-32x22x8-ND1
40	30	8	5	4	• LCP-40x30x8-ND1
50	40	8	5	4	• LCP-50x40x8-ND1
60	50	8	5	4	LCP-60x50x8-ND1
80	65	12,5	7,5	5	• LCP-80x65x12.5-ND1
90	75	12,5	7,5	5	LCP-90x75x12.5-ND1
100	85	12,5	7,5	5	• LCP-100x85x12.5-ND1
110	95	12,5	7,5	5	LCP-110x95x12.5-ND1
	97,7	14,7	6,15	5	LCP-110x97.7x14.7-ND1
120	105	12,5	7,5	6,5	LCP-120x105x12.5-ND1
125	110	12,5	7,5	6,5	LCP-125x110x12.5-ND1
140	121,5	19	9,25	6,5	LCP-140x121.5x19-ND1
	125	12,5	7,5	6,5	LCP-140x125x12.5-ND1
150	135	12,5	7,5	6,5	LCP-150x135x12.5-ND1
160	141,5	19	9,25	6,5	LCP-160x141.5x19-ND1
	145	12,5	7,5	6,5	LCP-160x145x12.5-ND1
170	155	12,5	7,5	6,5	LCP-170x155x12.5-ND1
180	165	12,5	7,5	6,5	LCP-180x165x12.5-ND1
200	180	16	10	6,5	LCP-200x180x16-ND1
	181,5	19	9,25	6,5	LCP-200x181.5x19-ND1

• Seal housing dimensions in accordance with ISO 5597

## 2.7 LCP profile piston seals, metric sizes

D 250 – 290 mm

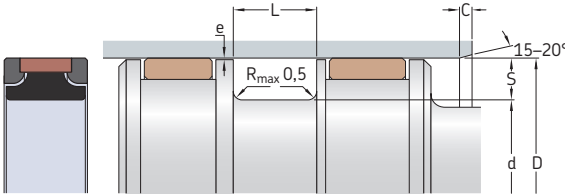

### Maximum extrusion gap e

Radial depth  $e_{\max}$  at 80 °C (175 °F)  
 S for pressures 160 bar 250 bar 400 bar 690 bar

mm	mm			
5	0,7	0,45	0,25	0,15
7,5	1	0,65	0,4	0,2
10	1,4	0,9	0,55	0,25

### Cylinder dimensions

D H9      d h9      L +0,2      S      C min.

mm

### Designation

250	230	16	10	6,5	LCP-250x230x16-ND1
290	270	16	10	7,5	LCP-290x270x16-ND1

Other sizes are available on request

## 2.7 LCP profile piston seals, inch sizes

D 3 – 16 in.

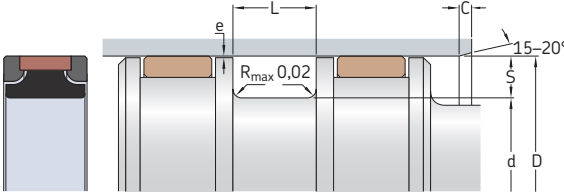

### Maximum extrusion gap e

Radial depth	Series	e <sub>max</sub> at 80 °C (175 °F) for pressures			
		2 300 psi	3 600 psi	5 800 psi	10 000 psi
S					
in.		in.			
<b>0.187</b>	3	0.026	0.017	0.01	0.006
<b>0.24</b>	4	0.04	0.025	0.016	0.009
<b>0.365</b>	6	0.053	0.034	0.021	0.012
<b>0.42</b>	8	0.067	0.043	0.027	0.015

2.7

### Cylinder dimensions

### Designation

D	Tolerance	d	Tolerance	L	S	C	min.	
in.				+0.005				-
3	+0.003	2.52	-0.003	0.579	0.24	0.2		<b>LCP4-3000-ND1</b>
4	+0.003	3.52	-0.003	0.579	0.24	0.2		<b>LCP4-4000-ND1</b>
4.5	+0.003	4.02	-0.003	0.579	0.24	0.2		<b>LCP4-4500-ND1</b>
5	+0.004	4.27	-0.004	0.75	0.365	0.25		<b>LCP6-5000-ND1</b>
5.5	+0.004	4.77	-0.004	0.75	0.365	0.25		<b>LCP6-5500-ND1</b>
6	+0.004	5.27	-0.004	0.75	0.365	0.25		<b>LCP6-6000-ND1</b>
7	+0.004	6.27	-0.004	0.75	0.365	0.25		<b>LCP6-7000-ND1</b>
8	+0.004	7.27	-0.004	0.75	0.365	0.25		<b>LCP6-8000-ND1</b>
9	+0.004	8.27	-0.004	0.75	0.365	0.25		<b>LCP6-9000-ND1</b>
10	+0.004	9.27	-0.004	0.75	0.365	0.25		<b>LCP6-10000-ND1</b>
13	+0.004	12.27	-0.004	0.75	0.365	0.25		<b>LCP6-13000-ND1</b>
14	+0.004	13.27	-0.004	0.75	0.365	0.25		<b>LCP6-14000-ND1</b>
16	+0.004	15.27	-0.004	0.75	0.365	0.25		<b>LCP6-16000-ND1</b>

Other sizes are available on request

## LTP profile data



<b>Materials</b>	Sealing ring: NBR A-8501 Anti-extrusion rings: PA P-2506 For additional information → <b>page 26</b>
<b>Pressure</b>	Up to 345 bar (5 000 psi)
<b>Speed</b>	Pressure ≤ 250 bar (3 625 psi) → up to 1 m/s (3.2 ft/s) Pressure ≤ 350 bar (5 075 psi) → up to 0,5 m/s (1.6 ft/s)
<b>Temperature range</b>	<p>For temperature limits depending on fluid compatibility → <b>table 8, page 32</b></p> <ul style="list-style-type: none"> <li><span style="color: blue;">■</span> Extreme low temperature range: may be intermittently exposed (e.g. cold start-up) without seal damage, but seal performance may be compromised while in this range</li> <li><span style="color: grey;">■</span> Temperatures below the recommended operating range: seal performance depends on system design (precision guiding arrangement recommended)</li> <li><span style="color: green;">■</span> <b>Recommended operating temperature range for this profile and material</b></li> <li><span style="color: yellow;">■</span> Temperatures above the recommended operating range: acceptable only with reduced pressure, speed, and/or e-gap</li> <li><span style="color: red;">■</span> Extreme high temperature range: only occasional short term exposure (e.g. cylinder in curing oven of a powder coating process)</li> </ul>
<b>Counter-surface</b>	→ <b>page 22</b>

Maximum values of application parameters (e.g. pressure, speed, temperature, e-gap) should not be applied continuously nor simultaneously.



## 2.8 LTP profile piston seals, inch sizes

D 0.625 – 2.875 in.

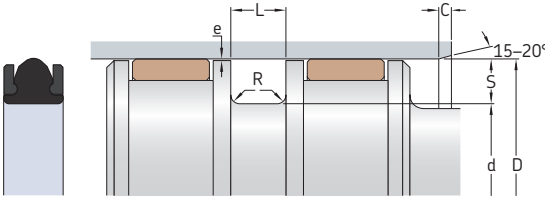

### Maximum extrusion gap e

Radial depth  $e_{max}$  at 80 °C (175 °F)  
for pressures  
1 000 psi 3 000 psi 5 000 psi

Radial depth S in.	$e_{max}$ at 80 °C (175 °F) for pressures 1 000 psi 3 000 psi 5 000 psi		
0.125	0.025	0.008	0.005
0.187	0.03	0.012	0.007
0.25	0.035	0.017	0.01

2.8

### Cylinder dimensions

### Designation

D +0.002 in.	d Tolerance	L +0.005	S	R max.	C min.	Designation
0.625	0.383 -0.002	0.187	0.125	0.02	0.125	LTP-204-E3R
0.75	0.508 -0.002	0.187	0.125	0.02	0.125	LTP-206-E3R
0.875	0.633 -0.002	0.187	0.125	0.02	0.125	LTP-208-E3R
0.937	0.695 -0.002	0.187	0.125	0.02	0.125	LTP-209-E3R
1	0.758 -0.002	0.187	0.125	0.02	0.125	LTP-210-E3R
1.062	0.82 -0.002	0.187	0.125	0.02	0.125	LTP-211-E3R
1.125	0.883 -0.002	0.187	0.125	0.02	0.125	LTP-212-E3R
1.25	1.008 -0.002	0.187	0.125	0.02	0.125	LTP-214-E3R
1.375	1.133 -0.002	0.187	0.125	0.02	0.125	LTP-216-E3R
1.5	1.258 -0.002	0.187	0.125	0.02	0.125	LTP-218-E3R
1.625	1.383 -0.002	0.187	0.125	0.02	0.125	LTP-220-E3R
1.75	1.508 -0.002	0.187	0.125	0.02	0.125	LTP-222-E3R
1.875	1.505 -0.002	0.281	0.187	0.025	0.125	LTP-325-E3R
2	1.63 -0.002	0.281	0.187	0.025	0.125	LTP-326-E3R
2.125	1.755 -0.002	0.281	0.187	0.025	0.125	LTP-327-E3R
2.25	1.88 -0.002	0.281	0.187	0.025	0.125	LTP-328-E3R
2.375	2.005 -0.002	0.281	0.187	0.025	0.125	LTP-329-E3R
2.5	2.13 -0.002	0.281	0.187	0.025	0.125	LTP-330-E3R
2.625	2.255 -0.002	0.281	0.187	0.025	0.125	LTP-331-E3R
2.75	2.38 -0.002	0.281	0.187	0.025	0.125	LTP-332-E3R
2.875	2.505 -0.002	0.281	0.187	0.025	0.125	LTP-333-E3R

## 2.8 LTP profile piston seals, inch sizes

D 3 – 12.002 in.

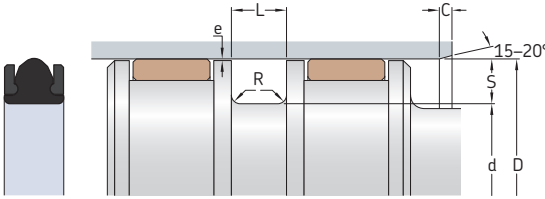

### Maximum extrusion gap e

Radial depth S	e <sub>max</sub> at 80 °C (175 °F) for pressures		
	1 000 psi	3 000 psi	5 000 psi
in.	in.		
0.125	0.025	0.008	0.005
0.187	0.03	0.012	0.007
0.25	0.035	0.017	0.01

### Cylinder dimensions

### Designation

D +0.002	d	Tolerance	L +0.005	S	R max.	C min.	Designation
in.							-
3	2.63	-0.002	0.281	0.187	0.025	0.125	LTP-334-E3R
3.125	2.755	-0.002	0.281	0.187	0.025	0.125	LTP-335-E3R
3.25	2.88	-0.002	0.281	0.187	0.025	0.125	LTP-336-E3R
3.5	3.13	-0.002	0.281	0.187	0.025	0.125	LTP-338-E3R
3.75	3.38	-0.002	0.281	0.187	0.025	0.125	LTP-340-E3R
3.875	3.505	-0.002	0.281	0.187	0.025	0.125	LTP-341-E3R
4	3.63	-0.002	0.281	0.187	0.025	0.125	LTP-342-E3R
4.125	3.755	-0.002	0.281	0.187	0.025	0.125	LTP-343-E3R
4.25	3.88	-0.002	0.281	0.187	0.025	0.125	LTP-344-E3R
4.5	4.13	-0.002	0.281	0.187	0.025	0.125	LTP-346-E3R
4.75	4.38	-0.002	0.281	0.187	0.025	0.125	LTP-348-E3R
4.875	4.505	-0.002	0.281	0.187	0.025	0.125	LTP-349-E3R
5	4.63	-0.002	0.281	0.187	0.025	0.125	LTP-350-E3R
5.252	4.778	-0.004	0.375	0.25	0.032	0.187	LTP-427-E3R
5.377	4.903	-0.004	0.375	0.25	0.032	0.187	LTP-428-E3R
5.502	5.028	-0.004	0.375	0.25	0.032	0.187	LTP-429-E3R
5.627	5.153	-0.004	0.375	0.25	0.032	0.187	LTP-430-E3R
5.752	5.278	-0.004	0.375	0.25	0.032	0.187	LTP-431-E3R
6.002	5.528	-0.004	0.375	0.25	0.032	0.187	LTP-433-E3R
6.377	6.028	-0.004	0.375	0.25	0.032	0.187	LTP-437-E3R
7.002	6.528	-0.004	0.375	0.25	0.032	0.187	LTP-439-E3R

Cylinder dimensions							Designation
D +0.002	d	Tolerance	L +0.005	S	R max.	C min.	
in.							-
<b>7.752</b>	7.278	-0.004	0.375	0.25	0.032	0.187	<b>LTP-442-E3R</b>
<b>9.502</b>	9.028	-0.004	0.375	0.25	0.032	0.187	<b>LTP-447-E3R</b>
<b>10.002</b>	9.528	-0.004	0.375	0.25	0.032	0.187	<b>LTP-448-E3R</b>
<b>12.002</b>	11.528	-0.004	0.375	0.25	0.032	0.187	<b>LTP-452-E3R</b>

Other sizes are available on request

### CUT profile data



<b>Materials</b>	Slide ring: PA66/6011 Energizer: NBR N70/6015 For additional information → <a href="#">page 26</a>
<b>Pressure</b>	Up to 500 bar (7 250 psi)
<b>Speed</b>	Up to 1 m/s (3.2 ft/s)
<b>Temperature range</b>	<p>For temperature limits depending on fluid compatibility → <a href="#">table 8, page 32</a></p> <ul style="list-style-type: none"> <li><span style="color: blue;">■</span> Extreme low temperature range: may be intermittently exposed (e.g. cold start-up) without seal damage, but seal performance may be compromised while in this range</li> <li><span style="color: gray;">■</span> Temperatures below the recommended operating range: seal performance depends on system design (precision guiding arrangement recommended)</li> <li><span style="color: green;">■</span> <b>Recommended operating temperature range for this profile and material</b></li> <li><span style="color: yellow;">■</span> Temperatures above the recommended operating range: acceptable only with reduced pressure and/or speed</li> <li><span style="color: red;">■</span> Extreme high temperature range: only occasional short term exposure</li> </ul>
<b>Dimension standards</b>	Some sizes fit seal housings in accordance with ISO 7425-1.
<b>Counter-surface</b>	→ <a href="#">page 22</a>

Maximum values of application parameters (e.g. pressure, speed, temperature, e-gap) should not be applied continuously nor simultaneously.

## 2.9 CUT profile piston seals, metric sizes

D 40 – 140 mm

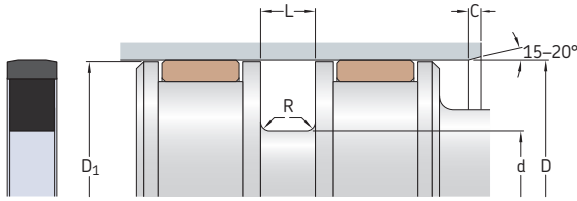

2.9

Cylinder dimensions						Designation
D H9	d h9	L +0,2	D <sub>1</sub>	R max.	C min.	
mm						-
40	29	4,2	39,2	0,3	7	• CUT 40x29x4.2
50	34,5 39	6,3 4,2	49 49,2	0,5 0,3	10 7	• CUT 50x34.5x6.3 • CUT 50x39x4.2
60	41,7	7,0	59	0,5	10	CUT 60x41.7x7.0
63	44,7 47,5	7,0 6,3	62 62	0,5 0,5	10 10	CUT 63x44.7x7 • CUT 63x47.5x6.3
65	49,5	6,3	64	0,5	10	CUT 65x49.5x6.3
70	51,7	7,0	69	0,5	10	CUT 70x51.7x7
75	54 59,5	8,1 6,3	73,8 74	0,9 0,5	12 10	CUT 75x54x8.1 CUT 75x59.5x6.3
80	59 64,5	8,1 6,3	78,8 79	0,9 0,5	12 10	CUT 80x59x8.1 • CUT 80x64.5x6.3
90	69 74,5	8,1 6,3	88,8 89	0,9 0,5	12 10	CUT 90x69x8.1 CUT 90x74.5x6.3
100	79 84,5	8,1 6,3	98,8 99	0,9 0,5	12 10	CUT 100x79x8.1 • CUT 100x84.5x6.3
110	89	8,1	108,8	0,9	12	CUT 110x89x8.1
115	94	8,1	113,8	0,9	12	CUT 115x94x8.1
120	99	8,1	118,8	0,9	12	CUT 120x99x8.1
125	104 109,5	8,1 6,3	123,8 124	0,9 0,5	12 10	• CUT 125x104x8.1 • CUT 125x109.5x6.3
130	109	8,1	128,8	0,9	12	CUT 130x109x8.1
140	119	8,1	138,8	0,9	12	CUT 140x119x8.1

• Seal housing dimensions in accordance with ISO 7425-1

## 2.9 CUT profile piston seals, metric sizes

D 150 – 320 mm

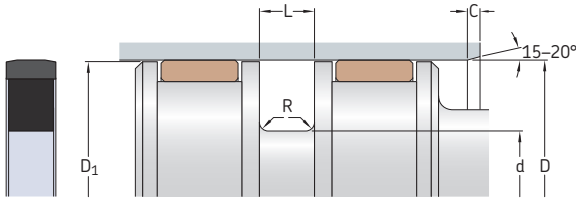

Cylinder dimensions						Designation
D H9	d h9	L +0,2	D <sub>1</sub>	R max.	C min.	
mm						-
150	129	8,1	148,8	0,9	12	CUT 150x129x8.1
160	139	8,1	158,8	0,9	12	• CUT 160x139x8.1
170	149	8,1	168,8	0,9	12	CUT 170x149x8.1
180	159	8,1	178,8	0,9	12	CUT 180x159x8.1
190	169	8,1	188,8	0,9	12	CUT 190x169x8.1
200	179	8,1	198,8	0,9	12	• CUT 200x179x8.1
210	189	8,1	198,8	0,9	12	CUT 210x189x8.1
220	199	8,1	218,8	0,9	12	CUT 220x199x8.1
230	209	8,1	228,8	0,9	12	CUT 230x209x8.1
240	219	8,1	238,8	0,9	12	CUT 240x219x8.1
	225	8,1	239	0,9	12	CUT 240x225x8.1
250	229	8,1	248,8	0,9	12	• CUT 250x229x8.1
260	239	8,1	258,8	0,9	12	CUT 260x239x8.1
280	255,5	8,1	278,8	0,9	12	CUT 280x255.5x8.1
320	292	9,5	318,4	0,9	15	CUT 320x292x9.5

Other sizes are available on request

• Seal housing dimensions in accordance with ISO 7425-1



## SCP profile data



<b>Materials</b>	Slide ring: PA P-2501 or P-2551 (depending on size) Energizer: NBR A-8526 For additional information → <b>page 26</b>
<b>Pressure</b>	Up to 690 bar (10 000 psi)
<b>Speed</b>	Up to 1 m/s (3.2 ft/s)
<b>Temperature range</b>	<p>For temperature limits depending on fluid compatibility → <b>table 8, page 32</b></p> <ul style="list-style-type: none"> <li><span style="color: blue;">■</span> Extreme low temperature range: may be intermittently exposed (e.g. cold start-up) without seal damage, but seal performance may be compromised while in this range</li> <li><span style="color: grey;">■</span> Temperatures below the recommended operating range: seal performance depends on system design (precision guiding arrangement recommended)</li> <li><span style="color: green;">■</span> <b>Recommended operating temperature range for this profile and material</b></li> <li><span style="color: yellow;">■</span> Temperatures above the recommended operating range: acceptable only with reduced pressure and/or speed</li> <li><span style="color: red;">■</span> Extreme high temperature range: only occasional short term exposure</li> </ul>
<b>Counter-surface</b>	→ <b>page 22</b>

Maximum values of application parameters (e.g. pressure, speed, temperature, e-gap) should not be applied continuously nor simultaneously.



## 2.10 SCP profile piston seals, inch sizes

### D 2 – 5.025 in.

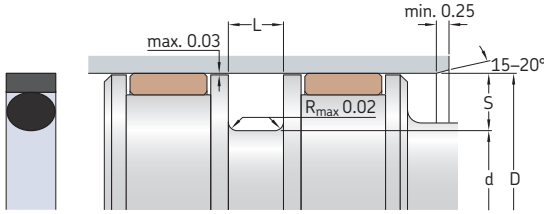

2.10

Cylinder dimensions					Designation	
D	Tolerance	d	Tolerance	L +0.002	S	
in.						-
2	+0.002	1.462	-0.002	0.282	0.269	SCP1-2000-E5E
2.25	+0.002	1.712	-0.002	0.282	0.269	SCP1-2250-E5E
2.5	+0.003	1.908	-0.002	0.312	0.296	SCP5-2500-E5E
	+0.003	1.962	-0.002	0.282	0.269	SCP1-2500-E5E
2.75	+0.003	2.212	-0.002	0.282	0.269	SCP1-2750-E5D
3	+0.003	2.408	-0.002	0.312	0.296	SCP5-3000-E5E
	+0.003	2.442	-0.003	0.282	0.279	SCP2-3000-E5E
3.25	+0.003	2.692	-0.003	0.282	0.279	SCP2-3250-E5E
3.5	+0.003	2.908	-0.003	0.312	0.296	SCP5-3500-E5E
	+0.003	2.942	-0.003	0.282	0.279	SCP2-3500-E5E
3.75	+0.003	3.192	-0.003	0.282	0.279	SCP2-3750-E5D
4	+0.003	3.408	-0.003	0.312	0.296	SCP5-4000-E5E
	+0.003	3.442	-0.003	0.282	0.279	SCP2-4000-E5E
4.025	+0.003	3.467	-0.003	0.282	0.279	SCP2-4025-E5D
4.25	+0.003	3.692	-0.003	0.282	0.279	SCP2-4250-E5D
4.265	+0.003	3.707	-0.003	0.282	0.279	SCP2-4265-E5D
4.5	+0.003	3.74	-0.003	0.377	0.38	SCP3-4500-E5D
	+0.003	3.908	-0.003	0.312	0.296	SCP5-4500-E5E
	+0.003	3.942	-0.003	0.282	0.279	SCP2-4500-E5E
4.525	+0.003	3.967	-0.003	0.282	0.279	SCP2-4525-E5D
4.75	+0.003	3.99	-0.004	0.377	0.38	SCP3-4750-E5D
	+0.003	4.192	-0.004	0.282	0.279	SCP2-4750-E5E
5	+0.004	4.24	-0.004	0.377	0.38	SCP3-5000-E5E
	+0.004	4.442	-0.004	0.282	0.279	SCP2-5000-E5E
5.025	+0.004	4.265	-0.004	0.377	0.38	SCP3-5025-E5D

## 2.10 SCP profile piston seals, inch sizes

D 5.25 – 12 in.

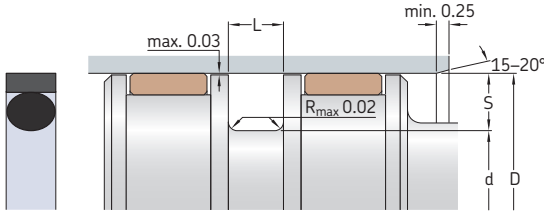

Cylinder dimensions						Designation
D	Tolerance	d	Tolerance	L +0.002	S	
in.						-
5.25	+0.004	4.49	-0.004	0.377	0.38	SCP3-5250-E5D
5.5	+0.004	4.74	-0.004	0.377	0.38	SCP3-5500-E5E
5.75	+0.004	4.99	-0.004	0.377	0.38	SCP3-5750-E5D
6	+0.004	5.24	-0.004	0.377	0.38	SCP3-6000-E5E
6.025	+0.004	5.265	-0.004	0.377	0.38	SCP3-6025-E5D
6.5	+0.004	5.74	-0.004	0.377	0.38	SCP3-6500-E5D
7	+0.004	6.24	-0.004	0.377	0.38	SCP3-7000-E5E
7.025	+0.004	6.265	-0.004	0.377	0.38	SCP3-7025-E5D
7.5	+0.004	6.74	-0.004	0.377	0.38	SCP3-7500-E5D
8	+0.004	7.24	-0.004	0.377	0.38	SCP3-8000-E5D
8.5	+0.004	7.74	-0.004	0.377	0.38	SCP3-8500-E5D
9	+0.004	8.124	-0.004	0.377	0.438	SCP4-9000-E5D
9.5	+0.004	8.624	-0.004	0.377	0.438	SCP4-9500-E5D
10	+0.004	9.124	-0.004	0.377	0.438	SCP4-10000-E5D
12	+0.004	11.124	-0.004	0.377	0.438	SCP4-12000-E5D

Other sizes are available on request



## MD-L profile data



<b>Materials</b>	Sealing ring: NBR N70 Guide rings: POM/076 Support rings: TPC ET72/075 For additional information → <b>page 26</b>
<b>Pressure</b>	Up to 250 bar (3 625 psi)
<b>Speed</b>	Up to 1 m/s (3.2 ft/s)
<b>Temperature range</b>	<p>For temperature limits depending on fluid compatibility → <b>table 8, page 32</b></p> <ul style="list-style-type: none"> <li><span style="color: blue;">■</span> Extreme low temperature range: may be intermittently exposed (e.g. cold start-up) without seal damage, but seal performance may be compromised while in this range</li> <li><span style="color: gray;">■</span> Temperatures below the recommended operating range: seal performance depends on system design</li> <li><span style="color: green;">■</span> <b>Recommended operating temperature range for this profile and material.</b></li> <li><span style="color: yellow;">■</span> Temperatures above the recommended operating range: acceptable only with reduced pressure and/or speed</li> <li><span style="color: red;">■</span> Extreme high temperature range: only occasional short term exposure (e.g. cylinder in curing oven of a powder coating process)</li> </ul>
<b>Dimension standards</b>	Some sizes fit seal housings in accordance with ISO 6547.
<b>Counter-surface</b>	→ <b>page 22</b>

Maximum values of application parameters (e.g. pressure, speed, temperature, e-gap) should not be applied continuously nor simultaneously.

## 2.11 MD-L profile piston seals, metric sizes

D 25 – 63 mm

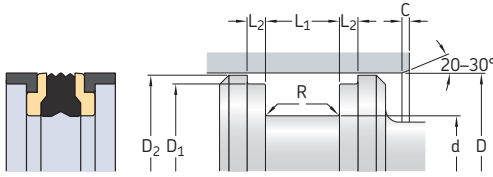

Cylinder dimensions								Designation
D	d	L <sub>1</sub>	L <sub>2</sub>	D <sub>1</sub>	D <sub>2</sub>	R	C	
H9	h9	+0,1/+0,35	+0,2	h9	h11	max.	min.	
mm								-
25	15	12,4	4	21	23	0,4	2,5	MD 25x15x12.4-L
30	21	13,5	2,1	27	29	0,4	2,5	MD 30x21x13.5-L
32	22	12,5	4	29	31	0,4	2,5	• MD 32x22x12.5-L
	24	10	4	29	31	0,4	2	• MD 32x24x10-L
	24	15,5	3,2	28	31,4	0,4	2	MD 32x24x15.5-L
35	25	15,5	2,6	31	34	0,4	2,5	MD 35x25x15.5-L
	25	16,4	6,4	31,4	33,5	0,4	2,5	MD 35x25x16.4-L
40	24	18,4	6,4	35,4	38,7	0,4	4	MD 40x24x18.4-L
	30	12,4	4	36	38	0,4	2,5	MD 40x30x12.4-L
	30	12,5	4	37	39	0,4	2,5	• MD 40x30x12.5-L
	30	16,4	6,4	35,4	38,7	0,4	2,5	MD 40x30x16.4-L
	32	15,5	3,2	36	39,4	0,4	2	MD 40x32x15.5-L
45	29	18,4	6,4	40,4	43,7	0,4	4	MD 45x29x18.4-L
	37	15,5	3,2	41,0	43,5	0,4	2	MD 45x37x15.5-L
50	34	18,4	6,4	45,4	48,7	0,4	4	MD 50x34x18.4-L
	35	20	5	46	48,5	0,4	4	• MD 50x35x20-L
	38	20,5	4,2	46	49,4	0,4	3	MD 50x38x20.5-L
	40	12,5	4	47	49	0,4	2,5	• MD 50x40x12.5-L
55	39	18,4	6,4	50,4	53,7	0,4	4	MD 55x39x18.4-L
	39	20,5	3,1	51	54	0,4	4	MD 55x39x20.5-L
	45	12,5	4	52	54	0,4	2,5	MD 55x45x12.5-L
60	44	18,4	6,4	55,4	58,7	0,4	4	MD 60x44x18.4-L
	48	20,5	4,2	56	59,4	0,4	3	MD 60x48x20.5-L
63	47	18,4	6,4	58,4	61,5	0,4	4	MD 63x47x18.4-L
	47	19,4	6,4	58,4	61,7	0,4	4	MD 63x47x19.4-L
	47	20,5	3,1	59	62	0,4	4	MD 63x47x20.5-L
	48	20	5,0	59	61,5	0,4	4	• MD 63x48x20-L
	51	20,5	4,2	59	62,4	0,4	3	MD 63x51x20.5-L
	53	12,5	4	60	62	0,4	2,5	• MD 63x53x12.5-L

• Dimensions in accordance with ISO 6547

## 2.11 MD-L profile piston seals, metric sizes

D 65 – 250 mm

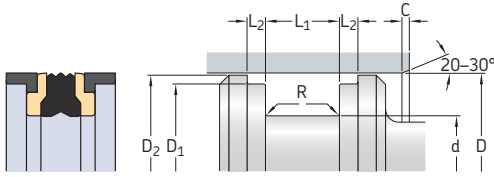

Cylinder dimensions								Designation
D H9	d h9	L <sub>1</sub> +0,1/+0,35	L <sub>2</sub> +0,2	D <sub>1</sub> h9	D <sub>2</sub> h11	R max.	C min.	
mm								-
65	50	18,4	6,4	60,4	63,7	0,4	4	MD 65x50x18.4-L
70	50	22,4	6,4	64,2	68,3	0,8	5	MD 70x50x22.4-L
	54	20,5	3,1	66	69	0,4	4	MD 70x54x20.5-L
	55	20	5	66	68,5	0,4	4	MD 70x55x20-L
	58	20,5	4,2	66	69,4	0,4	3	MD 70x58x20.5-L
75	55	22,4	6,4	69,2	73,3	0,8	5	MD 75x55x22.4-L
80	60	22,4	6,4	74,2	78,3	0,8	5	MD 80x60x22.4-L
	60	25	6,3	75	78	0,8	5	• MD 80x60x25-L
	62	22,5	3,6	76	79	0,4	4,5	MD 80x62x22.5-L
	65	20	5	76	78,5	0,4	4	• MD 80x65x20-L
	66	22,5	5,2	76	79,4	0,4	3,5	MD 80x66x22.5-L
85	65	22,4	6,4	79,2	83,3	0,8	5	MD 85x65x22.4-L
90	70	22,4	6,4	84,2	88,3	0,8	5	MD 90x70x22.4-L
	72	22,5	3,6	86	89	0,4	4,5	MD 90x72x22.5-L
	75	20	5	86	88,5	0,4	4	MD 90x75x20-L
95	75	22,4	6,4	89	93,3	0,8	5	MD 95x75x22.4-L
100	75	22,4	6,4	93,2	98	0,8	6,5	MD 100x75x22.4-L
	80	25	6,3	95	98	0,8	5	• MD 100x80x25-L
	85	20	5	96	98,5	0,4	4	• MD 100x85x20-L
	86	22,5	5,2	96	99,4	0,4	3,5	MD 100x86x22.5-L
105	92,5	14,0	5,2	99,0	103,5	0,4	3,5	MD 105x92.5x14-L
110	85	22,4	6,4	103,1	108	0,8	6,5	MD 110x85x22.4-L
	85	25,4	6,4	103,1	108	0,8	6,5	MD 110x85x25.4-L
	95	20	5	106	108,5	0,4	4	MD 110x95x20-L
	96	22,5	5,2	106	109,4	0,4	3,5	MD 110x96x22.5-L
115	90	22,4	6,4	108,1	113	0,8	6,5	MD 115x90x22.4-L
120	95	22,4	6,4	113,1	118	0,8	6,5	MD 120x95x22.4-L

• Dimensions in accordance with ISO 6547

Cylinder dimensions								Designation
D H9	d h9	L <sub>1</sub> +0,1/+0,35	L <sub>2</sub> +0,2	D <sub>1</sub> h9	D <sub>2</sub> h11	R max.	C min.	
mm								-
125	100	25,4	6,4	118,1	123	0,8	6,5	MD 125x100x25.4-L
	100	32	10	119	123	0,8	6,5	• MD 125x100x32-L
	105	25	6,3	120	123	0,8	5	• MD 125x105x25-L
	105	25,4	6,4	119,1	123,3	0,8	5	MD 125x105x25.4-L
	108	26,5	7,2	121	124,4	0,4	4,5	MD 125x108x26.5-L
130	105	25,4	6,4	123,1	128	0,8	6,5	MD 130x105x25.4-L
140	115	25,4	6,4	133	138	0,8	6,5	MD 140x115x25.4-L
	120	25	6,3	135	138	0,8	5	MD 140x120x25-L
145	120	25,4	6,4	138,3	143	0,8	6,5	MD 145x120x25.4-L
150	125	25,4	6,4	143	148	0,8	6,5	MD 150x125x25.4-L
160	130	25,4	6,4	153	157,9	0,8	7,5	MD 160x130x25.4-L
	135	25,4	9,5	152,6	157,5	0,8	6,5	MD 160x140x25-L
	140	25	6,3	155	158	0,8	5	• MD 160x140x25-L
170	145	25,4	12,7	161,7	167,1	0,8	6,5	MD 170x145x25.4x12.7-L
180	150	35,4	6,4	173	178	0,8	7,5	MD 180x150x35.4-L
	155	25,4	12,7	171,7	177,7	0,8	6,5	MD 180x155x25.4x12.7-L
200	170	35,4	6,4	193	198	0,8	7,5	MD 200x170x35.4-L
	170	36	12,5	192	197	0,8	7,5	• MD 200x170x36-L
	180	31,5	9,2	196	199,4	0,8	5	MD 200x180x31.5-L
220	190	35,4	6,4	213	218	0,8	7,5	MD 220x190x35.4-L
	195	25,4	12,7	211,6	217	0,8	6,5	MD 220x195x25.4x12.7-L
250	220	35,4	6,4	243	248	0,8	7,5	MD 250x220x35.4-L

Other sizes are available on request

## UNP profile data



<b>Materials</b>	Metric sizes → TPU U-1029 Inch size → TPU U-1023 For additional information → <b>page 26</b>
<b>Pressure</b>	Up to 350 bar (5 075 psi)
<b>Speed</b>	Pressure ≤ 250 bar (3 625 psi) → up to 1 m/s (3.2 ft/s) Pressure ≤ 350 bar (5 075 psi) → up to 0,5 m/s (1.6 ft/s)
<b>Temperature range</b>	<p>For temperature limits depending on fluid compatibility → <b>table 8, page 32</b></p> <ul style="list-style-type: none"> <li><span style="color: blue;">■</span> Extreme low temperature range: may be intermittently exposed (e.g. cold start-up) without seal damage, but seal performance may be compromised while in this range</li> <li><span style="color: grey;">■</span> Temperatures below the recommended operating range: seal performance depends on system design (precision guiding arrangement recommended)</li> <li><span style="color: green;">■</span> <b>Recommended operating temperature range for this profile and material</b></li> <li><span style="color: yellow;">■</span> Temperatures above the recommended operating range: acceptable only with reduced pressure, speed, e-gap and/or with the use of a full-face anti-extrusion ring</li> <li><span style="color: red;">■</span> Extreme high temperature range: only occasional short term exposure (e.g. cylinder in curing oven of a powder coating process)</li> </ul>
<b>Counter-surface</b>	→ <b>page 22</b>

Maximum values of application parameters (e.g. pressure, speed, temperature, e-gap) should not be applied continuously nor simultaneously.



## 2.12 UNP profile piston seals, metric sizes

D 45 – 250 mm

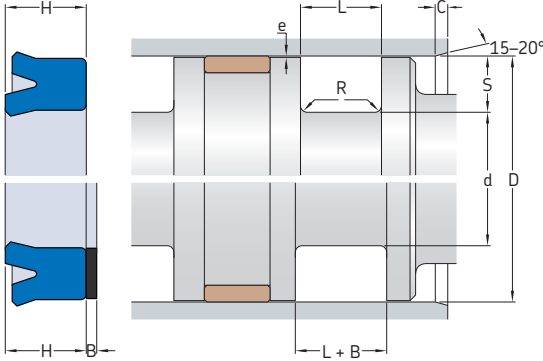

### Maximum extrusion gap e

Radial depth S	e <sub>max</sub> at 80 °C (175 °F) for pressures		
	160 bar	250bar	350 bar
mm	mm		
5	0,45	0,25	0,1
7,5	0,5	0,3	0,15
10	0,55	0,3	0,15
12,5	0,6	0,3	0,2

With and without full-face anti-extrusion ring<sup>1)</sup>

### Cylinder dimensions

### Designation

D	d	L	L + B	H	S	R	C	Designation
H9	h9	+0,2	+0,2	nom.		max.	min.	
mm								-
45	35	7	9	6	5	0,4	5	UNP-45x35x7-E6W
50	40	7	9	6	5	0,4	5	UNP-50x40x7-E6W
	40	8,3	10,3	7,3	5	0,4	5	UNP-50x40x8.3-E6W
63	48	11	13	10	7,5	0,5	7	UNP-63x48x11-E6W
	53	7	9	6	5	0,4	5	UNP-63x53x7-E6W
	53	8,3	10,3	7,3	5	0,4	5	UNP-63x53x8.3-E6W
75	65	7	9	6	5	0,4	5	UNP-75x65x7-E6W
130	115	10	12	9	7,5	0,5	7	UNP-130x115x10-E6W
140	120	16,5	18,5	15	10	0,75	7	UNP-140x120x16.5-E6W
150	135	10	12	9	7,5	0,6	7	UNP-150x135x10-E6W
160	140	16	18	14,5	10	0,75	7	UNP-160x140x15.5-E6W
170	150	13,2	15,2	12	10	0,75	7	UNP-170x150x13-E6W
	155	10	12	9	7,5	0,5	7	UNP-170x155x10-E6W
180	150	20	22	18	15	0,75	7	UNP-180x150x19.5-E6W
	165	10	12	9	7,5	0,5	7	UNP-180x165x10-E6W
190	175	10	12	9	7,5	0,5	7	UNP-190x175x10-E6W
200	175	20,2	22,2	18,2	12,5	0,75	12	UNP-200x175x19.7-E6W
210	190	13,2	15,2	12	10	0,75	7	UNP-210x190x13-E6W
220	200	16,5	18,5	15	10	0,75	7	UNP-220x200x16.5-E6W
230	205	22	24	20	12,5	0,75	12	UNP-230x205x22-E6W
240	220	13,2	15,2	12	10	0,75	7	UNP-240x220x13-E6W
250	230	16,5	18,5	15	10	0,75	7	UNP-250x230x16.5-E6W

<sup>1)</sup> Appropriate full-face anti-extrusion rings, e.g. BUS profile, are not covered in this catalogue but available on request. For additional information, contact SKF.

## 2.12 UNP profile piston seals, metric sizes

D 280 – 300 mm

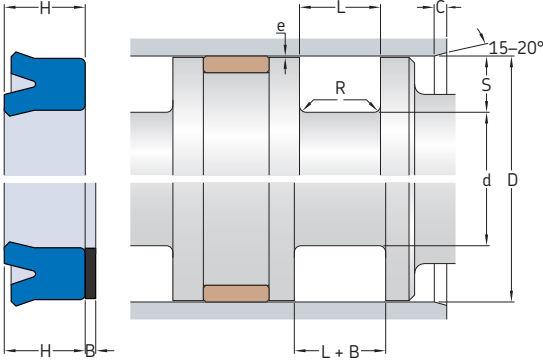

### Maximum extrusion gap e

Radial depth S  
 $e_{max}$  at 80 °C (175 °F)  
 for pressures

S	160 bar	250bar	350 bar
mm	mm		
5	0,45	0,25	0,1
7,5	0,5	0,3	0,15
10	0,55	0,3	0,15
12,5	0,6	0,3	0,2

With and without full-face anti-extrusion ring<sup>1)</sup>

### Cylinder dimensions

### Designation

D	d	L	L + B	H	S	R	C	Designation
H9	h9	+0,2	+0,2	nom.		max.	min.	
mm								-
280	255	21	23	19	12,5	0,75	12	UNP-280x255x20.5-E6W
290	265	21	23	19	12,5	0,75	12	UNP-290x265x20.5-E6W
300	275	17,6	19,6	16	12,5	0,75	12	UNP-300x275x17.5-E6W

Other sizes are available on request

<sup>1)</sup> Appropriate full-face anti-extrusion rings, e.g. BUS profile, are not covered in this catalogue but available on request. For additional information, contact SKF.

## 2.12 UNP profile piston seals, inch sizes

D 1.125 – 5 in.

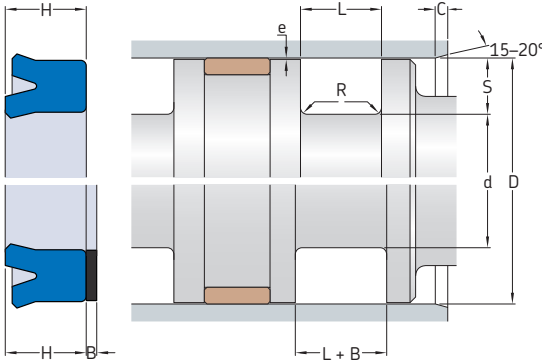

### Maximum extrusion gap e

Radial depth S	e <sub>max</sub> at 80 °C (175 °F) for pressures		
	2 300 psi	3 600 psi	5 075 psi
in.	in.		
0.187	0.018	0.01	0.004
0.25	0.02	0.012	0.006
0.375	0.022	0.012	0.006
0.5	0.024	0.012	0.008

With and without full-face anti-extrusion ring<sup>1)</sup>

### Cylinder dimensions

### Designation

D	Tolerance	d	Tolerance	L +0.1	L+B +0.1	H nom.	S	R max.	C min.	Designation
in.										-
1.125	+0.002	0.75	-0.002	0.343	0.437	0.312	0.187	0.015	0.25	UNP187-750-312-H9J
1.5	+0.002	1.125	-0.002	0.275	0.369	0.25	0.187	0.015	0.25	UNP187-1125-250-H9J
	+0.002	1.25	-0.002	0.275	0.338	0.25	0.125	0.01	0.25	UNP125-1250-250-H9J
1.75	+0.002	1.375	-0.002	0.275	0.369	0.25	0.187	0.015	0.25	UNP187-1375-250-H9J
2	+0.002	1.625	-0.002	0.206	0.299	0.187	0.187	0.015	0.25	UNP187-1625-187-H9J
	+0.002	1.625	-0.002	0.343	0.437	0.312	0.187	0.015	0.25	UNP187-1625-312-H9J
2.25	+0.002	1.875	-0.002	0.343	0.437	0.312	0.187	0.015	0.25	UNP187-1875-312-H9J
2.5	+0.003	2	-0.003	0.413	0.538	0.375	0.25	0.02	0.312	UNP250-2000-375-H9J
	+0.002	2.125	-0.002	0.275	0.369	0.25	0.187	0.015	0.25	UNP187-2125-250-H9J
	+0.002	2.125	-0.002	0.413	0.506	0.375	0.187	0.015	0.25	UNP187-2125-375-H9J
2.625	+0.002	2.25	-0.002	0.343	0.437	0.312	0.187	0.015	0.25	UNP187-2250-312-H9J
2.75	+0.003	2.25	-0.003	0.413	0.538	0.375	0.25	0.02	0.312	UNP250-2250-375-H9J
3	+0.002	2	-0.007	0.550	0.800	0.5	0.5	0.04	0.375	UNP500-2000-500-H9J
	+0.003	2.5	-0.003	0.343	0.468	0.312	0.25	0.02	0.312	UNP250-2500-312-H9J
	+0.003	2.5	-0.003	0.413	0.538	0.375	0.25	0.02	0.312	UNP250-2500-375-H9J
	+0.002	2.625	-0.002	0.413	0.506	0.375	0.187	0.015	0.25	UNP187-2625-375-H9J
3.25	+0.005	2.25	-0.007	0.550	0.800	0.5	0.5	0.04	0.375	UNP500-2250-500-H9J
	+0.002	2.875	-0.002	0.413	0.506	0.375	0.187	0.015	0.25	UNP187-2875-375-H9J
3.5	+0.004	2.75	-0.005	0.688	0.875	0.625	0.375	0.032	0.375	UNP375-2750-625-H9J
	+0.003	3	-0.003	0.413	0.538	0.375	0.25	0.02	0.312	UNP250-3000-375-H9J
4	+0.005	3	-0.007	0.550	0.800	0.5	0.5	0.04	0.375	UNP500-3000-500-H9J
	+0.003	3.5	-0.003	0.413	0.538	0.375	0.25	0.02	0.312	UNP250-3500-375-H9J
4.5	+0.004	3.75	-0.005	0.688	0.875	0.625	0.375	0.032	0.375	UNP375-3750-625-H9J
5	+0.004	4.25	-0.005	0.550	0.738	0.5	0.375	0.032	0.375	UNP375-4250-500-H9J
	+0.003	4.5	-0.003	0.413	0.538	0.375	0.25	0.02	0.312	UNP250-4500-375-H9J

<sup>1)</sup> Appropriate full-face anti-extrusion rings, e.g. BUS profile, are not covered in this catalogue but available on request. For additional information, contact SKF.

## 2.12 UNP profile piston seals, inch sizes

D 5.5 – 6.5 in.

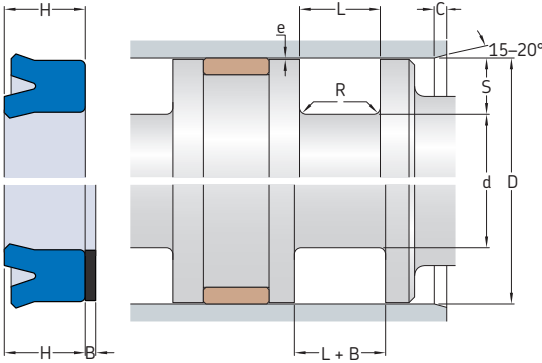

### Maximum extrusion gap e

Radial depth S  
 emax at 80 °C (175 °F)  
 for pressures

2 300 psi 3 600 psi 5 075 psi

in. in.

<b>0.187</b>	0.018	0.01	0.004
<b>0.25</b>	0.02	0.012	0.006
<b>0.375</b>	0.022	0.012	0.006
<b>0.5</b>	0.024	0.012	0.008

With and without full-face anti-extrusion ring<sup>1)</sup>

### Cylinder dimensions

### Designation

D	Tolerance	d	Tolerance	L	L+B	H	S	R	C	Designation
				+0.1	+0.1	nom.		max.	min.	
in.										-
5.5	+0.004	4.75	-0.005	0.688	0.875	0.625	0.375	0.032	0.375	<b>UNP375-4750-625-H9J</b>
6	+0.004	5.25	-0.005	0.413	0.600	0.375	0.375	0.032	0.375	<b>UNP375-5250-375-H9J</b>
6.5	+0.004	5.75	-0.005	0.688	0.875	0.625	0.375	0.032	0.375	<b>UNP375-5750-625-H9J</b>

Other sizes are available on request

<sup>1)</sup> Appropriate full-face anti-extrusion rings, e.g. BUS profile, are not covered in this catalogue but available on request. For additional information, contact SKF.



## Piston seals

### More piston seals

The piston seals listed in this catalogue represent the preferred profiles in common sizes. SKF supplies many additional sizes and profiles. The following profiles are also manufactured in series production. For additional information about these profiles or if the application requires a solution outside of what is provided in this catalogue, contact SKF. SKF can provide customized sealing solutions for the toughest application conditions.

#### PTFE slide ring piston seals

Piston seals with PTFE slide rings are available in a wide variety of profiles and materials (→ **fig. 18**). For additional information about material options, contact SKF.

#### SPECTRASEAL

SPECTRASEAL is a PTFE seal that can be used as a single-acting piston seal (→ **fig. 19**). The metal spring energizer adds radial load to the seal lip contact areas. SPECTRASEAL is intended for extreme condition applications including high temperature or aggressive media. For additional information, contact SKF.

#### Customized machined seal profiles

SKF can manufacture a broad variety of piston seal profiles with different materials and sizes with its industry-leading SKF SEAL JET production system (→ **fig. 20**). For additional information about customized machined profiles, refer to publication *Customized machined seals – Product range* or contact SKF.

Fig. 18

PTFE slide ring piston seals, profile examples

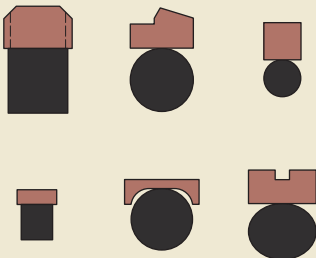

Fig. 19

SPECTRASEAL

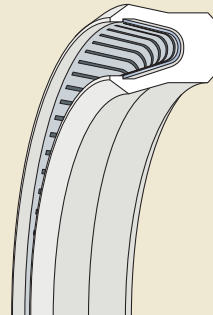

Fig. 20

SKF SEAL JET profile examples



K01-P



K01-PE



K01-R



K01-RE



K02-P



K02-PD



K02-R



K02-RD



K03-P

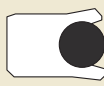

K03-F

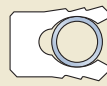

K03-5



K04-P



K04-PD



K05-P



K05-R



K06-P



K06-R



K07-P



K07-F



K08-E

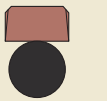

K08-D



K08-P



K08-ES

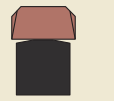

K08-D5



K09-N



K09-D

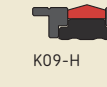

K09-H



K09-F

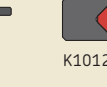

K1012-T



K1012-M



K1315-T



K16-A



K16-B



K17-P



K17-R

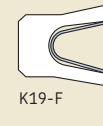

K19-F

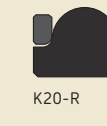

K20-R



K21-P



K22-P

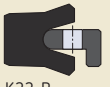

K22-R

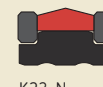

K23-N



K23-D



K23-H



K23-F



K24-P



K32-P



K35-P

2

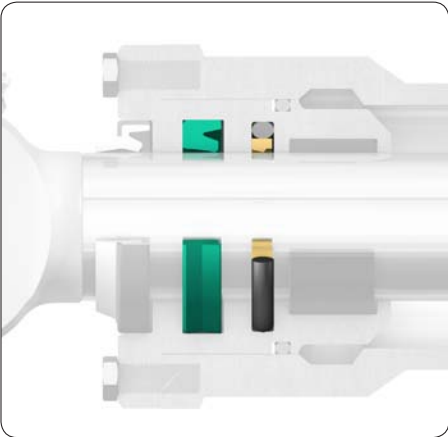
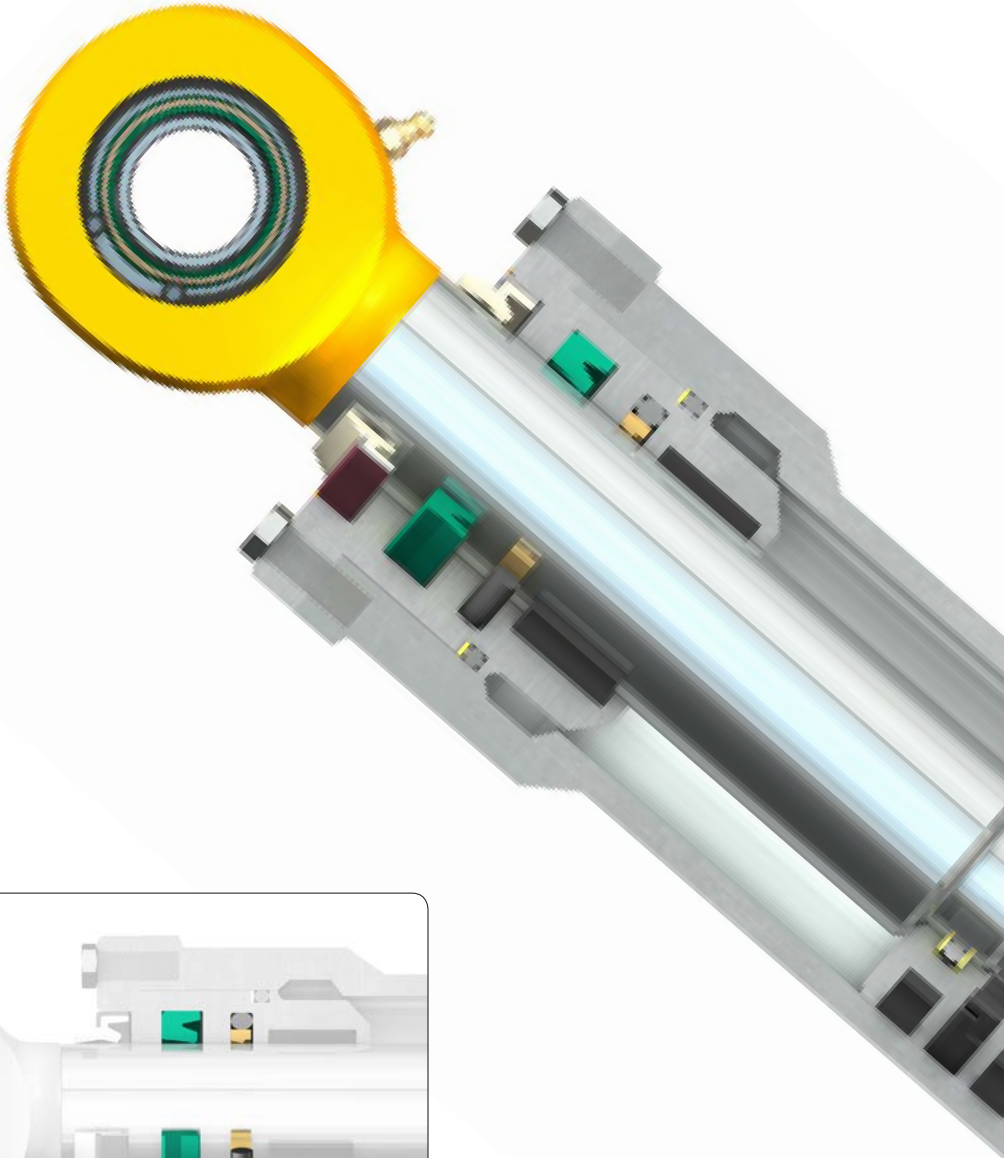













# Rod and buffer seals

<b>Profile overview</b> .....	<b>112</b>	<b>Profile data</b>	
<b>Basics</b> .....	<b>114</b>	<b>3.1</b> S1S .....	122
Rod sealing systems .....	114	Metric sizes .....	123
Materials .....	114	<b>3.2</b> ZBR .....	126
Anti-extrusion rings .....	115	Metric sizes .....	127
Rod guidance .....	115	Inch sizes .....	131
<b>Rod seals</b> .....	<b>116</b>	<b>3.3</b> SIL .....	134
Polyurethane U-cup rod seals .....	116	Metric sizes .....	135
S1S profiles .....	116	<b>3.4</b> PTB .....	138
ZBR profiles .....	116	Metric sizes .....	139
SIL profiles .....	117	Inch sizes .....	149
Energized U-cup rod seals .....	117	<b>3.5</b> STD .....	164
PTB profiles .....	117	Inch sizes .....	165
STD profiles .....	118	<b>3.6</b> DZ .....	178
Hybrid rod seals .....	118	Metric sizes .....	179
DZ profile .....	118	Inch sizes .....	180
DZR profile .....	119	<b>3.7</b> DZR .....	184
<b>Buffer seals</b> .....	<b>120</b>	Metric sizes .....	185
Polyurethane U-cup buffer seals .....	120	Inch sizes .....	186
RBB profile .....	120	<b>3.8</b> RBB .....	188
Buffer seals incorporating slide rings ..	120	Metric sizes .....	189
S9B profile .....	120	Inch sizes .....	191
RSB profile .....	121	<b>3.9</b> S9B .....	192
		Metric sizes .....	193
		Inch sizes .....	196
		<b>3.10</b> RSB .....	198
		Inch sizes .....	199
		<b>More rod and buffer seals</b> .....	<b>202</b>
		Rod locking T-seals .....	202
		TEFLATHANE seals .....	202
		Chevron sets .....	202
		SPECTRASEAL .....	203
		Customized machined seal profiles .....	204

## Profile overview

Profile	Description	Additional information → page	Profile data → page
<b>S1S</b> 	Single-lip U-cup profile made of polyurethane; suitable for heavy duty applications	<b>116</b>	<b>122</b> (metric)
<b>ZBR</b> 	Double lip U-cup profile made of polyurethane; suitable for heavy duty applications	<b>116</b>	<b>126</b> (metric and inch)
<b>SIL</b> 	Double lip U-cup profile made of polyurethane ; suitable for low temperatures and light to medium duty applications	<b>117</b>	<b>134</b> (metric)
<b>PTB</b> 	Polyurethane U-cup profile with incorporated nitrile rubber X-ring, which provides good performance even at low pressure and temperature	<b>117</b>	<b>138</b> (metric and inch)
<b>STD</b> 	Polyurethane U-cup profile with incorporated nitrile rubber X-ring, which provides good performance even at low pressure and temperature; narrow housings	<b>118</b>	<b>164</b> (inch)
<b>DZ</b> 	Nitrile rubber primary sealing ring, polyurethane secondary sealing ring; low friction; suitable for heavy duty applications	<b>118</b>	<b>178</b> (metric and inch)
<b>DZR</b> 	Nitrile rubber primary sealing ring, polyurethane secondary sealing ring, integrated triangular polyamide anti-extrusion ring; improved gap extrusion resistance; suitable for heavy duty applications and extreme pressures	<b>119</b>	<b>184</b> (metric and inch)

Profile	Description	Additional information → page	Profile data → page
<b>RBB</b> 	Buffer seal with polyurethane sealing ring, integrated anti-extrusion ring; designed to vent pressure back to system side; improved gap extrusion resistance at abrupt pressure peaks; fits narrow grooves; suitable for heavy duty applications	<b>120</b>	<b>188</b> (metric and inch)
<b>S9B</b> 	Nitrile rubber O-ring energizer, PTFE slide ring; also available with polyurethane slide ring to improve wear resistance and ease installation	<b>120</b>	<b>192</b> (metric and inch)
<b>RSB</b> 	Buffer seal with PTFE slide ring, nitrile rubber energizer; patented and improved design to reduce pressure peaks acting on the rod seal and vent pressure back to system side; improved gap extrusion resistance at abrupt pressure peaks; suitable for heavy duty applications	<b>121</b>	<b>198</b> (inch)

# Basics

## Rod sealing systems

Rod and buffer seals maintain sealing contact in sliding motion between the cylinder head and the piston rod. Depending on the application, a rod sealing system can consist of a rod seal and a buffer seal (→ **fig. 1**) or a rod seal only (→ **fig. 2**). Rod sealing systems for heavy duty applications typically consist of a combination of both seal types, whereas the buffer seal is arranged between the rod seal and the piston in the cylinder head.

In addition to the sealing function, rod seals also provide a thin lubrication film on the piston rod that lubricates themselves and the wiper seals. The lubricant also inhibits corrosion of the piston rod surface. However, the lubrication film must be thin enough so that it returns to the cylinder during the return stroke.

Selecting profiles and materials for a rod sealing system is a complex task, considering all cylinder designs and application criteria. SKF supplies rod and buffer seals in many different profiles and in a wide range of materials, series and sizes, which make them appropriate for a wide variety of operating conditions and applications.

## Materials

Depending on the profile and the required characteristics of its components, rod and buffer seals can consist of one or several

### More information

Counter-surface finish properties . . . . .	22
Materials . . . . .	26
Hydraulic fluids . . . . .	31
Gap extrusion . . . . .	34
Storage . . . . .	36
Installation and assembly . . . . .	38

Fig. 1

Typical rod seal arrangement for heavy duty hydraulic applications

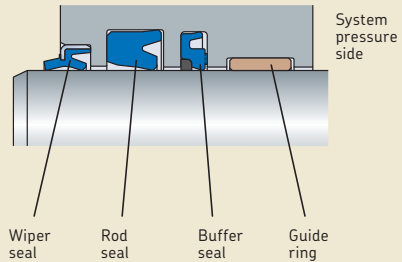
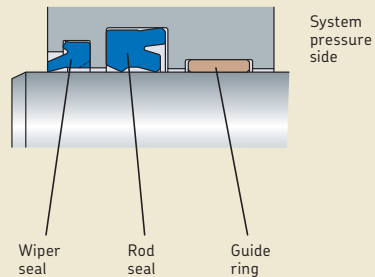

Fig. 2

Typical rod seal arrangement for light to medium duty hydraulic applications



materials. Common materials used for the sealing and energizing elements of rod and buffer seals are thermoplastic polyurethane (TPU), polytetrafluoroethylene (PTFE) or nitrile rubber (NBR). Common materials used for rod seal anti-extrusion rings are polyamide (PA), polyacetal (POM) or PTFE. The materials used for a specific profile are provided in the *Profile overview* (→ **page 112**) and in the relevant profile sections below.

For additional information, refer to *Materials* (→ **page 26**).

Fig. 3

## Anti-extrusion rings

External forces acting on the rod can cause pressure peaks. They can be far in excess of the system operating pressure and may press a rod seal into the gap between the piston rod and the cylinder head. This risk of gap extrusion can be avoided for rod and buffer seals by using anti-extrusion rings. These hard and temperature-resistant rings can be integrated in the seal or a separate full-face anti-extrusion ring can be used. This ring can be added to a rod seal by simply extending the groove length (→ **fig. 3**). Integrated anti-extrusion rings fit into a notch in the rod or buffer seal and do not need a longer groove.

DZR (→ **fig. 10, page 119**) profile rod seals and RBB (→ **fig. 11, page 120**) profile buffer seals incorporate an anti-extrusion ring. Other U-cup and energized U-cup rod seals with an integrated anti-extrusion ring are available on request. Full-face anti-extrusion rings for rod and buffer seals, for example BUS profile, are not covered in this catalogue, but are available also on request. For additional information about anti-extrusion rings, contact SKF.

Integrated and full-face anti-extrusion rings

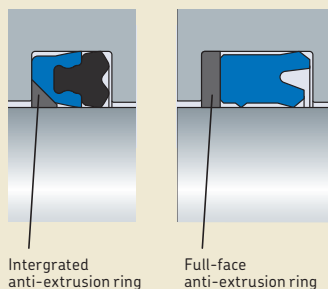

Integrated anti-extrusion ring

Full-face anti-extrusion ring

## Rod guidance

Guide rings avoid sliding contact between the piston rod and cylinder head surfaces and react the radial loads of forces acting on the cylinder assembly. Although rod sealing systems are designed to accommodate slight radial motion between the piston rod and head, effective guide ring function to accurately centre the rod within the head is important for rod seal performance. For additional information about rod guidance, refer to *Guide rings and guide strips* (→ **page 249**).

## Rod seals

Rod seals are typically single-acting seals, which means that fluid pressure acts from inside the cylinder on one seal side only. Pressures acting on the rod side of the piston can be in excess of 400 bar (5 800 psi), pressure peaks can be even higher. The pressure acting on the rod seal increases contact forces between the rod seal and cylinder surfaces. Therefore, rod seal materials should be wear resistant and the rod surface need to be manufactured to the recommended specifications (→ *Counter-surface finish properties*, page 22).

### Polyurethane U-cup rod seals

U-cup seals, as their name implies, have an U-shaped profile, including an outside static sealing lip and an inside dynamic sealing lip. The unique combination of resilience and its resistance to gap extrusion and wear makes thermoplastic polyurethane (TPU) the most common material used for U-cup seals in hydraulic application. When installed, the radial compression of the sealing lips provides adequate sealing force between the sealing lips and the cylinder components.

These U-cup seals are suitable for heavy duty applications. They are available with a single or double lip design, whereas the single lip design is preferred. However, depending on the application, system design, size and individual customer preferences, it may be preferable to use a U-cup with a secondary dynamic sealing lip.

### S1S profiles

S1S profiles (→ fig. 4) are made of ECOPUR (TPU) and have a single lip design. The geometry has been optimized using advanced FEM (Finite Element Modeling) and simulation techniques to provide the longest possible maintenance-free service. They are suitable for pressures up to 400 bar (5 800 psi) in heavy duty applications and are available in metric sizes.

### ZBR profiles

ZBR profiles (→ fig. 5) are made of LUBRITHANE (TPU) and have a double lip design. They are suitable for pressures up to 400 bar (5 800 psi) in heavy duty applications and are available in metric and inch sizes.

Fig. 4

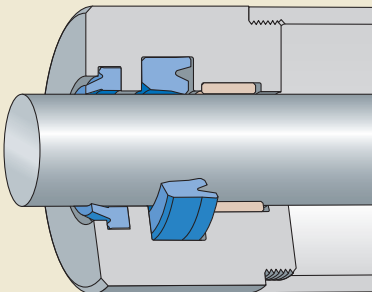

S1S

Fig. 5

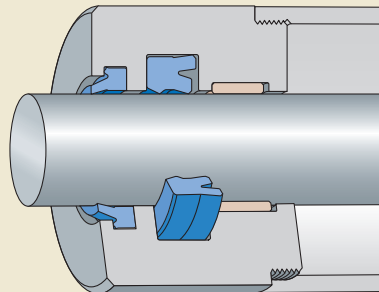

ZBR

### SIL profiles

SIL profiles (→ **fig. 6**) are made of ether-based TPU and have a double lip design. They provide good resistance to hydrolysis (attack from moisture) and good low temperature resilience. These profiles are suitable for pressures up to 350 bar (5 075 psi) for light to medium duty applications and are available in metric sizes.

### Energized U-cup rod seals

Energized U-cup rod seals incorporate a nitrile rubber (NBR) X-ring in their thermoplastic polyurethane (TPU) U-cup. The X-ring serves as energizer, provides additional sealing force and improves the long-term resilience of the sealing lips. This can be beneficial in applications with low operating pressure or low temperatures.

### PTB profiles

PTB profiles (→ **fig. 7**) are made of LUBRITHANE (TPU). Its type-B back-bevel sealing lip design with a chamfer on the leading edge regulates the fluid film on the piston rod surface. These profiles are suitable for pressures up to 400 bar (5 800 psi) and are available in metric and inch sizes. Some metric sizes fit seal housings in accordance with ISO 5597.

Fig. 6

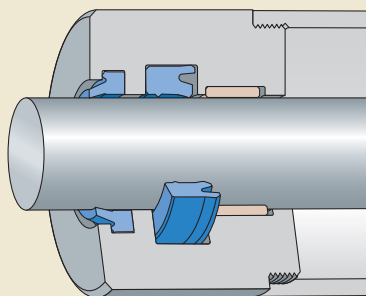

SIL

Fig. 7

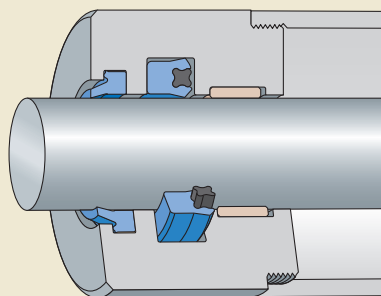

PTB

## Rod and buffer seals

### STD profiles

STD profiles (→ **fig. 8**) are made of LUBRITHANE (TPU). They are suitable for pressures up to 400 bar (5 800 psi) and can also be used as a heavy-duty static seal or a snap-in wiper seal. These profiles are available in inch sizes where narrower seal housings are used. Metric sizes are available on request.

### Hybrid rod seals

Hybrid rod seals incorporate dynamic sealing lips of different materials. These material combinations provide a hybrid with the functional benefit of each material and, therefore, a robust rod seal. An example is the sealing ability and resilience of nitrile rubber (NBR) combined with the extrusion and wear resistance of polyurethane (TPU).

### DZ profile

DZ profiles (→ **fig. 9**) combine a NBR primary sealing lip with a LUBRITHANE (TPU) secondary sealing lip into one seal. This combination provides a good low temperature resilience and is suitable for pressures up to 400 bar (5 800 psi). DZ profiles are available in metric and inch sizes. They are also available with an elastomer (FLUOROTREL/TPC) secondary sealing lip on request.

These hybrid rod seal profiles from SKF are the original of its kind and the first to be introduced into the market. DZ profiles are well established in the market.

Fig. 8

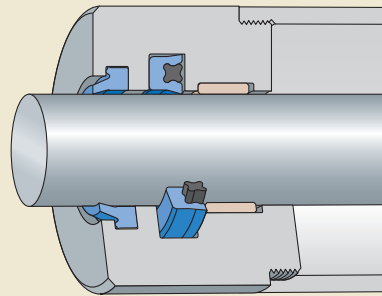

STD

Fig. 9

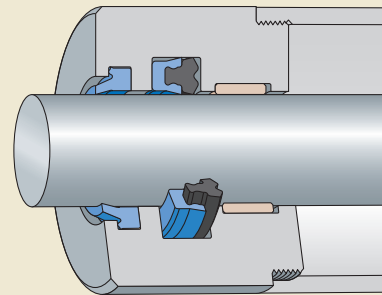

DZ



Fig. 10

### DZR profile

DZR profiles (→ **fig. 10**) combine a NBR primary sealing lip, a LUBRITHANE (TPU) secondary sealing lip and a triangular polyamide (PA) anti-extrusion ring (→ *Anti-extrusion rings*, **page 115**) into one seal. These combinations provide good low temperature resilience, and improved resistance to deformation, wear, and gap extrusion. They are suitable for pressures up to 690 bar (10 000 psi) and for extreme heavy duty applications. DZR profiles are available in metric and inch sizes.

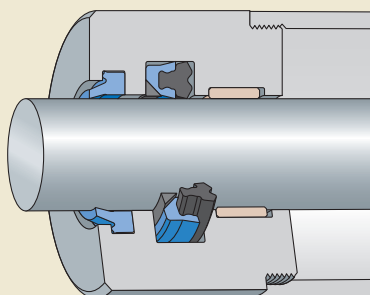

DZR

### Buffer seals

Buffer seals protect the rod seals by reducing pressure peaks. Abrupt pressure peaks can occur by external forces acting on the piston rod, initiated by the fluid inside the cylinder. These pressure peaks can be far in excess of the system operating pressure. Buffer seals in combination with rod seals provide an effective rod sealing system for cylinders in heavy duty applications at high temperature and pressure.

#### Polyurethane U-cup buffer seals

##### RBB profile

RBB profiles (→ **fig. 11**) have a LUBRITHANE (polyurethane/TPU) sealing ring that incorporates a polyamide (PA) or polyacetal (POM) anti-extrusion ring. The flexible outside static sealing lip and channels in the front face ensure that pressure can return to the system side of the buffer and prevent build up of pressure between the rod and buffer seals. These profiles are suitable for pressure peaks and demanding workloads in heavy duty applications up to 690 bar (10 000 psi). They are available in metric and inch sizes.

#### Buffer seals incorporating slide rings

##### S9B profile

S9B profiles (→ **fig. 12**) have a nitrile rubber (NBR) O-ring energizer and a PTFE slide ring as standard. Depending on the application, SKF can manufacture the slide rings from a variety of PTFE materials. On request, SKF can supply these profiles also with X-ECOPUR polyurethane (TPU) slide rings for improved wear resistance and ease of installation compared to PTFE. S9B profiles with a PTFE slide ring are suitable for pressures up to 400 bar (5 800 psi), those with an X-ECOPUR slide ring up to 600 bar (8 700 psi). Both material combinations are available in metric and inch sizes.

Fig. 11

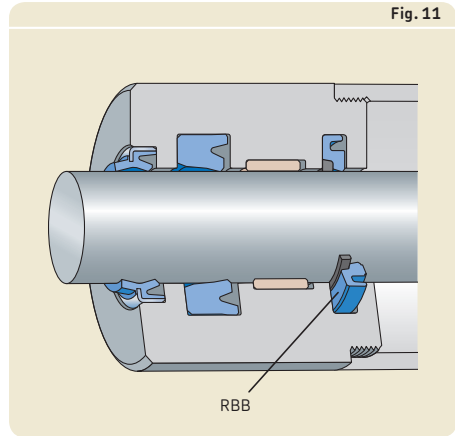
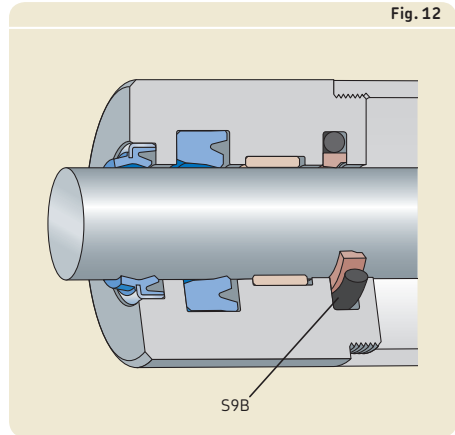

Fig. 12



### RSB profile

RSB profiles (→ **fig. 13**) have a nitrile rubber (NBR) energizer and a PTFE slide ring.

The resilient energizer has protrusions (→ **fig. 14**) on the system side, which are in contact with the buffer groove. This design keeps the slide ring in a permanent sealing position against the rod seal side of the buffer groove. Conventional buffer seal designs can shift axially within the groove and push fluid into the rod seal groove when subjected to abrupt pressure peaks. This ultimately causes rod seal failure. However, the patented design of RSB profiles prevents any axial shifting of the slide ring. Therefore, these profiles protect the rod seal in applications where conventional buffers are not sufficient. In combination with grooves in the energizer outside diameter and notches in the front face of the slide ring, the protrusions also ensure that pressure can return to the system side.

RSB profiles are suitable for pressures up to 400 bar (5 800 psi) in heavy duty applications and are available in inch sizes.

On request, for the most demanding applications of large equipment, SKF can manufacture these profiles with polyamide (PA) slide rings for additional extrusion and wear resistance.

Fig. 13

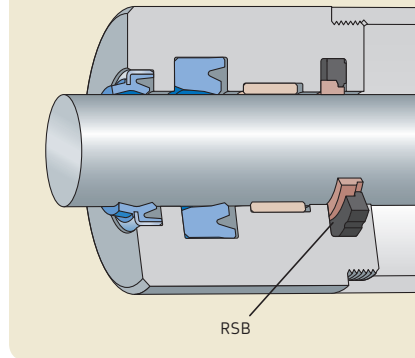
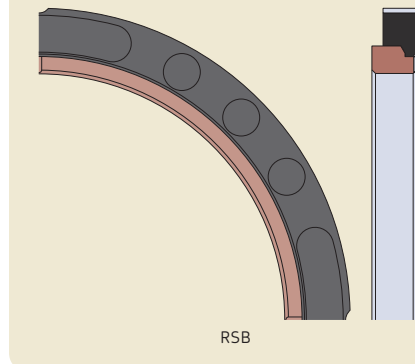

Fig. 14



## S1S profile data



<b>Materials</b>	ECOPUR For additional information → <b>page 26</b>												
<b>Pressure</b>	Up to 400 bar (5 800 psi)												
<b>Speed</b>	Up to 1 m/s (3.2 ft/s)												
<b>Temperature range</b>	<div style="display: flex; align-items: center;"> <table style="margin-left: 10px;"> <tr> <td>-60</td> <td>-40</td> <td>-30</td> <td>110</td> <td>120</td> <td>130 [°C]</td> </tr> <tr> <td>-75</td> <td>-40</td> <td>-20</td> <td>230</td> <td>250</td> <td>265 [°F]</td> </tr> </table> </div> <ul style="list-style-type: none"> <li><span style="display: inline-block; width: 15px; height: 15px; background-color: #0070C0; margin-right: 5px;"></span> Extreme low temperature range: may be intermittently exposed (e.g. cold start-up) without seal damage, but seal performance may be compromised while in this range</li> <li><span style="display: inline-block; width: 15px; height: 15px; background-color: #666666; margin-right: 5px;"></span> Temperatures below the recommended operating range: seal performance depends on system design (precision guiding arrangement recommended)</li> <li><span style="display: inline-block; width: 15px; height: 15px; background-color: #00B050; margin-right: 5px;"></span> <b>Recommended operating temperature range for this profile and material</b></li> <li><span style="display: inline-block; width: 15px; height: 15px; background-color: #FFD700; margin-right: 5px;"></span> Temperatures above the recommended operating range: acceptable only with reduced pressure, speed, e-gap and/or with the use of a full-face anti-extrusion ring</li> <li><span style="display: inline-block; width: 15px; height: 15px; background-color: #FF0000; margin-right: 5px;"></span> Extreme high temperature range: only occasional short term exposure (e.g. cylinder in curing oven of a powder coating process)</li> </ul>	-60	-40	-30	110	120	130 [°C]	-75	-40	-20	230	250	265 [°F]
-60	-40	-30	110	120	130 [°C]								
-75	-40	-20	230	250	265 [°F]								
<b>Dimension standards</b>	Some sizes fit seal housings in accordance with ISO 5597.												
<b>Counter-surface</b>	→ <b>page 22</b>												

Maximum values of application parameters (e.g. pressure, speed, temperature, e-gap) should not be applied continuously nor simultaneously.

### 3.1 S1S profile rod seals, metric sizes d 18 – 110 mm

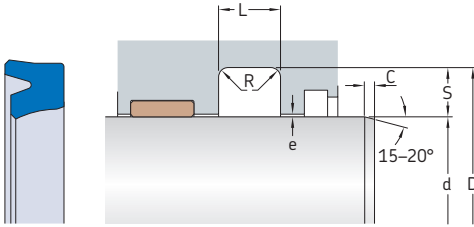

#### Maximum extrusion gap e

Radial depth	$e_{\max}$ at 80 °C (175 °F) for pressures		
	160 bar	250 bar	400 bar
5	160 bar	250 bar	400 bar
mm	mm		
4	0,4	0,3	0,15
5	0,5	0,4	0,2
7,5	0,55	0,45	0,25
10	0,6	0,5	0,3

3.1

#### Cylinder dimensions

#### Designation

d f8	D H10	L +0,2	S	R max.	C min.	
mm						-
18	26	6,3	4	0,4	3,5	• S1S-18x26x6.3
20	28	6,3	4	0,4	3,5	S1S-20x28x6.3
25	33 35	6 8	4 5	0,4 0,4	3,5 4	• S1S-25x33x6 • S1S-25x35x8
28	38	8	5	0,4	4	• S1S-28x38x8
30	40	7	5	0,4	4	S1S-30x40x7
32	42	8	5	0,4	4	• S1S-32x42x8
35	45	7	5	0,4	4	S1S-35x45x7
36	46	8	5	0,4	4	• S1S-36x46x8
40	50	8	5	0,4	4	• S1S-40x50x8
45	55	8	5	0,4	4	• S1S-45x55x8
50	60 65	8 10	5 7,5	0,4 0,4	4 5	S1S-50x60x8 • S1S-50x65x10
55	65 70	10 10	5 7,5	0,4 0,4	4 5	S1S-55x65x10 S1S-55x70x10
63	78	10	7,5	0,4	5	• S1S-63x78x10
75	85	12,4	5	0,4	4	S1S-75x85x12.4
80	95 95	10 12,4	7,5 7,5	0,4 0,4	5 5	• S1S-80x95x10 S1S-80x95x12.4
90	105	10	7,5	0,4	5	• S1S-90x105x10
100	115	10	7,5	0,4	5	• S1S-100x115x10
110	125	10	7,5	0,4	5	• S1S-110x125x10

• Dimensions in accordance with ISO 5597

### 3.1 S1S profile rod seals, metric sizes d 125 – 240 mm

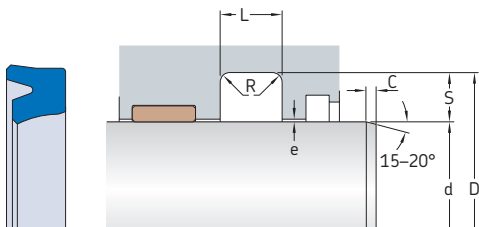

#### Maximum extrusion gap e

Radial depth	$e_{\max}$ at 80 °C (175 °F) for pressures		
	160 bar	250 bar	400 bar
S			
mm	mm		
4	0,4	0,3	0,15
5	0,5	0,4	0,2
7,5	0,55	0,45	0,25
10	0,6	0,5	0,3

#### Cylinder dimensions

#### Designation

d	D	L	S	R	C	Designation
f8	H10	+0,2		max.	min.	
mm						-
125	145	16	10	0,4	6	S1S-125x145x16
140	155	10	7,5	0,4	5	• S1S-140x155x10
160	180	16	10	0,4	6	S1S-160x180x16
180	200	14	10	0,4	6	• S1S-180x200x14
200	220	14	10	0,4	6	• S1S-200x220x14
240	260	16	10	0,4	6	S1S-240x260x16

Other sizes are available on request

• Dimensions in accordance with ISO 5597



## ZBR profile data



<b>Materials</b>	TPU 93A, U-1029 For additional information → <b>page 26</b>														
<b>Pressure</b>	Up to 400 bar (5 800 psi)														
<b>Speed</b>	Up to 1 m/s (3.2 ft/s)														
<b>Temperature range</b>	<div style="display: flex; align-items: center;"> <table style="margin-left: 20px; border-collapse: collapse;"> <tr> <td style="text-align: right;">-60</td> <td style="text-align: center;">-40</td> <td style="text-align: center;">-30</td> <td style="width: 100px;"></td> <td style="text-align: left;">110</td> <td style="text-align: left;">120</td> <td style="text-align: left;">130 [°C]</td> </tr> <tr> <td style="text-align: right;">-75</td> <td style="text-align: center;">-40</td> <td style="text-align: center;">-20</td> <td></td> <td style="text-align: left;">230</td> <td style="text-align: left;">250</td> <td style="text-align: left;">265 [°F]</td> </tr> </table> </div> <ul style="list-style-type: none"> <li><span style="display: inline-block; width: 15px; height: 15px; background-color: #007bff; margin-right: 5px;"></span> Extreme low temperature range: may be intermittently exposed (e.g. cold start-up) without seal damage, but seal performance may be compromised while in this range</li> <li><span style="display: inline-block; width: 15px; height: 15px; background-color: #6c757d; margin-right: 5px;"></span> Temperatures below the recommended operating range: seal performance depends on system design (precision guiding arrangement recommended)</li> <li><span style="display: inline-block; width: 15px; height: 15px; background-color: #28a745; margin-right: 5px;"></span> <b>Recommended operating temperature range for this profile and material</b></li> <li><span style="display: inline-block; width: 15px; height: 15px; background-color: #ffc107; margin-right: 5px;"></span> Temperatures above the recommended operating range: acceptable only with reduced pressure, speed, e-gap and/or with the use of a full-face anti-extrusion ring</li> <li><span style="display: inline-block; width: 15px; height: 15px; background-color: #dc3545; margin-right: 5px;"></span> Extreme high temperature range: only occasional short term exposure (e.g. cylinder in curing oven of a powder coating process)</li> </ul>	-60	-40	-30		110	120	130 [°C]	-75	-40	-20		230	250	265 [°F]
-60	-40	-30		110	120	130 [°C]									
-75	-40	-20		230	250	265 [°F]									
<b>Dimension standards</b>	Some metric sizes fit seal housings in accordance with ISO 5597.														
<b>Counter-surface</b>	→ <b>page 22</b>														

Maximum values of application parameters (e.g. pressure, speed, temperature, e-gap) should not be applied continuously nor simultaneously.



### 3.2 ZBR profile rod seals, metric sizes d 14 – 45 mm

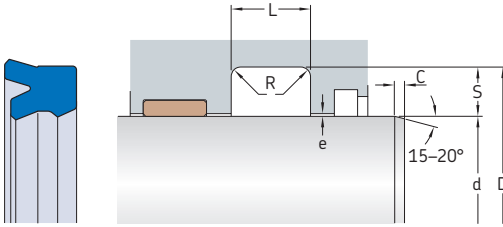

#### Maximum extrusion gap e

Radial depth	$e_{max}$ at 80 °C (175 °F) for pressures		
	160 bar	250 bar	400 bar
5	160 bar	250 bar	400 bar
mm	mm		
3,5 to 4	0,35	0,2	–
5 to 6,5	0,45	0,25	0,1
7 to 7,5	0,5	0,3	0,15
10	0,55	0,3	0,15
12,5	0,6	0,3	0,2

#### Cylinder dimensions

#### Designation

d h9	D H9	L +0,2	S	R max.	C min.	
mm						–
14	22	5,7	4	0,2	6	ZBR-14x22x5.7-E6W
16	24	5,7	4	0,2	6	ZBR-16x24x5.7-E6W
18	26	5,7	4	0,2	6	ZBR-18x26x5.7-E6W
20	28	5,7	4	0,2	6	ZBR-20x28x5.7-E6W
22	30	5,7	4	0,2	6	ZBR-22x30x5.7-E6W
22,4	30	5,7	3,8	0,2	6	ZBR-22.4x30x5.7-E6W
25	33	5,7	4	0,2	6	ZBR-25x33x5.7-E6W
	33	8	4	0,2	6	ZBR-25x33x8-E6W
28	35	5,7	3,5	0,2	6	ZBR-28x35.5x5.7-E6W
	36	6,4	4	0,2	6	ZBR-28x36x6.4-E6W
30	38	7,8	4	0,2	6	ZBR-30x38x7.8-E6W
	40	7	5	0,2	6	ZBR-30x40x7-E6W
32	42	8,3	5	0,2	6	ZBR-32x42x8.3-E6W
	40	6,4	4	0,2	6	ZBR-32x40x6.4-E6W
35	43	7,8	4	0,2	6	ZBR-35x43x7.8-E6W
	45	7	5	0,2	6	ZBR-35x45x7-E6W
	45	11	5	0,2	6	ZBR-35x45x11-E6W
40	50	7	5	0,2	6	ZBR-40x50x7-E6W
	55	11	7,5	0,5	8,5	ZBR-40x55x11-E6W
	50	7	5	0,2	6	ZBR-40x50x7-E6W
	50	11	5	0,2	6	ZBR-40x50x11-E6W
	55	12	7,5	0,5	8,5	ZBR-40x55x12-E6W
45	60	11	7,5	0,5	8,5	ZBR-45x60x11-E6W
	55	7	5	0,2	6	ZBR-45x55x7-E6W
	55	8,3	5	0,2	6	ZBR-45x55x8.3-E6W
	55	11	5	0,2	6	ZBR-45x55x11-E6W
	60	12	7,5	0,5	8,5	ZBR-45x60x12-E6W
	60	12,5	7,5	0,2	8,5	• ZBR-45x60x12.5-E6W

• Dimensions in accordance with ISO 5597

### 3.2 ZBR profile rod seals, metric sizes d 50 – 150 mm

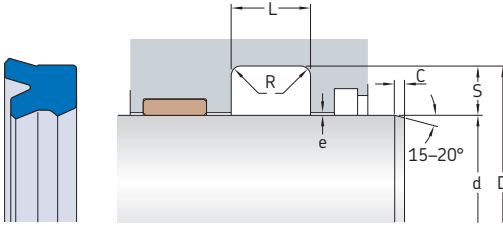

#### Maximum extrusion gap e

Radial depth	$e_{max}$ at 80 °C (175 °F) for pressures		
	160 bar	250 bar	400 bar
5			
mm	mm		
3,5 to 4	0,35	0,2	–
5 to 6,5	0,45	0,25	0,1
7 to 7,5	0,5	0,3	0,15
10	0,55	0,3	0,15
12,5	0,6	0,3	0,2

#### Cylinder dimensions

#### Designation

d h9	D H9	L +0,2	S	R max.	C min.	
mm						–
50	65	11	7,5	0,5	8,5	ZBR-50x65x11-E6W
	65	12,4	7,5	0,5	8,5	ZBR-50x65x12.4-E6W
	61	7	5	0,2	6	ZBR-50x60x7-E6W
	62	8,3	5	0,2	6	ZBR-50x60x8.3-E6W
	63	8,5	5	0,2	6	ZBR-50x60x8.5-E6W
53	63	7	5	0,2	6	ZBR-53x63x7-E6W
55	65	7	5	0,2	6	ZBR-55x65x7-E6W
	65	9	5	0,2	6	ZBR-55x65x9-E6W
	65	11	5	0,2	6	ZBR-55x65x11-E6W
	68	11	6,5	0,2	7,5	ZBR-55x68x11-E6W
	70	10	7,5	0,5	8,5	ZBR-55x70x10-E6W
	70	11	7,5	0,5	8,5	ZBR-55x70x11-E6W
	70	12,4	7,5	0,2	8,5	ZBR-55x70x12.4-E6W
	75	13	10	0,8	6	ZBR-55x75x13-E6W
56	71	12,4	7,5	0,5	8,5	• ZBR-56x71x12.4-E6W
60	68	9	4	0,2	6	ZBR-60x68x9-E6W
	70	7	5	0,2	6	ZBR-60x70x7-E6W
	70	11	5	0,2	6	ZBR-60x70x11-E6W
	73	11	6,5	0,2	7,5	ZBR-60x73x11-E6W
	75	10	7,5	0,5	8,5	ZBR-60x75x10-E6W
	80	13	10	0,8	11	ZBR-60x80x13-E6W
63	73	7	5	0,2	6	ZBR-63x73x7-E6W
	78	12,4	7,5	0,5	8,5	ZBR-63x78x12.4-E6W
	78	13,5	7,5	0,5	6	ZBR-63x78x13.5-E6W
65	75	7	5	0,2	6	ZBR-65x75x7-E6W
	78	11	6,5	0,2	7,5	ZBR-65x78x11-E6W
	80	10	7,5	0,5	8,5	ZBR-65x80x10-E6W
	80	13	7,5	0,5	8,5	ZBR-65x80x13-E6W
	85	13	10	0,8	11	ZBR-65x85x13-E6W

• Dimensions in accordance with ISO 5597

Cylinder dimensions						Designation
d h9	D H9	L +0,2	S	R max.	C min.	
mm						-
70	80	7	5	0,2	6	ZBR-70x80x7-E6W
	83	11	6,5	0,2	7,5	ZBR-70x83x11-E6W
	85	10	7,5	0,5	8,5	ZBR-70x85x10-E6W
	85	11	7,5	0,5	8,5	ZBR-70x85x11-E6W
	85	12,4	7,5	0,5	8,5	• ZBR-70x85x12.4-E6W
	90	13	10	0,8	11	ZBR-70x90x13-E6W
75	85	7	5	0,2	6	ZBR-75x85x7-E6W
	88	11	6,5	0,2	7,5	ZBR-75x88x11-E6W
	90	10	7,5	0,5	8,5	ZBR-75x90x10-E6W
	90	11	7,5	0,5	8,5	ZBR-75x90x11-E6W
	95	13	10	0,8	11	ZBR-75x95x13-E6W
80	90	7	5	0,2	6	ZBR-80x90x7-E6W
	93	11	6,5	0,2	7,5	ZBR-80x93x11-E6W
	95	10	7,5	0,5	8,5	ZBR-80x95x10-E6W
	95	12,4	7,5	0,5	8,5	• ZBR-80x95x12.4-E6W
	100	13	10	0,8	11	ZBR-80x100x13-E6W
85	100	10	7,5	0,5	8,5	ZBR-85x100x10-E6W
	100	11	7,5	0,5	8,5	ZBR-85x100x11-E6W
	100	13	7,5	0,5	8,5	ZBR-85x100x13-E6W
	105	13	10	0,8	11	ZBR-85x105x13-E6W
90	105	11	7,5	0,5	8,5	ZBR-90x105x11-E6W
	105	12,4	7,5	0,5	8,5	• ZBR-90x105x12.4-E6W
	110	13	10	0,8	11	ZBR-90x110x13-E6W
95	110	10	7,5	0,5	8,5	ZBR-95x110x10-E6W
	110	11	7,5	0,5	8,5	ZBR-95x110x11-E6W
	115	13	10	0,8	11	ZBR-95x115x13-E6W
100	112	15	6	0,2	7	ZBR-100x112x15-E6W
	115	10	7,5	0,5	8,5	ZBR-100x115x10-E6W
	115	11	7,5	0,5	8,5	ZBR-100x115x11-E6W
	115	12,5	7,5	0,5	8,5	ZBR-100x115x12.5-E6W
	120	13	10	0,8	11	ZBR-100x120x13-E6W
	120	15,5	10	0,8	11	ZBR-100x120x15.5-E6W
105	120	10	7,5	0,5	8,5	ZBR-105x120x10-E6W
	125	16,5	10	0,8	11	ZBR-105x125x16.5-E6W
110	125	11	7,5	0,5	8,5	ZBR-110x125x11-E6W
	130	16,5	10	0,8	11	ZBR-110x130x16.5-E6W
112	125	10	6,5	0,2	7,5	ZBR-112x125x10-E6W
118	133	10	7,5	0,5	8,5	ZBR-118x133x10-E6W
120	140	16,5	10	0,8	11	ZBR-120x140x16.5-E6W
125	140	10	7,5	0,5	8,5	ZBR-125x140x10-E6W
	145	16,5	10	0,8	11	ZBR-125x145x16.5-E6W
130	145	12	7,5	0,5	8,5	ZBR-130x145x12-E6W
	150	16,5	10	0,2	11	ZBR-130x150x16.5-E6W
136	150	10	7	0,5	8,5	ZBR-136x150x10-E6W
140	155	10	7,5	0,5	8,5	ZBR-140x155x10-E6W
	160	16,5	10	0,8	11	ZBR-140x160x16.5-E6W
145	160	10	7,5	0,5	8,5	ZBR-145x160x10-E6W
150	170	16,5	10	0,8	11	ZBR-150x170x16.5-E6W

• Dimensions in accordance with ISO 5597

### 3.2 ZBR profile rod seals, metric sizes d 160 – 255 mm

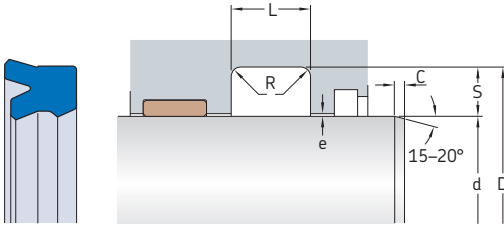

#### Maximum extrusion gap e

Radial depth	$e_{max}$ at 80 °C (175 °F) for pressures		
	160 bar	250 bar	350 bar
S			
mm	mm		
3,5 to 4	0,35	0,2	–
5 to 6,5	0,45	0,25	0,1
7 to 7,5	0,5	0,3	0,15
10	0,55	0,3	0,15
12,5	0,6	0,3	0,2

#### Cylinder dimensions

#### Designation

d h9	D H9	L +0,2	S	R max.	C min.	
mm						–
160	180 185	16,5 19,7	10 12,5	0,8 0,8	11 13	ZBR-160x180x16.5-E6W ZBR-160x185x19.7-E6W
180	200	13,5	10	0,8	11	ZBR-180x200x13.5-E6W
200	220	13,5	10	0,8	11	ZBR-200x220x13.5-E6W
230	250	13,5	10	0,8	11	ZBR-230x250x13.5-E6W
240	260	16,5	10	0,8	11	ZBR-240x260x16.5-E6W
255	280	20,5	12,5	0,8	13	ZBR-255x280x20.5-E6W

Other sizes are available on request

### 3.2 ZBR profile rod seals, inch sizes d 0.75 – 3 in.

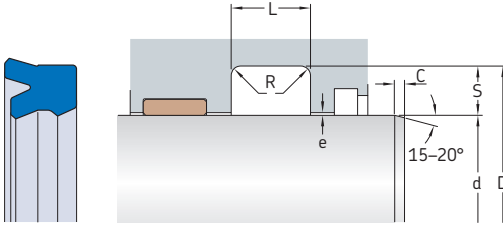

#### Maximum extrusion gap e

Radial depth	$e_{\max}$ at 80 °C (175 °F) for pressures		
	2 300 psi	3 600 psi	5 800 psi
S	in.		
in.	in.		
<b>0.125</b>	0.008	0.004	–
<b>0.187</b>	0.014	0.008	–
<b>0.250</b>	0.018	0.01	0.004
<b>0.312</b>	0.020	0.012	0.006
<b>0.375</b>	0.020	0.012	0.006
<b>0.5</b>	0.024	0.012	0.008

#### Cylinder dimensions

#### Designation

d	Tolerance	D	Tolerance	L	S	R	C	Designation
				+0.010		max.	min.	
in.								–
<b>0.75</b>	–0.001	1	+0.002	0.275	0.125	0.015	0.25	<b>ZBR125-750-250-E6W</b>
<b>1</b>	–0.001	1.25	+0.002	0.275	0.125	0.015	0.25	<b>ZBR125-1000-250-E6W</b>
<b>1.125</b>	–0.001	1.375	+0.002	0.213	0.125	0.015	0.25	<b>ZBR125-1125-187-E6W</b>
	–0.001	1.375	+0.002	0.275	0.125	0.015	0.25	<b>ZBR125-1125-250-E6W</b>
	–0.002	1.5	+0.002	0.343	0.187	0.015	0.25	<b>ZBR187-1125-312-E6W</b>
<b>1.25</b>	–0.001	1.5	+0.002	0.213	0.125	0.015	0.25	<b>ZBR125-1250-187-E6W</b>
	–0.001	1.5	+0.002	0.223	0.125	0.015	0.25	<b>ZBR125-1250-197-E6W</b>
	–0.001	1.5	+0.002	0.275	0.125	0.015	0.25	<b>ZBR125-1250-250-E6W</b>
	–0.002	1.625	+0.002	0.275	0.187	0.015	0.25	<b>ZBR187-1250-250-E6W</b>
	–0.002	1.625	+0.002	0.343	0.187	0.015	0.25	<b>ZBR187-1250-312-E6W</b>
<b>1.375</b>	–0.001	1.625	+0.002	0.275	0.125	0.015	0.25	<b>ZBR125-1375-250-E6W</b>
<b>1.5</b>	–0.001	1.75	+0.002	0.275	0.125	0.015	0.25	<b>ZBR125-1500-250-E6W</b>
	–0.002	1.875	+0.002	0.343	0.187	0.015	0.25	<b>ZBR187-1500-312-E6W</b>
	–0.002	1.875	+0.002	0.413	0.187	0.015	0.25	<b>ZBR187-1500-375-E6W</b>
	–0.002	2	+0.003	0.413	0.250	0.02	0.312	<b>ZBR250-1500-375-E6W</b>
<b>1.75</b>	–0.002	2.125	+0.002	0.343	0.187	0.015	0.25	<b>ZBR187-1750-312-E6W</b>
	–0.002	2.125	+0.002	0.413	0.187	0.015	0.25	<b>ZBR187-1750-375-E6W</b>
	–0.002	2.25	+0.003	0.413	0.250	0.02	0.312	<b>ZBR250-1750-375-E6W</b>
<b>1.875</b>	–0.002	2.375	+0.003	0.413	0.250	0.02	0.312	<b>ZBR250-1875-375-E6W</b>
<b>2</b>	–0.002	2.375	+0.002	0.343	0.187	0.015	0.25	<b>ZBR187-2000-312-E6W</b>
	–0.002	2.375	+0.002	0.413	0.187	0.015	0.25	<b>ZBR187-2000-375-E6W</b>
	–0.002	2.5	+0.003	0.413	0.250	0.02	0.312	<b>ZBR250-2000-375-E6W</b>
<b>2.25</b>	–0.002	2.625	+0.002	0.3685	0.187	0.015	0.25	<b>ZBR187-2250-335-E6W</b>
	–0.002	2.75	+0.003	0.413	0.250	0.02	0.312	<b>ZBR250-2250-375-E6W</b>
<b>2.5</b>	–0.002	3	+0.003	0.413	0.250	0.02	0.312	<b>ZBR250-2500-375-E6W</b>
<b>2.625</b>	–0.002	3.125	+0.003	0.413	0.250	0.02	0.312	<b>ZBR250-2625-375-E6W</b>
<b>2.875</b>	–0.002	3.375	+0.003	0.413	0.250	0.02	0.312	<b>ZBR250-2875-375-E6W</b>
<b>3</b>	–0.002	3.5	+0.003	0.413	0.250	0.02	0.312	<b>ZBR250-3000-375-E6W</b>

### 3.2 ZBR profile rod seals, inch sizes d 3.25 – 8 in.

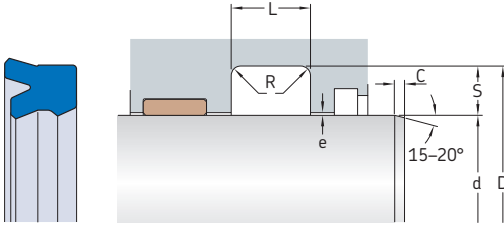

#### Maximum extrusion gap e

Radial depth	$e_{\max}$ at 80 °C (175 °F) for pressures		
	2 300 psi	3 600 psi	5 800 psi
S			
in.	in.		
<b>0.125</b>	0.008	0.004	–
<b>0.187</b>	0.014	0.008	–
<b>0.250</b>	0.018	0.01	0.004
<b>0.312</b>	0.020	0.012	0.006
<b>0.375</b>	0.020	0.012	0.006
<b>0.5</b>	0.024	0.012	0.008

#### Cylinder dimensions

#### Designation

d	Tolerance	D	Tolerance	L +0.010	S	R max.	C min.	Designation
in.								–
3.25	–0.002	3.75	+0.003	0.413	0.250	0.02	0.312	ZBR250-3250-375-E6W
3.5	–0.002	4	+0.003	0.413	0.250	0.02	0.312	ZBR250-3500-375-E6W
3.75	–0.002	4.375	+0.004	0.55	0.312	0.02	0.375	ZBR312-3750-500-E6W
4	–0.002	4.5	+0.003	0.413	0.250	0.02	0.312	ZBR250-4000-375-E6W
4.75	–0.002	5.25	+0.003	0.688	0.250	0.02	0.312	ZBR250-4750-625-E6W
5	–0.002	5.5	+0.003	0.413	0.250	0.02	0.312	ZBR250-5000-375-E6W
	–0.002	5.5	+0.003	0.618	0.250	0.02	0.312	ZBR250-5000-562-E6W
5.25	–0.002	5.75	+0.003	0.618	0.250	0.02	0.312	ZBR250-5250-562-E6W
5.5	–0.002	6	+0.003	0.618	0.250	0.02	0.312	ZBR250-5500-562-E6W
	–0.002	6.25	+0.005	0.688	0.375	0.035	0.5	ZBR375-5500-625-E6W
6.5	–0.002	7.25	+0.005	0.688	0.375	0.035	0.5	ZBR375-6500-625-E6W
	–0.003	7.5	+0.007	0.825	0.500	0.035	0.625	ZBR500-6500-750E6W
7	–0.003	8	+0.007	0.825	0.500	0.035	0.625	ZBR500-7000-750E6W
7.75	–0.002	8.5	+0.005	0.688	0.375	0.035	0.5	ZBR375-7750-625-E6W
8	–0.002	8.75	+0.005	0.688	0.375	0.035	0.5	ZBR375-8000-625-E6W

Other sizes are available on request



## SIL profile data



<b>Materials</b>	TPU B93 For additional information → <b>page 26</b>
<b>Pressure</b>	Up to 350 bar (5 075 psi)
<b>Speed</b>	Up to 0,5 m/s (1.6 ft/s)
<b>Temperature range</b>	<p>             -60 -50 -40 100 110 [°C]              -75 -60 -40 210 230 [°F]         </p> <ul style="list-style-type: none"> <li><span style="color: blue;">■</span> Extreme low temperature range: may be intermittently exposed (e.g. cold start-up) without seal damage, but seal performance may be compromised while in this range</li> <li><span style="color: grey;">■</span> Temperatures below the recommended operating range: seal performance depends on system design (precision guiding arrangement recommended)</li> <li><span style="color: green;">■</span> <b>Recommended operating temperature range for this profile and material</b></li> <li><span style="color: red;">■</span> Extreme high temperature range: only occasional short term exposure (e.g. cylinder in curing oven of a powder coating process)</li> </ul>
<b>Dimension standards</b>	Some sizes fit seal grooves in accordance with ISO 5597.
<b>Counter-surface</b>	→ <b>page 22</b>

Maximum values of application parameters (e.g. pressure, speed, temperature, e-gap) should not be applied continuously nor simultaneously.



### 3.3 SIL profile rod seals, metric sizes d 10 – 30 mm

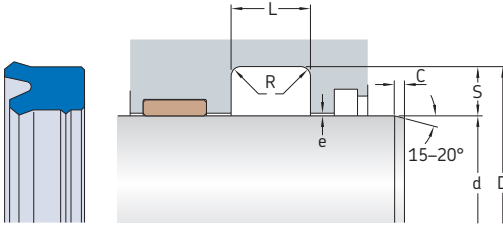

#### Maximum extrusion gap e

Radial depth mm	$e_{max}$ at 60 °C (140 °F) for pressures		
	160 bar	250 bar	350 bar
3	0,2	0,1	–
4	0,35	0,2	–
5	0,45	0,25	0,1
7,5	0,5	0,3	0,15
10	0,55	0,3	0,15

#### Cylinder dimensions

#### Designation

d h9	D H9	L +0,2	S	R max.	C min.	
mm						–
10	18	6,3	4	0,3	2	• SIL 10x18x6.3
12	20 22	6,3 8	4 5	0,3 0,3	2 2,5	• SIL 12x20x6.3 • SIL 12x22x8
14	22 24	6,3 8	4 5	0,3 0,3	2 2,5	• SIL 14x22x6.3 • SIL 14x24x8
16	22 24 24	6 6,3 7	3 4 4	0,3 0,3 0,3	2 2 2	SIL 16x22x6 • SIL 16x24x6.3 SIL 16x24x7
18	24 26	5,2 6,3	3 4	0,3 0,3	2 2	SIL 18x24x5.2 • SIL 18x26x6.3
20	26 28 30 30	5,5 6,3 8 9	3 4 5 5	0,3 0,3 0,3 0,3	2 2 2,5 2,5	SIL 20x26x5.5 • SIL 20x28x6.3 • SIL 20x30x8 SIL 20x30x9
22	30 32	6,3 8	4 5	0,3 0,3	2 2,5	• SIL 22x30x6.3 • SIL 22x32x8
25	33 33 33 35 35 35	6,3 7 11 8 9 11	4 4 4 5 5 5	0,3 0,3 0,3 0,3 0,3 0,3	2 2 2 2,5 2,5 2,5	• SIL 25x33x6.3 SIL 25x33x7 SIL 25x33x11 • SIL 25x35x8 • SIL 25x35x9 SIL 25x35x11
28	38 38 43	8 9 12,5	5 5 7,5	0,3 0,3 0,4	2,5 2,5 4	• SIL 28x38x8 SIL 28x38x9 • SIL 28x43x12.5
30	38 40 40 45	6,3 8 11 11	4 5 5 7,5	0,3 0,3 0,3 0,4	2 2,5 2,5 4	SIL 30x38x6.3 SIL 30x40x8 SIL 30x40x11 SIL 30x45x11

• Seal housing dimensions in accordance with ISO 5597

### 3.3 SIL profile rod seals, metric sizes

d 32 – 150 mm

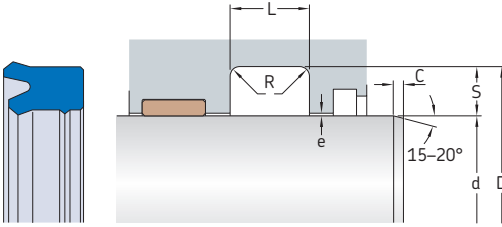

#### Maximum extrusion gap e

Radial depth	$e_{max}$ at 60 °C (140 °F) for pressures		
	160 bar	250 bar	350 bar
5	160 bar	250 bar	350 bar
mm	mm		
3	0,2	0,1	–
4	0,35	0,2	–
5	0,45	0,25	0,1
7,5	0,5	0,3	0,15
10	0,55	0,3	0,15

#### Cylinder dimensions

#### Designation

d	D	L	S	R	C	Designation
h9	H9	+0,2		max.	min.	
mm						–
32	40	6,3	4	0,3	2	SIL 32x40x6.3
	40	9	4	0,3	2	SIL 32x40x9
	42	8	5	0,3	2,5	• SIL 32x42x8
	42	11	5	0,3	2,5	SIL 32x42x11
	47	12,5	7,5	0,4	4	• SIL 32x47x12.5
33	43	11	5	0,3	2,5	SIL 33x43x11
35	43	6,3	4	0,3	2	SIL 35x43x6.3
	45	8	5	0,3	2,5	SIL 35x45x8
	45	11	5	0,3	2,5	SIL 35x45x11
	50	11	7,5	0,4	4	SIL 35x50x11
36	46	8	5	0,3	2,5	• SIL 36x46x8
	51	12,5	7,5	0,4	4	• SIL 36x51x12.5
40	50	8	5	0,3	2,5	• SIL 40x50x8
	50	11	5	0,3	2,5	SIL 40x50x11
	55	11	7,5	0,4	4	SIL 40x55x11
	55	12,5	7,5	0,4	4	• SIL 40x55x12.5
	60	13	5	0,6	5	SIL 40x60x13
42	52	11	5	0,3	2,5	SIL 42x52x11
45	55	8	5	0,3	2,5	• SIL 45x55x8
	55	11	5	0,3	2,5	SIL 45x55x11
	60	11	7,5	0,4	4	SIL 45x60x11
	60	12,5	7,5	0,4	4	• SIL 45x60x12.5
46	56	11	5	0,3	2,5	SIL 46x56x11
50	60	8	5	0,3	2,5	• SIL 50x60x8
	60	11	5	0,3	2,5	SIL 50x60x11
	65	11	7,5	0,4	4	SIL 50x65x11
	65	12,5	7,5	0,4	4	• SIL 50x65x12.5
55	65	11	5	0,3	2,5	SIL 55x65x11
	70	12,5	7,5	0,4	4	SIL 55x70x12.5

• Seal housing dimensions in accordance with ISO 5597

Cylinder dimensions						Designation
d h9	D H9	L +0,2	S	R max.	C min.	
mm						-
56	66	11	5	0,3	2,5	SIL 56x66x11
	71	11	7,5	0,4	4	SIL 56x71x11
	71	12,5	7,5	0,4	4	• SIL 56x71x12,5
	76	16	10	0,6	5	• SIL 56x76x16
60	70	11	5	0,3	2,5	SIL 60x70x11
	70	13	5	0,3	2,5	SIL 60x70x13
	75	11	7,5	0,4	4	SIL 60x75x11
	75	13	7,5	0,4	4	SIL 60x75x13
63	73	13	5	0,3	2,5	SIL 63x73x13
	78	11	7,5	0,4	4	SIL 63x78x11
	78	12,5	7,5	0,4	4	• SIL 63x78x12,5
	83	13	10	0,6	5	SIL 63x83x13
	83	16	10	0,6	5	• SIL 63x83x16
65	75	13	5	0,3	2,5	SIL 65x75x13
70	80	9	5	0,3	2,5	SIL 70x80x9
	80	12,5	5	0,3	2,5	SIL 70x80x12,5
	85	11	7,5	0,4	4	SIL 70x85x11
	85	12,5	7,5	0,4	4	• SIL 70x85x12,5
	90	13	10	0,6	5	SIL 70x90x13
	90	16	10	0,6	5	• SIL 70x90x16
75	85	12,5	5	0,3	2,5	SIL 75x85x12,5
	90	12,5	7,5	0,4	4	SIL 75x90x12,5
80	90	11	5	0,3	2,5	SIL 80x90x11
	90	13	5	0,3	2,5	SIL 80x90x13
	95	11	7,5	0,4	4	SIL 80x95x11
	95	12,5	7,5	0,4	4	• SIL 80x95x12,5
	100	13	10	0,6	5	SIL 80x100x13
	100	16	10	0,6	5	• SIL 80x100x16
85	100	12,5	7,5	0,4	4	SIL 85x100x12,5
	105	13	10	0,6	5	SIL 85x105x13
90	105	12,5	7,5	0,4	4	• SIL 90x105x12,5
	110	13	10	0,6	5	SIL 90x110x13
	110	16	10	0,6	5	• SIL 90x110x16
95	110	12,5	7,5	0,4	4	SIL 95x110x12,5
	115	13	10	0,6	5	SIL 95x115x13
100	115	13	7,5	0,4	4	SIL 100x115x13
	120	13	10	0,6	5	SIL 100x120x13
	120	16	10	0,6	5	• SIL 100x120x16
105	115	11	5	0,3	2,5	SIL 105x115x11
	125	13	10	0,6	5	SIL 105x125x13
110	130	16	10	0,6	5	• SIL 110x130x16
120	140	13	10	0,6	5	SIL 120x140x13
	140	16	10	0,6	5	SIL 120x140x16
125	145	13	10	0,6	5	SIL 125x145x13
	145	16	10	0,6	5	• SIL 125x145x16
130	150	16	10	0,6	5	SIL 130x150x16
140	160	16	10	0,6	5	• SIL 140x160x16
	170	13	10	0,6	5	SIL 150x170x13
150	170	16	10	0,6	5	SIL 150x170x16

Other sizes are available on request

• Seal housing dimensions in accordance with ISO 5597

## PTB profile data



<b>Materials</b>	Sealing ring: TPU 95A, U-1003 X-ring: NBR 70A, A-8501 For additional information → <b>page 26</b>
<b>Pressure</b>	Up to 400 bar (5 800 psi)
<b>Speed</b>	Up to 1 m/s (3.2 ft/s)
<b>Temperature range</b>	<div style="display: flex; align-items: center;"> <div style="margin-right: 10px;"> <p>-50   -40   -30</p> <p>-60   -40   -20</p> </div> <div style="margin-left: 10px;"> <p>100   110   120 [°C]</p> <p>210   230   250 [°F]</p> </div> </div> <ul style="list-style-type: none"> <li><span style="display: inline-block; width: 15px; height: 15px; background-color: #007bff; margin-right: 5px;"></span> Extreme low temperature range: may be intermittently exposed (e.g. cold start-up) without seal damage, but seal performance may be compromised while in this range</li> <li><span style="display: inline-block; width: 15px; height: 15px; background-color: #6c757d; margin-right: 5px;"></span> Temperatures below the recommended operating range: seal performance depends on system design (precision guiding arrangement recommended)</li> <li><span style="display: inline-block; width: 15px; height: 15px; background-color: #28a745; margin-right: 5px;"></span> <b>Recommended operating temperature range for this profile and material</b></li> <li><span style="display: inline-block; width: 15px; height: 15px; background-color: #ffc107; margin-right: 5px;"></span> Temperatures above the recommended operating range: acceptable only with reduced pressure, speed, e-gap and/or with the use of a full-face anti-extrusion ring</li> <li><span style="display: inline-block; width: 15px; height: 15px; background-color: #dc3545; margin-right: 5px;"></span> Extreme high temperature range: only occasional short term exposure (e.g. cylinder in curing oven of a powder coating process)</li> </ul>
<b>Dimension standards</b>	Some metric sizes fit seal housings in accordance with ISO 5597.
<b>Counter-surface</b>	→ <b>page 22</b>

Maximum values of application parameters (e.g. pressure, speed, temperature, e-gap) should not be applied continuously nor simultaneously.

### 3.4 PTB profile rod seals, metric sizes d 8–17 mm

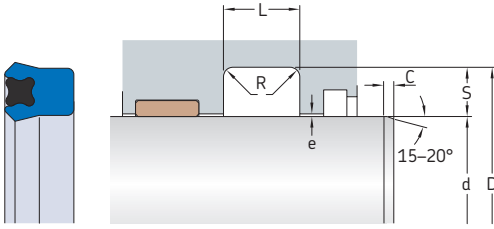

#### Maximum extrusion gap e

Radial depth S	$e_{max}$ at 60 °C (140 °F) for pressures		
	160 bar	250 bar	400 bar
mm	mm		
3	0,2	0,1	–
3,5 to 4	0,35	0,2	–
4,5 to 6,5	0,45	0,25	0,1
7 to 8	0,5	0,3	0,15
9 to 11,5	0,55	0,3	0,15
12,5	0,6	0,3	0,2
15	0,6	0,3	0,2

#### Cylinder dimensions

#### Designation

d h9	D H9	L +0,2	S	R max.	C min.	Designation
mm						–
8	16	6,3	4	0,2	6	• PTB-8x16x6.3-J1S
9	17	6,3	4	0,2	6	PTB-9x17x6.3-J1S
	19	8,8	5	0,2	6	PTB-9x19x8.8-J1S
10	16	6,6	3	0,2	6	PTB-10x16x6.6-J1S
	18	6,3	4	0,2	6	• PTB-10x18x6.3-J1S
	18	8,8	4	0,2	6	PTB-10x18x8.8-J1S
	20	8,3	5	0,2	6	PTB-10x20x8.3-J1S
	20	8,8	5	0,2	6	PTB-10x20x8.8-J1S
11,2	19,2	5,5	4	0,2	6	PTB-11.2x19.2x5.5-J1S
12	18	6,6	3	0,2	6	PTB-12x18x6.6-J1S
	19	5,1	3,5	0,2	6	PTB-12x19x5.1-J1S
	20	5,5	4	0,2	6	PTB-12x20x5.5-J1S
	20	7	4	0,2	6	PTB-12x20x7-J1S
	22	6,6	5	0,2	6	PTB-12x22x6.6-J1S
	22	8	5	0,2	6	• PTB-12x22x8-J1S
	22	8,8	5	0,2	6	PTB-12x22x8.8-J1S
12,5	22,5	8,8	5	0,2	6	PTB-12.5x22.5x8.8-J1S
13	19	4,4	3	0,2	6	PTB-13x19x4.4-J1S
14	21	5,1	3,5	0,2	6	PTB-14x21x5.1-J1S
	22	5,5	4	0,2	6	PTB-14x22x5.5-J1S
	24	6,1	5	0,2	6	PTB-14x24x6.1-J1S
	24	8,8	5	0,2	6	PTB-14x24x8.8-J1S
15	22	5,5	3,5	0,2	6	PTB-15x22x5.5-J1S
	25	8,8	5	0,2	6	PTB-15x25x8.8-J1S
16	22	4,4	3	0,2	6	PTB-16x22x4.4-J1S
	24	5,5	4	0,2	6	PTB-16x24x5.5-J1S
	26	8,8	5	0,2	6	PTB-16x26x8.8-J1S
17	25	11	4	0,2	6	PTB-17x25x11-J1S

• Dimensions in accordance with ISO 5597

### 3.4 PTB profile rod seals, metric sizes d 18 – 35 mm

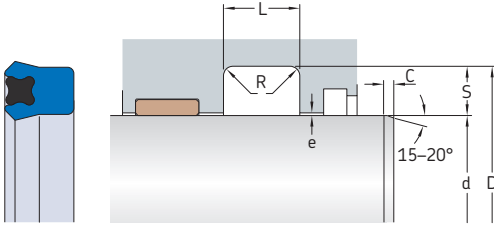

#### Maximum extrusion gap e

Radial depth S	e <sub>max</sub> at 60 °C (140 °F) for pressures		
	160 bar	250 bar	400 bar
mm	mm		
3	0,2	0,1	–
3,5 to 4	0,35	0,2	–
4,5 to 6,5	0,45	0,25	0,1
7 to 8	0,5	0,3	0,15
9 to 11,5	0,55	0,3	0,15
12,5	0,6	0,3	0,2
15	0,6	0,3	0,2

#### Cylinder dimensions

#### Designation

d h9	D H9	L +0,2	S	R max.	C min.	
mm						–
18	25	5,1	3,5	0,2	6	PTB-18x25x5.1-J1S
	26	5,5	4	0,2	6	PTB-18x26x5.5-J1S
	28	8,8	5	0,2	6	PTB-18x28x8.8-J1S
20	26	5,5	3	0,2	6	PTB-20x26x5.5-J1S
	27	6,6	3,5	0,2	6	PTB-20x27x6.6-J1S
	28	5,5	4	0,2	6	PTB-20x28x5.5-J1S
	28	6,3	4	0,2	6	• PTB-20x28x6.3-J1S
	28	7,9	4	0,2	6	PTB-20x28x7.9-J1S
	30	6,6	5	0,2	6	PTB-20x30x6.6-J1S
	30	7,9	5	0,2	6	PTB-20x30x7.9-J1S
	30	8,8	5	0,2	6	PTB-20x30x8.8-J1S
	32	6,6	6	0,2	7	PTB-20x32x6.6-J1S
	32	8,8	6	0,2	7	PTB-20x32x8.8-J1S
	35	11	7,5	0,5	8,5	PTB-20x35x11-J1S
	35	3,2	7,5	0,5	8,5	PTB-20x35x13.2-J1S
40	3,2	10	0,8	11	PTB-20x40x13.2-J1S	
22	29	5,1	3,5	0,2	6	PTB-22x29x5.1-J1S
	30	5,5	4	0,2	6	PTB-22x30x5.5-J1S
	30	6,3	4	0,2	6	• PTB-22x30x6.3-J1S
	30	6,6	4	0,2	6	PTB-22x30x6.6-J1S
	30	7,7	4	0,2	6	PTB-22x30x7.7-J1S
	30	8,8	4	0,2	6	PTB-22x30x8.8-J1S
	32	6,6	5	0,2	6	PTB-22x32x6.6-J1S
	32	8	5	0,2	6	• PTB-22x32x8-J1S
	32	8,8	5	0,2	6	PTB-22x32x8.8-J1S
	35	8,8	6,5	0,2	7,5	PTB-22x35x8.8-J1S
	35	11	6,5	0,2	7,5	PTB-22x35x11-J1S
	40	3,2	9	0,8	11	PTB-22x40x13.2-J1S
22,4	30	5,5	3,8	0,2	6	PTB-22.4x30x5.5-J1S
	32,4	8,8	5	0,2	6	PTB-22.4x32.4x8.8-J1S
23,5	31,5	5,5	4	0,2	6	PTB-23.5x31.5x5.5-J1S

• Dimensions in accordance with ISO 5597

Cylinder dimensions						Designation	
d h9	D H9	L +0,2	S	R max.	C min.		
mm						-	
25	33	5,5	4	0,2	6	PTB-25x33x5.5-J1S	
	33	6,1	4	0,2	6	PTB-25x33x6.1-J1S	
	33	6,3	4	0,2	6	PTB-25x33x6.3-J1S	
	33	8,8	4	0,2	6	PTB-25x33x8.8-J1S	
	33	11	4	0,2	6	PTB-25x33x11-J1S	
	35	8	5	0,2	6	• PTB-25x35x8-J1S	
	35	8,8	5	0,2	6	PTB-25x35x8.8-J1S	
	35	11	5	0,2	6	PTB-25x35x11-J1S	
	38	8,8	6,5	0,2	7,5	PTB-25x38x8.8-J1S	
	38	11	6,5	0,2	7,5	PTB-25x38x11-J1S	
	40	11	7,5	0,5	8,5	PTB-25x40x11-J1S	
	28	35	5,5	3,5	0,2	6	PTB-28x35.5x5.5-J1S
36		5,8	4	0,2	6	PTB-28x36x5.8-J1S	
36		8,8	4	0,2	6	PTB-28x36x8.8-J1S	
37		8,6	4,5	0,2	6	PTB-28x37.5x8.6-J1S	
38		8	5	0,2	6	• PTB-28x38x8-J1S	
38		8,8	5	0,2	6	PTB-28x38x8.8-J1S	
38		11	5	0,2	6	PTB-28x38x11-J1S	
40		6,6	6	0,2	7	PTB-28x40x6.6-J1S	
40		11	6	0,2	7	PTB-28x40x11-J1S	
43		11,2	7,5	0,5	8,5	PTB-28x43x11.2-J1S	
48		13,2	10	0,8	11	PTB-28x48x13.2-J1S	
30		37	6,6	3,5	0,2	6	PTB-30x37x6.6-J1S
	38	6,3	4	0,2	6	PTB-30x38x6.3-J1S	
	38	6,9	4	0,2	6	PTB-30x38x6.9-J1S	
	38	8,8	4	0,2	6	PTB-30x38x8.8-J1S	
	40	6,6	5	0,2	6	PTB-30x40x6.6-J1S	
	40	7,2	5	0,2	6	PTB-30x40x7.2-J1S	
	40	8	5	0,2	6	PTB-30x40x8-J1S	
	40	11	5	0,2	6	PTB-30x40x11-J1S	
	42	9,9	6	0,2	7	PTB-30x42x9.9-J1S	
	42	11	6	0,2	7	PTB-30x42x11-J1S	
	45	9,9	7,5	0,5	8,5	PTB-30x45x9.9-J1S	
	45	11	7,5	0,5	8,5	PTB-30x45x11-J1S	
50	11	10	0,8	11	PTB-30x50x11-J1S		
31,5	41,5	6,6	5	0,2	6	PTB-31.5x41.5x6.6-J1S	
32	40	6,3	4	0,2	6	PTB-32x40x6.3-J1S	
	40	8,3	4	0,2	6	PTB-32x40x8.3-J1S	
	40	8,8	4	0,2	6	PTB-32x40x8.8-J1S	
	42	8	5	0,2	6	• PTB-32x42x8-J1S	
	42	11	5	0,2	6	PTB-32x42x11-J1S	
	44	6,1	6	0,2	7	PTB-32x44x6.1-J1S	
	44	6,9	6	0,2	7	PTB-32x44x6.9-J1S	
	45	11	6,5	0,2	7,5	PTB-32x45x11-J1S	
	47	11	7,5	0,5	8,5	PTB-32x47x11-J1S	
	48	11	8	0,5	8,5	PTB-32x48x11-J1S	
	33	40	8,8	3,5	0,2	6	PTB-33x40x8.8-J1S
		43	11	5	0,2	6	PTB-33x43x11-J1S
35	43	7	4	0,2	6	PTB-35x43x7-J1S	
	43	8,8	4	0,2	6	PTB-35x43x8.8-J1S	
	45	6,6	5	0,2	6	PTB-35x45x6.6-J1S	
	45	8	5	0,2	6	PTB-35x45x8-J1S	
	45	8,8	5	0,2	6	PTB-35x45x8.8-J1S	
	45	11	5	0,2	6	PTB-35x45x11-J1S	

• Dimensions in accordance with ISO 5597

### 3.4 PTB profile rod seals, metric sizes d 35 – 60 mm

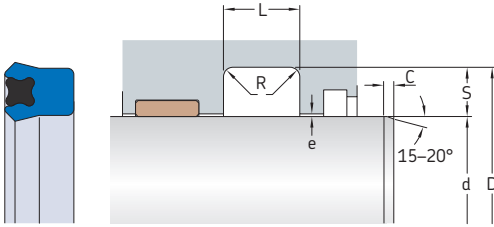

#### Maximum extrusion gap e

Radial depth S	$e_{max}$ at 60 °C (140 °F) for pressures		
	160 bar	250 bar	400 bar
mm	mm		
3	0,2	0,1	–
3,5 to 4	0,35	0,2	–
4,5 to 6,5	0,45	0,25	0,1
7 to 8	0,5	0,3	0,15
9 to 11,5	0,55	0,3	0,15
12,5	0,6	0,3	0,2
15	0,6	0,3	0,2

#### Cylinder dimensions

#### Designation

d h9	D H9	L +0,2	S	R max.	C min.	
mm						–
35	50	9,9	7,5	0,5	8,5	PTB-35x50x9.9-J1S
cont.	50	11	7,5	0,5	8,5	PTB-35x50x11-J1S
	50	2,5	7,5	0,5	8,5	PTB-35x50x12.5-J1S
	51	11	8	0,5	8,5	PTB-35x51x11-J1S
	55	11	10	0,8	11	PTB-35x55x11-J1S
35,5	45	6,6	4,75	0,2	6	PTB-35.5x45x6.6-J1S
36	44	5,8	4	0,2	6	PTB-36x44x5.8-J1S
	44	6,6	4	0,2	6	PTB-36x44x6.6-J1S
	44	8,8	4	0,2	6	PTB-36x44x8.8-J1S
	46	8,8	5	0,2	6	PTB-36x46x8-J1S
	46	11	5	0,2	6	PTB-36x46x11-J1S
	52	11	8	0,5	8,5	PTB-36x52x11-J1S
37	47	8,8	5	0,2	6	PTB-37x47x8.8-J1S
	47	5,5	5	0,2	6	PTB-37x47x5.5-J1S
40	48	5,5	4	0,2	6	PTB-40x48x5.5-J1S
	48	6,6	4	0,2	6	PTB-40x48x6.6-J1S
	48	8,8	4	0,2	6	PTB-40x48x8.8-J1S
	50	6,6	5	0,2	6	PTB-40x50x6.6-J1S
	50	7,2	5	0,2	6	PTB-40x50x7.2-J1S
	50	8	5	0,2	6	• PTB-40x50x8-J1S
	50	8,8	5	0,2	6	PTB-40x50x8.8-J1S
	50	11	5	0,2	6	PTB-40x50x11-J1S
	53	8,8	6,5	0,2	7,5	PTB-40x53x8.8-J1S
	55	9,9	7,5	0,5	8,5	PTB-40x55x9.9-J1S
	55	11	7,5	0,5	8,5	PTB-40x55x11-J1S
	56	11	8	0,5	8,5	PTB-40x56x11-J1S
	60	13,2	10	0,8	11	PTB-40x60x13.2-J1S
41,7	50,7	7,8	4,5	0,2	6	PTB-41.7x50.7x7.8-J1S
42	55	7,7	6,5	0,2	7,5	PTB-42x55x7.7-J1S

• Dimensions in accordance with ISO 5597



Cylinder dimensions						Designation
d h9	D H9	L +0,2	S	R max.	C min.	
mm						-
45	53	5,8	4	0,2	6	PTB-45x53x5.8-J1S
	53	8,8	4	0,2	6	PTB-45x53x8.8-J1S
	55	6,6	5	0,2	6	PTB-45x55x6.6-J1S
	55	8	5	0,2	6	• PTB-45x55x8-J1S
	55	11	5	0,2	6	PTB-45x55x11-J1S
	56	7,7	5,5	0,2	7	PTB-45x56x7.7-J1S
	60	9,9	7,5	0,5	8,5	PTB-45x60x9.9-J1S
	60	11	7,5	0,5	8,5	PTB-45x60x11-J1S
	60	12,7	7,5	0,5	8,5	PTB-45x60x12.7-J1S
	63	13,2	9	0,8	11	PTB-45x63x13.2-J1S
	65	13,2	10	0,8	11	PTB-45x65x13.2-J1S
	70	16,5	12,5	0,8	13	PTB-45x70x16.5-J1S
48	63	11,2	7,5	0,5	8,5	PTB-48x63x11.2-J1S
	68	13,2	10	0,8	11	PTB-48x68x13.2-J1S
50	58	8,8	4	0,2	6	PTB-50x58x8.8-J1S
	60	6,6	5	0,2	6	PTB-50x60x6.6-J1S
	60	8	5	0,2	6	• PTB-50x60x8-J1S
	60	8,8	5	0,2	6	PTB-50x60x8.8-J1S
	60	11	5	0,2	6	PTB-50x60x11-J1S
	60	13,2	5	0,2	6	PTB-50x60x13.2-J1S
	63	8,8	6,5	0,2	7,5	PTB-50x63x8.8-J1S
	63	11	6,5	0,2	7,5	PTB-50x63x11-J1S
	65	9,9	7,5	0,5	8,5	PTB-50x65x9.9-J1S
	65	11	7,5	0,5	8,5	PTB-50x65x11-J1S
	65	12,5	7,5	0,5	8,5	PTB-50x65x12.5-J1S
	70	11	10	0,8	11	PTB-50x70x11-J1S
70	13,2	10	0,8	11	PTB-50x70x13.2-J1S	
53	63	6,6	5	0,2	6	PTB-53x63x6.6-J1S
	63	11	5	0,2	6	PTB-53x63x11-J1S
55	65	6,6	5	0,2	6	PTB-55x65x6.6-J1S
	65	11	5	0,2	6	PTB-55x65x11-J1S
	65	13,2	5	0,2	6	PTB-55x65x13.2-J1S
	68	11	6,5	0,2	7,5	PTB-55x68x11-J1S
	70	9,9	7,5	0,5	8,5	PTB-55x70x9.9-J1S
	70	13,2	7,5	0,5	8,5	PTB-55x70x13.2-J1S
56	66	6,6	5	0,2	6	PTB-56x66x6.6-J1S
	66	11	5	0,2	6	PTB-56x66x11-J1S
	71	2,5	7,5	0,5	8,5	PTB-56x71x12.5-J1S
	70	9,9	6,5	0,2	7,5	PTB-57x70x9.9-J1S
60	68	8,8	4	0,2	6	PTB-60x68x8.8-J1S
	70	6,6	5	0,2	6	PTB-60x70x6.6-J1S
	70	8,8	5	0,2	6	PTB-60x70x8.8-J1S
	70	9,9	5	0,2	6	PTB-60x70x9.9-J1S
	70	11	5	0,2	6	PTB-60x70x11-J1S
	70	13,2	5	0,2	6	PTB-60x70x13.2-J1S

• Dimensions in accordance with ISO 5597

### 3.4 PTB profile rod seals, metric sizes d 60 – 85 mm

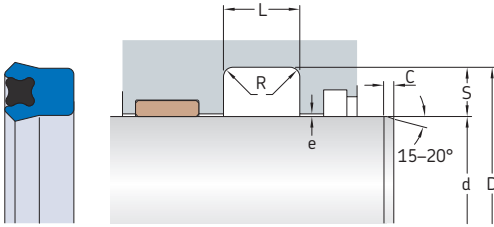

#### Maximum extrusion gap e

Radial depth S	e <sub>max</sub> at 60 °C (140 °F) for pressures		
	160 bar	250 bar	400 bar
mm	mm		
3	0,2	0,1	–
3,5 to 4	0,35	0,2	–
4,5 to 6,5	0,45	0,25	0,1
7 to 8	0,5	0,3	0,15
9 to 11,5	0,55	0,3	0,15
12,5	0,6	0,3	0,2
15	0,6	0,3	0,2

#### Cylinder dimensions

#### Designation

d	D	L	S	R	C	Designation
h9	H9	+0,2		max.	min.	
mm						–
60 cont.	71	7,7	5,5	0,2	7	PTB-60x71x7.7-J1S
	73	11	6,5	0,2	7,5	PTB-60x73x11-J1S
	75	9,9	7,5	0,5	8,5	PTB-60x75x9.9-J1S
	75	11	7,5	0,5	8,5	PTB-60x75x11-J1S
	75	12,1	7,5	0,5	8,5	PTB-60x75x12.1-J1S
80	80	13,2	10	0,8	11	PTB-60x80x13.2-J1S
	80	16	10	0,8	11	PTB-60x80x16-J1S
62	72	13,2	5	0,2	6	PTB-62x72x13.2-J1S
63	71	8,8	4	0,2	6	PTB-63x71x8.8-J1S
	73	6,6	5	0,2	6	PTB-63x73x6.6-J1S
	73	13,2	5	0,2	6	PTB-63x73x13.2-J1S
	75	9,6	6	0,2	7	PTB-63x75x9.6-J1S
	78	9,9	7,5	0,5	8,5	PTB-63x78x9.9-J1S
	78	11	7,5	0,5	8,5	PTB-63x78x11-J1S
64	78	11,7	7,5	0,5	8,5	PTB-63x78x11.7-J1S
	83	13,2	10	0,8	11	PTB-63x83x13.2-J1S
	83	16,5	10	0,8	11	PTB-63x83x16.5-J1S
	80	13,2	8	0,5	8,5	PTB-64x80x13.2-J1S
	65	73	8,8	4	0,2	6
75		6,6	5	0,2	6	PTB-65x75x6.6-J1S
75		8,8	5	0,2	6	PTB-65x75x8.8-J1S
75		11	5	0,2	6	PTB-65x75x11-J1S
75		13,2	5	0,2	6	PTB-65x75x13.2-J1S
78		11	6,5	0,2	7,5	PTB-65x78x11-J1S
80		9,9	7,5	0,5	8,5	PTB-65x80x9.9-J1S
80		11	7,5	0,5	8,5	PTB-65x80x11-J1S
80		13,2	7,5	0,5	8,5	PTB-65x80x13.2-J1S
85		13,2	10	0,8	11	PTB-65x85x13.2-J1S
67	77	6,6	5	0,2	6	PTB-67x77x6.6-J1S

Cylinder dimensions						Designation
d h9	D H9	L +0,2	S	R max.	C min.	
mm						-
70	78	8,8	4	0,2	6	PTB-70x78x8.8-J1S
	80	6,6	5	0,2	6	PTB-70x80x6.6-J1S
	80	11	5	0,2	6	PTB-70x80x11-J1S
	80	13,2	5	0,2	6	PTB-70x80x13.2-J1S
	83	11	6,5	0,2	7,5	PTB-70x83x11-J1S
	85	9,9	7,5	0,5	8,5	PTB-70x85x9.9-J1S
	85	11	7,5	0,5	8,5	PTB-70x85x11-J1S
	85	12,5	7,5	0,5	8,5	• PTB-70x85x12.5-J1S
	85	13,2	7,5	0,5	8,5	PTB-70x85x13.2-J1S
	90	13,2	10	0,8	11	PTB-70x90x13.2-J1S
90	16,5	10	0,8	11	PTB-70x90x16.5-J1S	
71	80	6,6	4,5	0,2	6	PTB-71x80x6.6-J1S
	80	7,2	4,5	0,2	6	PTB-71x80x7.2-J1S
72	82	8,8	5	0,2	6	PTB-72x82x8.8-J1S
	87	9,9	7,5	0,5	8,5	PTB-72x87x9.9-J1S
75	83	6,6	4	0,2	6	PTB-75x83x6.6-J1S
	85	6,6	5	0,2	6	PTB-75x85x6.6-J1S
	85	8,8	5	0,2	6	PTB-75x85x8.8-J1S
	85	11	5	0,2	6	PTB-75x85x11-J1S
	85	13,2	5	0,2	6	PTB-75x85x13.2-J1S
	88	11	6,5	0,2	7,5	PTB-75x88x11-J1S
	90	6,6	7,5	0,5	8,5	PTB-75x90x6.6-J1S
	90	9,9	7,5	0,5	8,5	PTB-75x90x9.9-J1S
	90	11	7,5	0,5	8,5	PTB-75x90x11-J1S
	90	12,1	7,5	0,5	8,5	PTB-75x90x12.1-J1S
90	12,5	7,5	0,5	8,5	PTB-75x90x12.5-J1S	
90	13,2	7,5	0,5	8,5	PTB-75x90x13.2-J1S	
	95	13,2	10	0,8	11	PTB-75x95x13.2-J1S
	100	16,5	12,5	0,8	13	PTB-75x100x16.5-J1S
78	90	12,1	6	0,2	7	PTB-78x90x12.1-J1S
80	88	8,8	4	0,2	6	PTB-80x88x8.8-J1S
	90	6,6	5	0,2	6	PTB-80x90x6.6-J1S
	90	8,8	5	0,2	6	PTB-80x90x8.8-J1S
	90	11	5	0,2	6	PTB-80x90x11-J1S
	90	13,2	5	0,2	6	PTB-80x90x13.2-J1S
	92	10,5	6	0,2	7	PTB-80x92x10.5-J1S
	93	11	6,5	0,2	7,5	PTB-80x93x11-J1S
	95	9,9	7,5	0,5	8,5	PTB-80x95x9.9-J1S
	95	11	7,5	0,5	8,5	PTB-80x95x11-J1S
	95	12,1	7,5	0,5	8,5	PTB-80x95x12.1-J1S
95	12,5	7,5	0,5	8,5	• PTB-80x95x12.5-J1S	
	100	13,2	10	0,8	11	PTB-80x100x13.2-J1S
	100	16	10	0,8	11	• PTB-80x100x16-J1S
	100	16,5	10	0,8	11	PTB-80x100x16.5-J1S
82	92	11	5	0,2	6	PTB-82x92x11-J1S
84	98	13,2	7	0,5	8,5	PTB-84x98x13.2-J1S
85	95	6,6	5	0,2	6	PTB-85x95x6.6-J1S
	100	9,9	7,5	0,5	8,5	PTB-85x100x9.9-J1S
	100	11	7,5	0,5	8,5	PTB-85x100x11-J1S
	100	13,2	7,5	0,5	8,5	PTB-85x100x13.2-J1S
	105	13,2	10	0,8	11	PTB-85x105x13.2-J1S

• Dimensions in accordance with ISO 5597

### 3.4 PTB profile rod seals, metric sizes d 87 – 150 mm

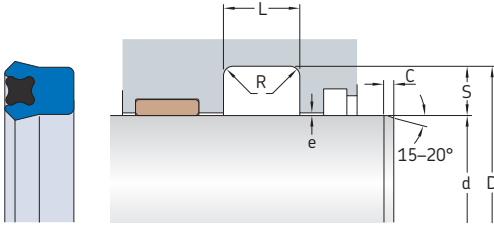

#### Maximum extrusion gap e

Radial depth S	$e_{max}$ at 60 °C (140 °F) for pressures		
	160 bar	250 bar	400 bar
mm	mm		
3	0,2	0,1	–
3,5 to 4	0,35	0,2	–
4,5 to 6,5	0,45	0,25	0,1
7 to 8	0,5	0,3	0,15
9 to 11,5	0,55	0,3	0,15
12,5	0,6	0,3	0,2
15	0,6	0,3	0,2

#### Cylinder dimensions

#### Designation

d h9	D H9	L +0,2	S	R max.	C min.	
mm						–
87	110	11	11,5	0,8	13	PTB-87x110x11-J1S
88	102	11,6	7	0,5	8,5	PTB-88x102x11.6-J1S
90	98	8,8	4	0,2	6	PTB-90x98x8.8-J1S
	100	6,6	5	0,2	6	PTB-90x100x6.6-J1S
	100	7,7	5	0,2	6	PTB-90x100x7.7-J1S
	105	9,9	7,5	0,5	8,5	PTB-90x105x9.9-J1S
	105	11	7,5	0,5	8,5	PTB-90x105x11-J1S
	105	12,5	7,5	0,5	8,5	• PTB-90x105x12.5-J1S
	105	13,2	7,5	0,5	8,5	PTB-90x105x13.2-J1S
	110	13,2	10	0,8	11	PTB-90x110x13.2-J1S
	110	16	10	0,8	11	• PTB-90x110x16-J1S
92	102	11	5	0,2	6	PTB-92x102x11-J1S
95	105	6,6	5	0,2	6	PTB-95x105x6.6-J1S
	110	9,9	7,5	0,5	8,5	PTB-95x110x9.9-J1S
	110	11	7,5	0,5	8,5	PTB-95x110x11-J1S
	110	13,2	7,5	0,5	8,5	PTB-95x110x13.2-J1S
	115	13,2	10	0,8	11	PTB-95x115x13.2-J1S
97	105	14,3	4	0,2	6	PTB-97x105x14.3-J1S
98	110	17,6	6	0,2	7	PTB-98x110x17.6-J1S
100	108	8,8	4	0,2	6	PTB-100x108x8.8-J1S
	115	9,9	7,5	0,5	8,5	PTB-100x115x9.9-J1S
	115	11	7,5	0,5	8,5	PTB-100x115x11-J1S
	115	13,2	7,5	0,5	8,5	PTB-100x115x13.2-J1S
	120	13,2	10	0,8	11	PTB-100x120x13.2-J1S
	120	16	10	0,8	11	• PTB-100x120x16-J1S
	125	13,6	12,5	0,8	13	PTB-100x125x13.6-J1S
	125	16,5	12,5	0,8	13	PTB-100x125x16.5-J1S
105	120	9,9	7,5	0,5	8,5	PTB-105x120x9.9-J1S

• Dimensions in accordance with ISO 5597

Cylinder dimensions						Designation
d h9	D H9	L +0,2	S	R max.	C min.	
mm						-
105 cont.	120	11	7,5	0,5	8,5	PTB-105x120x11-J1S
	125	12,5	10	0,8	11	PTB-105x125x12.5-J1S
	125	13,2	10	0,8	11	PTB-105x125x13.2-J1S
	125	16,5	10	0,8	11	PTB-105x125x16.5-J1S
109	125	11,6	8	0,5	8,5	PTB-109x125x11.6-J1S
110	125	9,9	7,5	0,5	8,5	PTB-110x125x9.9-J1S
	125	10,1	7,5	0,5	8,5	PTB-110x125x10.1-J1S
	125	11	7,5	0,5	8,5	PTB-110x125x11-J1S
	125	13,2	7,5	0,5	8,5	PTB-110x125x13.2-J1S
	130	11	10	0,8	11	PTB-110x130x11-J1S
	130	13,2	10	0,8	11	PTB-110x130x13.2-J1S
	130	16	10	0,8	11	• PTB-110x130x16-J1S
	130	16,5	10	0,8	11	PTB-110x130x16.5-J1S
135	19,8	12,5	0,8	13	• PTB-110x135x19.8-J1S	
112	125	7,7	6,5	0,2	7,5	PTB-112x125x7.7-J1S
115	130	9,4	7,5	0,5	8,5	PTB-115x130x9.4-J1S
	130	9,9	7,5	0,5	8,5	PTB-115x130x9.9-J1S
	135	13,2	10	0,8	11	PTB-115x135x13.2-J1S
	140	19,8	12,5	0,8	13	PTB-115x140x19.8-J1S
118	133	9,9	7,5	0,5	8,5	PTB-118x133x9.9-J1S
120	130	16,5	5	0,2	6	PTB-120x130x16.5-J1S
	135	9,9	7,5	0,5	8,5	PTB-120x135x9.9-J1S
	140	11	10	0,8	11	PTB-120x140x11-J1S
	140	13,2	10	0,8	11	PTB-120x140x13.2-J1S
	140	16	10	0,8	11	PTB-120x140x16-J1S
	140	16,5	10	0,8	11	PTB-120x140x16.5-J1S
125	140	9,9	7,5	0,5	8,5	PTB-125x140x9.9-J1S
	140	16,5	7,5	0,5	8,5	PTB-125x140x16.5-J1S
	145	16	10	0,8	11	• PTB-125x145x16-J1S
	145	16,5	10	0,8	11	PTB-125x145x16.5-J1S
	150	19,8	12,5	0,8	13	• PTB-125x150x19.8-J1S
130	145	9,9	7,5	0,5	8,5	PTB-130x145x9.9-J1S
	150	13,2	10	0,8	11	PTB-130x150x13.2-J1S
	150	14,3	10	0,8	11	PTB-130x150x14.3-J1S
	150	16,5	10	0,8	11	PTB-130x150x16.5-J1S
	150	17,6	10	0,8	11	PTB-130x150x17.6-J1S
	160	18,7	15	0,8	14	PTB-130x160x18.7-J1S
	135	150	9,9	7,5	0,5	8,5
155		16,5	10	0,8	11	PTB-135x155x16.5-J1S
136	150	9,9	7	0,5	8,5	PTB-136x150x9.9-J1S
140	155	9,9	7,5	0,5	8,5	PTB-140x155x9.9-J1S
	160	13,2	10	0,8	11	PTB-140x160x13.2-J1S
	160	15,4	10	0,8	11	PTB-140x160x15.4-J1S
	160	16	10	0,8	11	• PTB-140x160x16-J1S
	160	16,5	10	0,8	11	PTB-140x160x16.5-J1S
145	160	7,7	7,5	0,5	8,5	PTB-145x160x7.7-J1S
	160	9,9	7,5	0,5	8,5	PTB-145x160x9.9-J1S
150	160	8,8	5	0,2	6	PTB-150x160x8.8-J1S
	165	9,9	7,5	0,5	8,5	PTB-150x165x9.9-J1S
	170	16,5	10	0,8	11	PTB-150x170x16.5-J1S
	170	17,6	10	0,8	11	PTB-150x170x17.6-J1S
	180	19,8	15	0,8	14	PTB-150x180x19.8-J1S

• Dimensions in accordance with ISO 5597

### 3.4 PTB profile rod seals, metric sizes d 155 – 205 mm

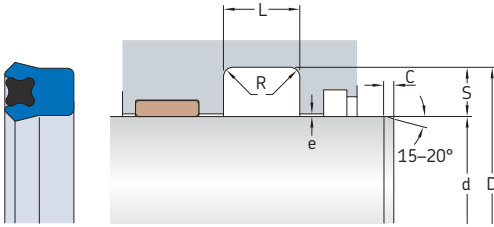

#### Maximum extrusion gap e

Radial depth S	$e_{max}$ at 60 °C (140 °F) for pressures		
	160 bar	250 bar	400 bar
mm	mm		
3	0,2	0,1	–
3,5 to 4	0,35	0,2	–
4,5 to 6,5	0,45	0,25	0,1
7 to 8	0,5	0,3	0,15
9 to 11,5	0,55	0,3	0,15
12,5	0,6	0,3	0,2
15	0,6	0,3	0,2

#### Cylinder dimensions

#### Designation

d h9	D H9	L +0,2	S	R max.	C min.	Designation
mm						–
155	180	16,5	12,5	0,8	13	PTB-155x180x16.5-J1S
	180	17,6	12,5	0,8	13	PTB-155x180x17.6-J1S
160	175	9,9	7,5	0,5	8,5	PTB-160x175x9.9-J1S
	180	16,5	10	0,8	11	PTB-160x180x16.5-J1S
	185	17,6	12,5	0,8	13	PTB-160x185x17.6-J1S
	185	19,8	12,5	0,8	13	PTB-160x185x19.8-J1S
	190	25	15	0,8	14	PTB-160x190x25-J1S
165	180	10,5	7,5	0,5	8,5	PTB-165x180x10.5-J1S
	190	17,6	12,5	0,8	13	PTB-165x190x17.6-J1S
170	190	16,5	10	0,8	11	PTB-170x190x16.5-J1S
	195	17,6	12,5	0,8	13	PTB-170x195x17.6-J1S
	200	16,5	15	0,8	14	PTB-170x200x16.5-J1S
175	185	12,5	5	0,2	6	PTB-175x185x12.5-J1S
	200	16,5	12,5	0,8	13	PTB-175x200x16.5-J1S
	200	19,8	12,5	0,8	13	PTB-175x200x19.8-J1S
180	200	13,8	10	0,8	11	PTB-180x200x13.8-J1S
	205	16,5	12,5	0,8	13	PTB-180x205x16.5-J1S
	205	17,6	12,5	0,8	13	PTB-180x205x17.6-J1S
190	210	13,2	10	0,8	11	PTB-190x210x13.2-J1S
	210	16,5	10	0,8	11	PTB-190x210x16.5-J1S
	215	16,5	12,5	0,8	13	PTB-190x215x16.5-J1S
	215	17,6	12,5	0,8	13	PTB-190x215x17.6-J1S
199	224	17,6	12,5	0,8	13	PTB-199x224x17.6-J1S
200	220	13,8	10	0,8	11	PTB-200x220x13.8-J1S
	220	16,5	10	0,8	11	PTB-200x220x16.5-J1S
	225	16,5	12,5	0,8	13	PTB-200x225x16.5-J1S
	225	17,6	12,5	0,8	13	PTB-200x225x17.6-J1S
205	235	19,8	15	0,8	14	PTB-205x235x19.8-J1S

Other sizes are available on request

### 3.4 PTB profile rod seals, inch sizes d 0.125 – 0.688 in.

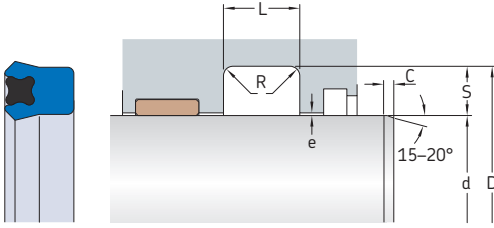

#### Maximum extrusion gap e

Radial depth	$e_{max}$ at 60 °C (140 °F) for pressures		
	2 300 psi	3 600 psi	5 800 psi
S			
in.	in.		
<b>0.125</b>	0.008	0.004	–
<b>0.156 to 0.187</b>	0.014	0.008	–
<b>0.218 to 0.25</b>	0.018	0.010	0.004
<b>0.281 to 0.437</b>	0.020	0.012	0.006
<b>0.5 to 0.562</b>	0.024	0.012	0.008
<b>0.625 to 0.75</b>	0.024	0.012	0.008

#### Cylinder dimensions

#### Designation

d	Tolerance	D	Tolerance	L	S	R	C	Designation
				+0.01		max.	min.	
in.								–
<b>0.125</b>	–0.001	0.375	+0.002	0.275	0.125	0.015	0.25	<b>PTB125-125-250-J1S</b>
<b>0.187</b>	–0.001	0.437	+0.002	0.206	0.125	0.015	0.25	<b>PTB125-187-187-J1S</b>
	–0.001	0.437	+0.002	0.275	0.125	0.015	0.25	<b>PTB125-187-250-J1S</b>
<b>0.25</b>	–0.001	0.5	+0.002	0.275	0.125	0.015	0.25	<b>PTB125-250-250-J1S</b>
<b>0.282</b>	–0.001	0.532	+0.002	0.275	0.125	0.015	0.25	<b>PTB125-282-250-J1S</b>
<b>0.312</b>	–0.001	0.562	+0.002	0.275	0.125	0.015	0.25	<b>PTB125-312-250-J1S</b>
	–0.001	0.687	+0.002	0.343	0.187	0.015	0.25	<b>PTB187-312-312-J1S</b>
<b>0.375</b>	–0.001	0.625	+0.002	0.275	0.125	0.015	0.25	<b>PTB125-375-250-J1S</b>
	–0.001	0.75	+0.002	0.343	0.187	0.015	0.25	<b>PTB187-375-312-J1S</b>
<b>0.437</b>	–0.001	0.687	+0.002	0.275	0.125	0.015	0.25	<b>PTB125-437-250-J1S</b>
	–0.001	0.687	+0.002	0.413	0.125	0.015	0.25	<b>PTB125-437-375-J1S</b>
	–0.002	0.937	+0.003	0.413	0.25	0.02	0.312	<b>PTB250-437-375-J1S</b>
<b>0.5</b>	–0.001	0.75	+0.002	0.193	0.125	0.015	0.25	<b>PTB125-500-175-J1S</b>
	–0.001	0.75	+0.002	0.275	0.125	0.015	0.25	<b>PTB125-500-250-J1S</b>
	–0.001	0.875	+0.002	0.343	0.187	0.015	0.25	<b>PTB187-500-312-J1S</b>
	–0.002	1	+0.003	0.413	0.25	0.02	0.312	<b>PTB250-500-375-J1S</b>
<b>0.54</b>	–0.001	0.915	+0.002	0.343	0.187	0.015	0.25	<b>PTB187-540-312-J1S</b>
<b>0.562</b>	–0.001	0.812	+0.002	0.275	0.125	0.015	0.25	<b>PTB125-562-250-J1S</b>
	–0.001	0.937	+0.002	0.343	0.187	0.015	0.25	<b>PTB187-562-312-J1S</b>
<b>0.625</b>	–0.001	0.875	+0.002	0.196	0.125	0.015	0.25	<b>PTB125-625-178-J1S</b>
	–0.001	0.875	+0.002	0.275	0.125	0.015	0.25	<b>PTB125-625-250-J1S</b>
	–0.001	1	+0.002	0.343	0.187	0.015	0.25	<b>PTB187-625-312-J1S</b>
<b>0.687</b>	–0.001	0.937	+0.002	0.275	0.125	0.015	0.25	<b>PTB125-687-250-J1S</b>
	–0.001	1.062	+0.002	0.343	0.187	0.015	0.25	<b>PTB187-687-312-J1S</b>
	–0.002	1.187	+0.003	0.413	0.25	0.02	0.312	<b>PTB250-687-375-J1S</b>
<b>0.688</b>	–0.001	0.938	+0.002	0.196	0.125	0.015	0.25	<b>PTB125-688-178-J1S</b>

### 3.4 PTB profile rod seals, inch sizes d 0.75 – 1.625 in.

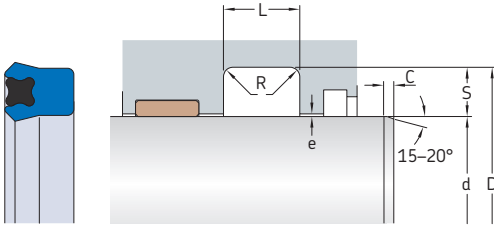

#### Maximum extrusion gap e

Radial depth	$e_{\max}$ at 60 °C (140 °F) for pressures		
	2 300 psi	3 600 psi	5 800 psi
S	2 300 psi	3 600 psi	5 800 psi
in.	in.		
<b>0.125</b>	0.008	0.004	–
<b>0.156 to 0.187</b>	0.014	0.008	–
<b>0.218 to 0.25</b>	0.018	0.010	0.004
<b>0.281 to 0.437</b>	0.020	0.012	0.006
<b>0.5 to 0.562</b>	0.024	0.012	0.008
<b>0.625 to 0.75</b>	0.024	0.012	0.008

#### Cylinder dimensions

#### Designation

d	Tolerance	D	Tolerance	L +0.01	S	R max.	C min.	Designation	
in.								–	
<b>0.75</b>	-0.001	1	+0.002	0.196	0.125	0.015	0.25	<b>PTB125-750-178-J15</b>	
	-0.001	1	+0.002	0.206	0.125	0.015	0.25	<b>PTB125-750-187-J15</b>	
	-0.001	1	+0.002	0.275	0.125	0.015	0.25	<b>PTB125-750-250-J15</b>	
	-0.001	1.125	+0.002	0.343	0.187	0.015	0.25	<b>PTB187-750-312-J15</b>	
	-0.002	1.25	+0.003	0.413	0.25	0.02	0.312	<b>PTB250-750-375-J15</b>	
-0.002	1.375	+0.003	0.550	0.312	0.02	0.312	<b>PTB312-750-500-J15</b>		
<b>0.812</b>	-0.001	1.062	+0.002	0.275	0.125	0.015	0.25	<b>PTB125-812-250-J15</b>	
	-0.001	1.187	+0.002	0.343	0.187	0.015	0.25	<b>PTB187-812-312-J15</b>	
	-0.002	1.312	+0.003	0.413	0.25	0.02	0.312	<b>PTB250-812-375-J15</b>	
<b>0.875</b>	-0.001	1.125	+0.002	0.275	0.125	0.015	0.25	<b>PTB125-875-250-J15</b>	
	-0.001	1.25	+0.002	0.343	0.187	0.015	0.25	<b>PTB187-875-312-J15</b>	
	-0.002	1.375	+0.003	0.413	0.25	0.02	0.312	<b>PTB250-875-375-J15</b>	
<b>0.937</b>	-0.001	1.187	+0.002	0.275	0.125	0.015	0.25	<b>PTB125-937-250-J15</b>	
	-0.001	1.312	+0.002	0.343	0.187	0.015	0.25	<b>PTB187-937-312-J15</b>	
	-0.002	1.562	+0.003	0.413	0.312	0.02	0.312	<b>PTB312-937-375-J15</b>	
<b>1</b>	-0.001	1.25	+0.002	0.206	0.125	0.015	0.25	<b>PTB125-1000-187-J15</b>	
	-0.001	1.25	+0.002	0.275	0.125	0.015	0.25	<b>PTB125-1000-250-J15</b>	
	-0.001	1.312	+0.002	0.240	0.156	0.015	0.25	<b>PTB156-1000-218-J15</b>	
	-0.001	1.312	+0.002	0.257	0.156	0.015	0.25	<b>PTB156-1000-234-J15</b>	
	-0.001	1.375	+0.002	0.275	0.187	0.015	0.25	<b>PTB187-1000-250-J15</b>	
	-0.001	1.375	+0.002	0.293	0.187	0.015	0.25	<b>PTB187-1000-266-J15</b>	
	-0.001	1.375	+0.002	0.343	0.187	0.015	0.25	<b>PTB187-1000-312-J15</b>	
	-0.001	1.375	+0.002	0.413	0.187	0.015	0.25	<b>PTB187-1000-375-J15</b>	
	-0.002	1.5	+0.003	0.413	0.25	0.02	0.312	<b>PTB250-1000-375-J15</b>	
	-0.002	1.625	+0.003	0.413	0.312	0.02	0.312	<b>PTB312-1000-375-J15</b>	
	-0.002	1.625	+0.003	0.550	0.312	0.02	0.312	<b>PTB312-1000-500-J15</b>	
	<b>1.062</b>	-0.001	1.312	+0.002	0.275	0.125	0.015	0.25	<b>PTB125-1062-250-J15</b>
		-0.001	1.437	+0.002	0.343	0.187	0.015	0.25	<b>PTB187-1062-312-J15</b>
<b>1.125</b>	-0.001	1.375	+0.002	0.275	0.125	0.015	0.25	<b>PTB125-1125-250-J15</b>	
	-0.001	1.5	+0.002	0.275	0.187	0.015	0.25	<b>PTB187-1125-250-J15</b>	
	-0.001	1.5	+0.002	0.343	0.187	0.015	0.25	<b>PTB187-1125-312-J15</b>	
	-0.001	1.5	+0.002	0.413	0.187	0.015	0.25	<b>PTB187-1125-375-J15</b>	
	-0.002	1.625	+0.003	0.413	0.25	0.02	0.312	<b>PTB250-1125-375-J15</b>	
	-0.002	1.75	+0.003	0.413	0.312	0.02	0.312	<b>PTB312-1125-375-J15</b>	



Cylinder dimensions								Designation	
d	Tolerance	D	Tolerance	L +0.01	S	R max.	C min.		
in.								-	
<b>1.187</b>	-0.001	1.437	+0.002	0.196	0.125	0.015	0.25	PTB125-1187-178-J15	
	-0.001	1.437	+0.002	0.206	0.125	0.015	0.25	PTB125-1187-187-J15	
	-0.001	1.437	+0.002	0.275	0.125	0.015	0.25	PTB125-1187-250-J15	
	-0.001	1.562	+0.002	0.275	0.187	0.015	0.25	PTB187-1187-250-J15	
	-0.001	1.562	+0.002	0.343	0.187	0.015	0.25	PTB187-1187-312-J15	
<b>1.25</b>	-0.001	1.5	+0.002	0.206	0.125	0.015	0.25	PTB125-1250-187-J15	
	-0.001	1.5	+0.002	0.275	0.125	0.015	0.25	PTB125-1250-250-J15	
	-0.001	1.625	+0.002	0.275	0.187	0.015	0.25	PTB187-1250-250-J15	
	-0.001	1.625	+0.002	0.293	0.187	0.015	0.25	PTB187-1250-266-J15	
	-0.001	1.625	+0.002	0.343	0.187	0.015	0.25	PTB187-1250-312-J15	
	-0.001	1.625	+0.002	0.413	0.187	0.015	0.25	PTB187-1250-375-J15	
	-0.002	1.75	+0.003	0.413	0.25	0.02	0.312	PTB250-1250-375-J15	
	-0.002	1.875	+0.003	0.413	0.312	0.02	0.312	PTB312-1250-375-J15	
	-0.002	1.875	+0.003	0.550	0.312	0.02	0.312	PTB312-1250-500-J15	
	-0.003	2.25	+0.007	0.825	0.5	0.03	0.625	PTB500-1250-750-J15	
	<b>1.312</b>	-0.001	1.562	+0.002	0.206	0.125	0.015	0.25	PTB125-1312-187-J15
		-0.001	1.687	+0.002	0.343	0.187	0.015	0.25	PTB187-1312-312-J15
-0.002		1.812	+0.003	0.413	0.25	0.02	0.312	PTB250-1312-375-J15	
<b>1.375</b>	-0.001	1.625	+0.002	0.275	0.125	0.015	0.25	PTB125-1375-250-J15	
	-0.001	1.687	+0.002	0.240	0.156	0.015	0.25	PTB156-1375-218-J15	
	-0.001	1.75	+0.002	0.275	0.187	0.015	0.25	PTB187-1375-250-J15	
	-0.001	1.75	+0.002	0.293	0.187	0.015	0.25	PTB187-1375-266-J15	
	-0.001	1.75	+0.002	0.343	0.187	0.015	0.25	PTB187-1375-312-J15	
	-0.001	1.75	+0.002	0.413	0.187	0.015	0.25	PTB187-1375-375-J15	
	-0.002	1.875	+0.003	0.413	0.25	0.02	0.312	PTB250-1375-375-J15	
	-0.002	2	+0.003	0.413	0.312	0.02	0.312	PTB312-1375-375-J15	
	-0.002	2	+0.003	0.550	0.312	0.02	0.312	PTB312-1375-500-J15	
	<b>1.437</b>	-0.001	1.687	+0.002	0.275	0.125	0.015	0.25	PTB125-1437-250-J15
-0.001		1.812	+0.002	0.343	0.187	0.015	0.25	PTB187-1437-312-J15	
-0.002		1.937	+0.003	0.413	0.25	0.02	0.312	PTB250-1437-375-J15	
<b>1.5</b>	-0.001	1.75	+0.002	0.206	0.125	0.015	0.25	PTB125-1500-187-J15	
	-0.001	1.75	+0.002	0.275	0.125	0.015	0.25	PTB125-1500-250-J15	
	-0.001	1.812	+0.002	0.343	0.156	0.015	0.25	PTB156-1500-312-J15	
	-0.001	1.875	+0.002	0.275	0.187	0.015	0.25	PTB187-1500-250-J15	
	-0.001	1.875	+0.002	0.286	0.187	0.015	0.25	PTB187-1500-260-J15	
	-0.001	1.875	+0.002	0.293	0.187	0.015	0.25	PTB187-1500-266-J15	
	-0.001	1.875	+0.002	0.343	0.187	0.015	0.25	PTB187-1500-312-J15	
	-0.001	1.875	+0.002	0.413	0.187	0.015	0.25	PTB187-1500-375-J15	
	-0.002	2	+0.003	0.343	0.25	0.02	0.312	PTB250-1500-312-J15	
	-0.002	2	+0.003	0.413	0.25	0.02	0.312	PTB250-1500-375-J15	
	-0.002	2	+0.003	0.550	0.25	0.02	0.312	PTB250-1500-500-J15	
	-0.002	2.125	+0.003	0.481	0.312	0.02	0.312	PTB312-1500-437-J15	
	-0.002	2.125	+0.003	0.550	0.312	0.02	0.312	PTB312-1500-500-J15	
	-0.002	2.25	+0.004	0.550	0.375	0.03	0.5	PTB375-1500-500-J15	
	-0.002	2.25	+0.004	0.688	0.375	0.03	0.5	PTB375-1500-625-J15	
	<b>1.562</b>	-0.001	1.937	+0.002	0.413	0.187	0.015	0.25	PTB187-1562-375-J15
-0.002		2	+0.003	0.343	0.218	0.02	0.312	PTB218-1562-312-J15	
-0.002		2.062	+0.003	0.343	0.25	0.02	0.312	PTB250-1562-312-J15	
<b>1.625</b>	-0.001	2	+0.002	0.275	0.187	0.015	0.25	PTB187-1625-250-J15	
	-0.001	2	+0.002	0.293	0.187	0.015	0.25	PTB187-1625-266-J15	
	-0.001	2	+0.002	0.343	0.187	0.015	0.25	PTB187-1625-312-J15	
	-0.001	2	+0.002	0.413	0.187	0.015	0.25	PTB187-1625-375-J15	

### 3.4 PTB profile rod seals, inch sizes d 1.625 – 2.5 in.

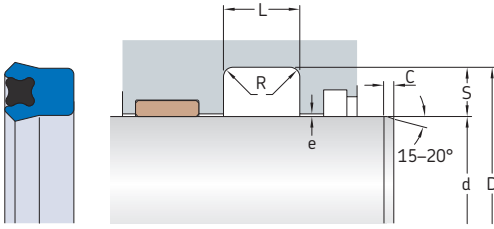

#### Maximum extrusion gap e

Radial depth	$e_{max}$ at 60 °C (140 °F) for pressures		
	2 300 psi	3 600 psi	5 800 psi
S			
in.	in.		
<b>0.125</b>	0.008	0.004	–
<b>0.156 to 0.187</b>	0.014	0.008	–
<b>0.218 to 0.25</b>	0.018	0.010	0.004
<b>0.281 to 0.437</b>	0.020	0.012	0.006
<b>0.5 to 0.562</b>	0.024	0.012	0.008
<b>0.625 to 0.75</b>	0.024	0.012	0.008

#### Cylinder dimensions

#### Designation

d	Tolerance	D	Tolerance	L	S	R	C	Designation
				+0.01		max.	min.	
in.								–
<b>1.625</b>	-0.002	2.125	+0.003	0.413	0.25	0.02	0.312	<b>PTB250-1625-375-J15</b>
cont.	-0.002	2.25	+0.003	0.413	0.312	0.02	0.312	<b>PTB312-1625-375-J15</b>
	-0.002	2.25	+0.003	0.550	0.312	0.02	0.312	<b>PTB312-1625-500-J15</b>
	-0.002	2.375	+0.004	0.688	0.375	0.03	0.5	<b>PTB375-1625-625-J15</b>
<b>1.687</b>	-0.002	2.312	+0.003	0.550	0.312	0.02	0.312	<b>PTB312-1687-500-J15</b>
<b>1.75</b>	-0.001	2	+0.002	0.275	0.125	0.015	0.25	<b>PTB125-1750-250-J15</b>
	-0.001	2.125	+0.002	0.275	0.187	0.015	0.25	<b>PTB187-1750-250-J15</b>
	-0.001	2.125	+0.002	0.293	0.187	0.015	0.25	<b>PTB187-1750-266-J15</b>
	-0.001	2.125	+0.002	0.343	0.187	0.015	0.25	<b>PTB187-1750-312-J15</b>
	-0.001	2.125	+0.002	0.413	0.187	0.015	0.25	<b>PTB187-1750-375-J15</b>
	-0.002	2.25	+0.003	0.343	0.25	0.02	0.312	<b>PTB250-1750-312-J15</b>
	-0.002	2.25	+0.003	0.413	0.25	0.02	0.312	<b>PTB250-1750-375-J15</b>
	-0.002	2.375	+0.003	0.413	0.312	0.02	0.312	<b>PTB312-1750-375-J15</b>
	-0.002	2.375	+0.003	0.550	0.312	0.02	0.312	<b>PTB312-1750-500-J15</b>
	-0.002	2.5	+0.004	0.688	0.375	0.03	0.5	<b>PTB375-1750-625-J15</b>
	-0.003	2.5	+0.007	0.825	0.5	0.03	0.625	<b>PTB500-1750-750-J15</b>
<b>1.875</b>	-0.001	2.25	+0.002	0.293	0.187	0.015	0.25	<b>PTB187-1875-266-J15</b>
	-0.001	2.25	+0.002	0.343	0.187	0.015	0.25	<b>PTB187-1875-312-J15</b>
	-0.001	2.25	+0.002	0.413	0.187	0.015	0.25	<b>PTB187-1875-375-J15</b>
	-0.002	2.375	+0.003	0.413	0.25	0.02	0.312	<b>PTB250-1875-375-J15</b>
	-0.002	2.5	+0.003	0.413	0.312	0.02	0.312	<b>PTB312-1875-375-J15</b>
	-0.002	2.5	+0.003	0.550	0.312	0.02	0.312	<b>PTB312-1875-500-J15</b>
	-0.003	2.875	+0.007	0.688	0.5	0.03	0.625	<b>PTB500-1875-625-J15</b>
<b>2</b>	-0.001	2.25	+0.002	0.275	0.125	0.015	0.25	<b>PTB125-2000-250-J15</b>
	-0.001	2.375	+0.002	0.253	0.187	0.015	0.25	<b>PTB187-2000-230-J15</b>
	-0.001	2.375	+0.002	0.275	0.187	0.015	0.25	<b>PTB187-2000-250-J15</b>
	-0.001	2.375	+0.002	0.343	0.187	0.015	0.25	<b>PTB187-2000-312-J15</b>
	-0.001	2.375	+0.002	0.391	0.187	0.015	0.25	<b>PTB187-2000-355-J15</b>
	-0.001	2.375	+0.002	0.413	0.187	0.015	0.25	<b>PTB187-2000-375-J15</b>
	-0.002	2.5	+0.003	0.343	0.25	0.02	0.312	<b>PTB250-2000-312-J15</b>
	-0.002	2.5	+0.003	0.413	0.25	0.02	0.312	<b>PTB250-2000-375-J15</b>
	-0.002	2.5	+0.003	0.550	0.25	0.02	0.312	<b>PTB250-2000-500-J15</b>

Cylinder dimensions							Designation	
d	Tolerance	D	Tolerance	L +0.01	S	R max.	C min.	
in.								-
<b>2</b> cont.	-0.002	2.625	+0.003	0.413	0.312	0.02	0.312	PTB312-2000-375-J1S
	-0.002	2.625	+0.003	0.481	0.312	0.02	0.312	PTB312-2000-437-J1S
	-0.002	2.625	+0.003	0.550	0.312	0.02	0.312	PTB312-2000-500-J1S
	-0.002	2.75	+0.004	0.481	0.375	0.03	0.5	PTB375-2000-437-J1S
	-0.002	2.75	+0.004	0.550	0.375	0.03	0.5	PTB375-2000-500-J1S
	-0.002	2.75	+0.004	0.688	0.375	0.03	0.5	PTB375-2000-625-J1S
	-0.003	3	+0.007	0.825	0.5	0.03	0.625	PTB500-2000-750-J1S
<b>2.125</b>	-0.001	2.5	+0.002	0.275	0.187	0.015	0.25	PTB187-2125-250-J1S
	-0.001	2.5	+0.002	0.293	0.187	0.015	0.25	PTB187-2125-266-J1S
	-0.001	2.5	+0.002	0.343	0.187	0.015	0.25	PTB187-2125-312-J1S
	-0.001	2.5	+0.002	0.413	0.187	0.015	0.25	PTB187-2125-375-J1S
	-0.002	2.625	+0.003	0.413	0.25	0.02	0.312	PTB250-2125-375-J1S
	-0.002	2.75	+0.003	0.413	0.312	0.02	0.312	PTB312-2125-375-J1S
	-0.002	2.75	+0.003	0.550	0.312	0.02	0.312	PTB312-2125-500-J1S
	-0.002	2.875	+0.004	0.688	0.375	0.03	0.5	PTB375-2125-625-J1S
<b>2.187</b>	-0.001	2.562	+0.002	0.413	0.187	0.015	0.25	PTB187-2187-375-J1S
	-0.002	2.687	+0.003	0.413	0.25	0.02	0.312	PTB250-2187-375-J1S
	-0.002	2.937	+0.004	0.688	0.375	0.03	0.5	PTB375-2187-625-J1S
<b>2.25</b>	-0.001	2.625	+0.002	0.343	0.187	0.015	0.25	PTB187-2250-312-J1S
	-0.001	2.625	+0.002	0.413	0.187	0.015	0.25	PTB187-2250-375-J1S
	-0.002	2.75	+0.003	0.413	0.25	0.02	0.312	PTB250-2250-375-J1S
	-0.002	2.875	+0.003	0.413	0.312	0.02	0.312	PTB312-2250-375-J1S
	-0.002	2.875	+0.003	0.550	0.312	0.02	0.312	PTB312-2250-500-J1S
	-0.002	3	+0.004	0.550	0.375	0.03	0.5	PTB375-2250-500-J1S
	-0.002	3	+0.004	0.688	0.375	0.03	0.5	PTB375-2250-625-J1S
<b>2.375</b>	-0.001	2.625	+0.002	0.206	0.125	0.015	0.25	PTB125-2375-187-J1S
	-0.001	2.75	+0.002	0.275	0.187	0.015	0.25	PTB187-2375-250-J1S
	-0.001	2.75	+0.002	0.293	0.187	0.015	0.25	PTB187-2375-266-J1S
	-0.001	2.75	+0.002	0.413	0.187	0.015	0.25	PTB187-2375-375-J1S
	-0.001	2.75	+0.002	0.550	0.187	0.015	0.25	PTB187-2375-500-J1S
	-0.002	2.875	+0.003	0.413	0.25	0.02	0.312	PTB250-2375-375-J1S
	-0.002	3	+0.003	0.550	0.312	0.02	0.312	PTB312-2375-500-J1S
	-0.002	3.125	+0.004	0.550	0.375	0.03	0.5	PTB375-2375-500-J1S
	-0.002	3.125	+0.004	0.688	0.375	0.03	0.5	PTB375-2375-625-J1S
<b>2.437</b>	-0.002	3	+0.003	0.413	0.281	0.02	0.312	PTB281-2437-375-J1S
<b>2.5</b>	-0.001	2.75	+0.002	0.275	0.125	0.015	0.25	PTB125-2500-250-J1S
	-0.001	2.875	+0.002	0.275	0.187	0.015	0.25	PTB187-2500-250-J1S
	-0.001	2.875	+0.002	0.293	0.187	0.015	0.25	PTB187-2500-266-J1S
	-0.001	2.875	+0.002	0.343	0.187	0.015	0.25	PTB187-2500-312-J1S
	-0.001	2.875	+0.002	0.413	0.187	0.015	0.25	PTB187-2500-375-J1S
	-0.002	2.937	+0.003	0.309	0.218	0.02	0.312	PTB218-2500-281-J1S
	-0.002	3	+0.003	0.343	0.25	0.02	0.312	PTB250-2500-312-J1S
	-0.002	3	+0.003	0.413	0.25	0.02	0.312	PTB250-2500-375-J1S
	-0.002	3	+0.003	0.550	0.25	0.02	0.312	PTB250-2500-500-J1S
	-0.002	3.125	+0.003	0.413	0.312	0.02	0.312	PTB312-2500-375-J1S
	-0.002	3.125	+0.003	0.550	0.312	0.02	0.312	PTB312-2500-500-J1S
	-0.002	3.25	+0.004	0.550	0.375	0.03	0.5	PTB375-2500-500-J1S
	-0.002	3.25	+0.004	0.688	0.375	0.03	0.5	PTB375-2500-625-J1S
	-0.003	3.5	+0.007	0.825	0.5	0.03	0.5	PTB500-2500-750-J1S

3.4

### 3.4 PTB profile rod seals, inch sizes d 2.625 – 3.75 in.

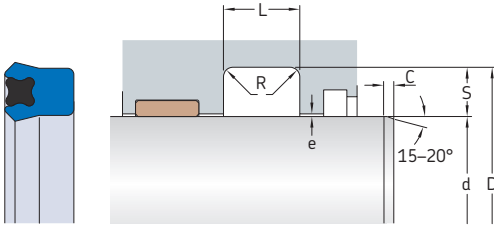

#### Maximum extrusion gap e

Radial depth	$e_{max}$ at 60 °C (140 °F) for pressures		
	2 300 psi	3 600 psi	5 800 psi
S			
in.	in.		
<b>0.125</b>	0.008	0.004	–
<b>0.156 to 0.187</b>	0.014	0.008	–
<b>0.218 to 0.25</b>	0.018	0.010	0.004
<b>0.281 to 0.437</b>	0.020	0.012	0.006
<b>0.5 to 0.562</b>	0.024	0.012	0.008
<b>0.625 to 0.75</b>	0.024	0.012	0.008

#### Cylinder dimensions

#### Designation

d	Tolerance	D	Tolerance	L	S	R	C	Designation	
				+0.01		max.	min.		
in.								–	
<b>2.625</b>	-0.001	3	+0.002	0.275	0.187	0.015	0.25	<b>PTB187-2625-250-J1S</b>	
	-0.001	3	+0.002	0.293	0.187	0.015	0.25	<b>PTB187-2625-266-J1S</b>	
	-0.001	3	+0.002	0.309	0.187	0.015	0.25	<b>PTB187-2625-281-J1S</b>	
	-0.001	3	+0.002	0.413	0.187	0.015	0.25	<b>PTB187-2625-375-J1S</b>	
	-0.002	3.125	+0.003	0.413	0.25	0.02	0.312	<b>PTB250-2625-375-J1S</b>	
	-0.002	3.375	+0.004	0.688	0.375	0.03	0.5	<b>PTB375-2625-625-J1S</b>	
<b>2.75</b>	-0.001	3	+0.002	0.275	0.125	0.015	0.25	<b>PTB125-2750-250-J1S</b>	
	-0.001	3	+0.002	0.413	0.125	0.015	0.25	<b>PTB125-2750-375-J1S</b>	
	-0.001	3.125	+0.002	0.309	0.187	0.015	0.25	<b>PTB187-2750-281-J1S</b>	
	-0.001	3.125	+0.002	0.413	0.187	0.015	0.25	<b>PTB187-2750-375-J1S</b>	
	-0.002	3.25	+0.003	0.413	0.25	0.02	0.312	<b>PTB250-2750-375-J1S</b>	
	-0.002	3.25	+0.003	0.550	0.25	0.02	0.312	<b>PTB250-2750-500-J1S</b>	
	-0.002	3.375	+0.003	0.550	0.312	0.02	0.312	<b>PTB312-2750-500-J1S</b>	
	-0.002	3.5	+0.004	0.550	0.375	0.03	0.5	<b>PTB375-2750-500-J1S</b>	
	-0.002	3.5	+0.004	0.688	0.375	0.03	0.5	<b>PTB375-2750-625-J1S</b>	
	-0.003	3.75	+0.007	0.825	0.5	0.03	0.625	<b>PTB500-2750-750-J1S</b>	
	<b>2.875</b>	-0.001	3.25	+0.002	0.275	0.187	0.015	0.25	<b>PTB187-2875-250-J1S</b>
		-0.001	3.25	+0.002	0.293	0.187	0.015	0.25	<b>PTB187-2875-266-J1S</b>
-0.001		3.25	+0.002	0.413	0.187	0.015	0.25	<b>PTB187-2875-375-J1S</b>	
-0.002		3.375	+0.003	0.413	0.25	0.02	0.312	<b>PTB250-2875-375-J1S</b>	
-0.002		3.5	+0.003	0.550	0.312	0.02	0.312	<b>PTB312-2875-500-J1S</b>	
-0.002		3.625	+0.004	0.550	0.375	0.03	0.5	<b>PTB375-2875-500-J1S</b>	
-0.002		3.625	+0.004	0.688	0.375	0.03	0.5	<b>PTB375-2875-625-J1S</b>	
<b>3</b>		-0.001	3.25	+0.002	0.413	0.125	0.015	0.25	<b>PTB125-3000-375-J1S</b>
	-0.001	3.375	+0.002	0.343	0.187	0.015	0.25	<b>PTB187-3000-312-J1S</b>	
	-0.001	3.375	+0.002	0.413	0.187	0.015	0.25	<b>PTB187-3000-375-J1S</b>	
	-0.002	3.5	+0.003	0.413	0.25	0.02	0.312	<b>PTB250-3000-375-J1S</b>	
	-0.002	3.5	+0.003	0.550	0.25	0.02	0.312	<b>PTB250-3000-500-J1S</b>	
	-0.002	3.625	+0.003	0.413	0.312	0.02	0.312	<b>PTB312-3000-375-J1S</b>	
	-0.002	3.625	+0.003	0.550	0.312	0.02	0.312	<b>PTB312-3000-500-J1S</b>	
	-0.002	3.75	+0.004	0.550	0.375	0.03	0.5	<b>PTB375-3000-500-J1S</b>	
	-0.002	3.75	+0.004	0.688	0.375	0.03	0.5	<b>PTB375-3000-625-J1S</b>	
	-0.002	3.875	+0.004	0.759	0.437	0.03	0.5	<b>PTB437-3000-690-J1S</b>	

Cylinder dimensions								Designation
d	Tolerance	D	Tolerance	L +0.01	S	R max.	C min.	
in.								-
<b>3</b>	-0.003	4	+0.007	0.688	0.5	0.03	0.625	<b>PTB500-3000-625-J15</b>
	cont. -0.003	4	+0.007	0.825	0.5	0.03	0.625	<b>PTB500-3000-750-J15</b>
<b>3.125</b>	-0.001	3.5	+0.002	0.275	0.187	0.015	0.25	<b>PTB187-3125-250-J15</b>
	-0.001	3.5	+0.002	0.343	0.187	0.015	0.25	<b>PTB187-3125-312-J15</b>
	-0.001	3.5	+0.002	0.413	0.187	0.015	0.25	<b>PTB187-3125-375-J15</b>
	-0.002	3.625	+0.003	0.413	0.25	0.02	0.312	<b>PTB250-3125-375-J15</b>
	-0.002	3.75	+0.003	0.550	0.312	0.02	0.312	<b>PTB312-3125-500-J15</b>
	-0.002	3.875	+0.004	0.688	0.375	0.03	0.5	<b>PTB375-3125-625-J15</b>
<b>3.187</b>	-0.002	3.75	+0.003	0.550	0.281	0.02	0.312	<b>PTB281-3187-500-J15</b>
<b>3.25</b>	-0.001	3.625	+0.002	0.413	0.187	0.015	0.25	<b>PTB187-3250-375-J15</b>
	-0.002	3.75	+0.003	0.413	0.25	0.02	0.312	<b>PTB250-3250-375-J15</b>
	-0.002	3.75	+0.003	0.550	0.25	0.02	0.312	<b>PTB250-3250-500-J15</b>
	-0.002	3.875	+0.003	0.550	0.312	0.02	0.312	<b>PTB312-3250-500-J15</b>
	-0.002	4	+0.004	0.550	0.375	0.03	0.5	<b>PTB375-3250-500-J15</b>
	-0.002	4	+0.004	0.618	0.375	0.03	0.5	<b>PTB375-3250-562-J15</b>
	-0.002	4	+0.004	0.688	0.375	0.03	0.5	<b>PTB375-3250-625-J15</b>
	-0.003	4.25	+0.007	0.825	0.5	0.03	0.625	<b>PTB500-3250-750-J15</b>
	-0.003	4.5	+0.007	1.100	0.625	0.045	0.875	<b>PTB625-3250-1000-J15</b>
	<b>3.375</b>	-0.001	3.75	+0.002	0.275	0.187	0.015	0.25
-0.001		3.75	+0.002	0.413	0.187	0.015	0.25	<b>PTB187-3375-312-J15</b>
-0.002		3.875	+0.003	0.413	0.25	0.02	0.312	<b>PTB250-3375-375-J15</b>
-0.002		4	+0.003	0.550	0.312	0.02	0.312	<b>PTB312-3375-500-J15</b>
-0.002		4	+0.003	0.688	0.312	0.02	0.312	<b>PTB312-3375-625-J15</b>
-0.002		4.125	+0.004	0.688	0.375	0.03	0.5	<b>PTB375-3375-625-J15</b>
-0.003	4.375	+0.007	0.688	0.5	0.03	0.625	<b>PTB500-3375-625-J15</b>	
<b>3.437</b>	-0.002	4	+0.003	0.550	0.281	0.02	0.312	<b>PTB281-3437-500-J15</b>
<b>3.5</b>	-0.002	4	+0.003	0.413	0.25	0.02	0.312	<b>PTB250-3500-375-J15</b>
	-0.002	4	+0.003	0.550	0.25	0.02	0.312	<b>PTB250-3500-500-J15</b>
	-0.002	4.125	+0.003	0.550	0.312	0.02	0.312	<b>PTB312-3500-500-J15</b>
	-0.002	4.25	+0.004	0.688	0.375	0.03	0.5	<b>PTB375-3500-625-J15</b>
	-0.003	4.5	+0.007	0.825	0.5	0.03	0.625	<b>PTB500-3500-750-J15</b>
	-0.003	4.5	+0.007	1.100	0.625	0.045	0.875	<b>PTB625-3500-1000-J15</b>
<b>3.625</b>	-0.001	3.875	+0.002	0.206	0.125	0.015	0.25	<b>PTB125-3625-187-J15</b>
	-0.001	4	+0.002	0.275	0.187	0.015	0.25	<b>PTB187-3625-250-J15</b>
	-0.001	4	+0.002	0.413	0.187	0.015	0.25	<b>PTB187-3625-312-J15</b>
	-0.002	4.125	+0.003	0.413	0.25	0.02	0.312	<b>PTB250-3625-375-J15</b>
	-0.002	4.25	+0.003	0.413	0.312	0.02	0.312	<b>PTB312-3625-375-J15</b>
	-0.002	4.25	+0.003	0.550	0.312	0.02	0.312	<b>PTB312-3625-500-J15</b>
-0.002	4.375	+0.004	0.550	0.375	0.03	0.5	<b>PTB375-3625-500-J15</b>	
-0.002	4.375	+0.004	0.688	0.375	0.03	0.5	<b>PTB375-3625-625-J15</b>	
<b>3.75</b>	-0.001	4	+0.002	0.275	0.125	0.015	0.25	<b>PTB125-3750-250-J15</b>
	-0.001	4.125	+0.002	0.413	0.187	0.015	0.25	<b>PTB187-3750-312-J15</b>
	-0.002	4.25	+0.003	0.413	0.25	0.02	0.312	<b>PTB250-3750-375-J15</b>
	-0.002	4.25	+0.003	0.550	0.25	0.02	0.312	<b>PTB250-3750-500-J15</b>
	-0.002	4.25	+0.003	0.618	0.25	0.02	0.312	<b>PTB250-3750-562-J15</b>
	-0.002	4.375	+0.003	0.413	0.312	0.02	0.312	<b>PTB312-3750-375-J15</b>
	-0.002	4.375	+0.003	0.550	0.312	0.02	0.312	<b>PTB312-3750-500-J15</b>
	-0.002	4.375	+0.003	0.688	0.312	0.02	0.312	<b>PTB312-3750-625-J15</b>
	-0.002	4.5	+0.004	0.688	0.375	0.03	0.5	<b>PTB375-3750-625-J15</b>
	-0.003	4.75	+0.007	0.759	0.5	0.03	0.625	<b>PTB500-3750-690-J15</b>
-0.003	5	+0.007	1.100	0.625	0.045	0.875	<b>PTB625-3750-1000-J15</b>	

3.4

### 3.4 PTB profile rod seals, inch sizes d 3.875 – 5.25 in.

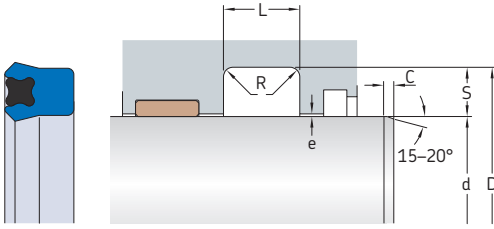

#### Maximum extrusion gap e

Radial depth	$e_{max}$ at 60 °C (140 °F) for pressures		
	2 300 psi	3 600 psi	5 800 psi
S			
in.	in.		
<b>0.125</b>	0.008	0.004	–
<b>0.156 to 0.187</b>	0.014	0.008	–
<b>0.218 to 0.25</b>	0.018	0.010	0.004
<b>0.281 to 0.437</b>	0.020	0.012	0.006
<b>0.5 to 0.562</b>	0.024	0.012	0.008
<b>0.625 to 0.75</b>	0.024	0.012	0.008

#### Cylinder dimensions

#### Designation

d	Tolerance	D	Tolerance	L	S	R	C	Designation
				+0.01		max.	min.	
in.								–
<b>3.875</b>	-0.001	4.25	+0.002	0.413	0.187	0.015	0.25	<b>PTB187-3875-375-J15</b>
	-0.002	4.375	+0.003	0.413	0.25	0.02	0.312	<b>PTB250-3875-375-J15</b>
	-0.002	4.5	+0.003	0.550	0.312	0.02	0.312	<b>PTB312-3875-500-J15</b>
	-0.002	4.625	+0.004	0.688	0.375	0.03	0.5	<b>PTB375-3875-625-J15</b>
	-0.002	4.75	+0.004	0.825	0.437	0.03	0.5	<b>PTB437-3875-750-J15</b>
<b>4</b>	-0.001	4.375	+0.002	0.413	0.187	0.015	0.25	<b>PTB187-4000-375-J15</b>
	-0.002	4.5	+0.003	0.343	0.25	0.02	0.312	<b>PTB250-4000-312-J15</b>
	-0.002	4.5	+0.003	0.413	0.25	0.02	0.312	<b>PTB250-4000-375-J15</b>
	-0.002	4.5	+0.003	0.550	0.25	0.02	0.312	<b>PTB250-4000-500-J15</b>
	-0.002	4.5	+0.003	0.618	0.25	0.02	0.312	<b>PTB250-4000-562-J15</b>
	-0.002	4.625	+0.003	0.618	0.312	0.02	0.312	<b>PTB312-4000-562-J15</b>
	-0.002	4.75	+0.004	0.550	0.375	0.03	0.5	<b>PTB375-4000-500-J15</b>
	-0.002	4.75	+0.004	0.688	0.375	0.03	0.5	<b>PTB375-4000-625-J15</b>
	-0.002	4.875	+0.004	0.825	0.437	0.03	0.5	<b>PTB437-4000-750-J15</b>
	-0.003	5	+0.007	0.688	0.5	0.03	0.625	<b>PTB500-4000-625-J15</b>
	-0.003	5	+0.007	0.825	0.5	0.03	0.625	<b>PTB500-4000-750-J15</b>
	-0.003	5.124	+0.007	0.825	0.562	0.03	0.75	<b>PTB562-4000-750-J15</b>
	<b>4.125</b>	-0.001	4.5	+0.002	0.413	0.187	0.015	0.25
-0.002		4.625	+0.003	0.413	0.25	0.02	0.312	<b>PTB250-4125-375-J15</b>
-0.002		4.625	+0.003	0.618	0.25	0.02	0.312	<b>PTB250-4125-562-J15</b>
-0.002		4.75	+0.003	0.550	0.312	0.02	0.312	<b>PTB312-4125-500-J15</b>
-0.002		4.75	+0.003	0.618	0.312	0.02	0.312	<b>PTB312-4125-562-J15</b>
<b>4.25</b>	-0.001	4.625	+0.002	0.413	0.187	0.015	0.25	<b>PTB187-4250-375-J15</b>
	-0.002	4.75	+0.003	0.413	0.25	0.02	0.312	<b>PTB250-4250-375-J15</b>
	-0.002	4.75	+0.003	0.618	0.25	0.02	0.312	<b>PTB250-4250-562-J15</b>
	-0.002	4.875	+0.003	0.481	0.312	0.02	0.312	<b>PTB312-4250-437-J15</b>
	-0.002	4.875	+0.003	0.618	0.312	0.02	0.312	<b>PTB312-4250-562-J15</b>
	-0.002	5	+0.004	0.550	0.375	0.03	0.5	<b>PTB375-4250-500-J15</b>
	-0.002	5	+0.004	0.688	0.375	0.03	0.5	<b>PTB375-4250-625-J15</b>
	-0.003	5.25	+0.007	0.825	0.5	0.03	0.625	<b>PTB500-4250-750-J15</b>
	-0.003	5.5	+0.007	1.100	0.625	0.045	0.875	<b>PTB625-4250-1000-J15</b>
	-0.003	5.5	+0.007	0.825	0.625	0.045	0.875	<b>PTB625-4250-750-J15</b>

Cylinder dimensions								Designation
d	Tolerance	D	Tolerance	L +0.01	S	R max.	C min.	
in.								-
4.375	-0.001	4.75	+0.002	0.413	0.187	0.015	0.25	PTB187-4375-375-J15
	-0.002	4.875	+0.003	0.618	0.25	0.02	0.312	PTB250-4375-562-J15
	-0.002	5	+0.003	0.550	0.312	0.02	0.312	PTB312-4375-500-J15
	-0.002	5	+0.003	0.618	0.312	0.02	0.312	PTB312-4375-562-J15
	-0.002	5.125	+0.004	0.550	0.375	0.03	0.5	PTB375-4375-500-J15
	-0.002	5.125	+0.004	0.688	0.375	0.03	0.5	PTB375-4375-625-J15
	-0.003	5.375	+0.007	0.825	0.5	0.03	0.625	PTB500-4375-750-J15
	-0.001	4.75	+0.002	0.206	0.125	0.015	0.25	PTB125-4500-187-J15
	-0.001	4.875	+0.002	0.343	0.187	0.015	0.25	PTB187-4500-312-J15
	-0.001	4.875	+0.002	0.413	0.187	0.015	0.25	PTB187-4500-375-J15
-0.002	5	+0.003	0.343	0.25	0.02	0.312	PTB250-4500-312-J15	
-0.002	5	+0.003	0.413	0.25	0.02	0.312	PTB250-4500-375-J15	
-0.002	5	+0.003	0.550	0.25	0.02	0.312	PTB250-4500-500-J15	
-0.002	5	+0.003	0.618	0.25	0.02	0.312	PTB250-4500-562-J15	
-0.002	5	+0.003	0.688	0.25	0.02	0.312	PTB250-4500-625-J15	
-0.002	5.125	+0.003	0.550	0.312	0.02	0.312	PTB312-4500-500-J15	
-0.002	5.125	+0.003	0.688	0.312	0.02	0.312	PTB312-4500-625-J15	
-0.002	5.25	+0.004	0.688	0.375	0.03	0.5	PTB375-4500-625-J15	
-0.002	5.375	+0.004	0.825	0.437	0.03	0.5	PTB437-4500-750-J15	
4.625	-0.002	5.125	+0.003	0.618	0.25	0.02	0.312	PTB250-4625-562-J15
	-0.002	5.25	+0.003	0.688	0.312	0.02	0.312	PTB312-4625-625-J15
	-0.002	5.375	+0.004	0.688	0.375	0.03	0.5	PTB375-4625-625-J15
4.75	-0.001	5	+0.002	0.275	0.125	0.015	0.25	PTB125-4750-250-J15
	-0.001	5.125	+0.002	0.413	0.187	0.015	0.25	PTB187-4750-375-J15
	-0.002	5.25	+0.003	0.413	0.25	0.02	0.312	PTB250-4750-375-J15
	-0.002	5.25	+0.003	0.618	0.25	0.02	0.312	PTB250-4750-562-J15
	-0.002	5.375	+0.003	0.550	0.312	0.02	0.312	PTB312-4750-500-J15
	-0.002	5.375	+0.003	0.688	0.312	0.02	0.312	PTB312-4750-625-J15
	-0.002	5.5	+0.004	0.550	0.375	0.03	0.5	PTB375-4750-500-J15
	-0.002	5.5	+0.004	0.688	0.375	0.03	0.5	PTB375-4750-625-J15
	-0.002	5.625	+0.004	0.825	0.437	0.03	0.5	PTB437-4750-750-J15
	-0.003	5.75	+0.007	0.759	0.5	0.03	0.625	PTB500-4750-690-J15
4.875	-0.002	5.375	+0.003	0.618	0.25	0.02	0.312	PTB250-4875-562-J15
	-0.002	5.375	+0.003	0.688	0.25	0.02	0.312	PTB250-4875-625-J15
	-0.002	5.625	+0.004	0.688	0.375	0.03	0.5	PTB375-4875-625-J15
5	-0.001	5.25	+0.002	0.275	0.125	0.015	0.25	PTB125-5000-250-J15
	-0.001	5.375	+0.002	0.413	0.187	0.015	0.25	PTB187-5000-375-J15
	-0.002	5.5	+0.003	0.413	0.25	0.02	0.312	PTB250-5000-375-J15
	-0.002	5.5	+0.003	0.550	0.25	0.02	0.312	PTB250-5000-500-J15
	-0.002	5.5	+0.003	0.618	0.25	0.02	0.312	PTB250-5000-562-J15
	-0.002	5.625	+0.003	0.688	0.312	0.02	0.312	PTB312-5000-625-J15
	-0.002	5.75	+0.004	0.550	0.375	0.03	0.5	PTB375-5000-500-J15
	-0.002	5.75	+0.004	0.688	0.375	0.03	0.5	PTB375-5000-625-J15
	-0.003	6	+0.007	0.688	0.5	0.03	0.625	PTB500-5000-625-J15
	-0.003	6	+0.007	0.825	0.5	0.03	0.625	PTB500-5000-750-J15
-0.003	6.25	+0.007	1.100	0.625	0.045	0.875	PTB625-5000-1000-J15	
5.125	-0.002	5.875	+0.004	0.688	0.375	0.03	0.5	PTB375-5125-625-J15
5.25	-0.001	5.625	+0.002	0.413	0.187	0.015	0.25	PTB187-5250-375-J15
	-0.002	5.75	+0.003	0.413	0.25	0.02	0.312	PTB250-5250-375-J15
	-0.002	5.75	+0.003	0.618	0.25	0.02	0.312	PTB250-5250-562-J15
	-0.002	5.875	+0.003	0.688	0.312	0.02	0.312	PTB312-5250-625-J15

3.4

### 3.4 PTB profile rod seals, inch sizes d 5.25 – 7.5 in.

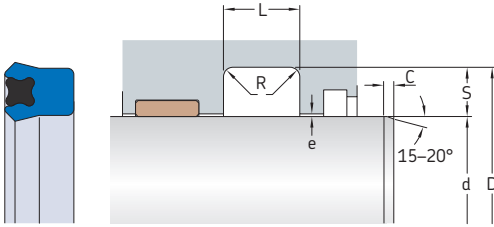

#### Maximum extrusion gap e

Radial depth	$e_{\max}$ at 60 °C (140 °F) for pressures		
	2 300 psi	3 600 psi	5 800 psi
S			
in.	in.		
<b>0.125</b>	0.008	0.004	–
<b>0.156 to 0.187</b>	0.014	0.008	–
<b>0.218 to 0.25</b>	0.018	0.010	0.004
<b>0.281 to 0.437</b>	0.020	0.012	0.006
<b>0.5 to 0.562</b>	0.024	0.012	0.008
<b>0.625 to 0.75</b>	0.024	0.012	0.008

#### Cylinder dimensions

#### Designation

d	Tolerance	D	Tolerance	L	S	R	C
				+0.01		max.	min.
in.							–

5.25  
cont.



Cylinder dimensions								Designation	
d	Tolerance	D	Tolerance	L +0.01	S	R max.	C min.		
in.								-	
6	-0.001	6.375	+0.002	0.413	0.187	0.015	0.25	PTB187-6000-375-J15	
	-0.002	6.5	+0.003	0.413	0.25	0.02	0.312	PTB250-6000-375-J15	
	-0.002	6.5	+0.003	0.481	0.25	0.02	0.312	PTB250-6000-437-J15	
	-0.002	6.5	+0.003	0.618	0.25	0.02	0.312	PTB250-6000-562-J15	
	-0.002	6.625	+0.003	0.688	0.312	0.02	0.312	PTB312-6000-625-J15	
	-0.002	6.75	+0.004	0.550	0.375	0.03	0.5	PTB375-6000-500-J15	
	-0.002	6.75	+0.004	0.618	0.375	0.03	0.5	PTB375-6000-562-J15	
	-0.002	6.75	+0.004	0.688	0.375	0.03	0.5	PTB375-6000-625-J15	
	-0.003	7	+0.007	0.825	0.5	0.03	0.625	PTB500-6000-750-J15	
	6.125	-0.002	6.625	+0.003	0.413	0.25	0.02	0.312	PTB250-6125-375-J15
6.25	-0.001	6.625	+0.002	0.343	0.187	0.015	0.25	PTB187-6250-312-J15	
	-0.002	6.75	+0.003	0.413	0.25	0.02	0.312	PTB250-6250-375-J15	
	-0.002	7	+0.004	0.550	0.375	0.03	0.5	PTB375-6250-500-J15	
	-0.002	7	+0.004	0.688	0.375	0.03	0.5	PTB375-6250-625-J15	
	-0.003	7.25	+0.007	0.825	0.5	0.03	0.625	PTB500-6250-750-J15	
	-0.003	7.5	+0.007	1.100	0.625	0.045	0.875	PTB625-6250-1000-J15	
6.375	-0.002	7	+0.003	0.688	0.312	0.02	0.312	PTB312-6375-625-J15	
6.5	-0.002	7	+0.003	0.413	0.25	0.02	0.312	PTB250-6500-375-J15	
	-0.002	7	+0.003	0.618	0.25	0.02	0.312	PTB250-6500-562-J15	
	-0.002	7.125	+0.003	0.688	0.312	0.02	0.312	PTB312-6500-625-J15	
	-0.002	7.25	+0.004	0.550	0.375	0.03	0.5	PTB375-6500-500-J15	
	-0.002	7.25	+0.004	0.688	0.375	0.03	0.5	PTB375-6500-625-J15	
	-0.003	7.5	+0.007	0.825	0.5	0.03	0.625	PTB500-6500-750-J15	
6.625	-0.002	7.25	+0.003	0.688	0.312	0.02	0.312	PTB312-6625-625-J15	
6.75	-0.002	7.25	+0.003	0.413	0.25	0.02	0.312	PTB250-6750-375-J15	
	-0.002	7.25	+0.003	0.618	0.25	0.02	0.312	PTB250-6750-562-J15	
	-0.002	7.5	+0.004	0.550	0.375	0.03	0.5	PTB375-6750-500-J15	
	-0.002	7.5	+0.004	0.688	0.375	0.03	0.5	PTB375-6750-625-J15	
	-0.003	7.75	+0.007	0.825	0.5	0.03	0.625	PTB500-6750-750-J15	
6.875	-0.002	7.625	+0.004	0.688	0.375	0.03	0.5	PTB375-6875-625-J15	
7	-0.002	7.5	+0.003	0.413	0.25	0.02	0.312	PTB250-7000-375-J15	
	-0.002	7.5	+0.003	0.618	0.25	0.02	0.312	PTB250-7000-562-J15	
	-0.002	7.625	+0.003	0.688	0.312	0.02	0.312	PTB312-7000-625-J15	
	-0.002	7.75	+0.004	0.550	0.375	0.03	0.5	PTB375-7000-500-J15	
	-0.002	7.75	+0.004	0.688	0.375	0.03	0.5	PTB375-7000-625-J15	
	-0.003	8	+0.007	0.825	0.5	0.03	0.625	PTB500-7000-750-J15	
	-0.003	8.25	+0.007	1.100	0.625	0.045	0.875	PTB625-7000-1000-J15	
	-0.003	8.25	+0.007	0.825	0.625	0.045	0.875	PTB625-7000-750-J15	
	7.125	-0.002	7.625	+0.003	0.618	0.25	0.02	0.312	PTB250-7125-562-J15
	7.25	-0.002	7.75	+0.003	0.618	0.25	0.02	0.312	PTB250-7250-562-J15
-0.002		7.875	+0.003	0.688	0.312	0.02	0.312	PTB312-7250-625-J15	
-0.002		8	+0.004	0.688	0.375	0.03	0.5	PTB375-7250-625-J15	
-0.003		8.25	+0.007	0.825	0.5	0.03	0.625	PTB500-7250-750-J15	
7.375	-0.002	8	+0.003	0.688	0.312	0.02	0.312	PTB312-7375-625-J15	
7.5	-0.001	7.875	+0.002	0.343	0.187	0.015	0.25	PTB187-7500-312-J15	
	-0.002	8	+0.003	0.413	0.25	0.02	0.312	PTB250-7500-375-J15	
	-0.002	8	+0.003	0.618	0.25	0.02	0.312	PTB250-7500-562-J15	
	-0.002	8.25	+0.004	0.550	0.375	0.03	0.5	PTB375-7500-500-J15	
	-0.002	8.25	+0.004	0.688	0.375	0.03	0.5	PTB375-7500-625-J15	
	-0.002	8.375	+0.004	0.550	0.437	0.03	0.5	PTB437-7500-500-J15	
	-0.003	8.75	+0.007	1.100	0.625	0.045	0.875	PTB625-7500-1000-J15	

### 3.4 PTB profile rod seals, inch sizes d 7.75 – 14.375 in.

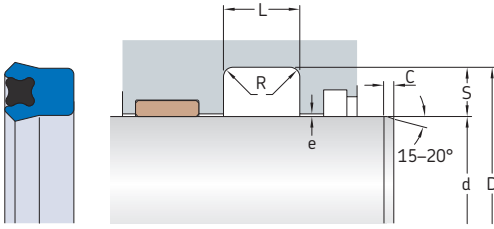

#### Maximum extrusion gap e

Radial depth	e <sub>max</sub> at 60 °C (140 °F) for pressures		
	2 300 psi	3 600 psi	5 800 psi
S			
in.	in.		
<b>0.125</b>	0.008	0.004	–
<b>0.156 to 0.187</b>	0.014	0.008	–
<b>0.218 to 0.25</b>	0.018	0.010	0.004
<b>0.281 to 0.437</b>	0.020	0.012	0.006
<b>0.5 to 0.562</b>	0.024	0.012	0.008
<b>0.625 to 0.75</b>	0.024	0.012	0.008

#### Cylinder dimensions

#### Designation

d	Tolerance	D	Tolerance	L +0.01	S	R max.	C min.	Designation
in.								–
7.75	-0.002	8.25	+0.003	0.618	0.25	0.02	0.312	PTB250-7750-562-J15
	-0.002	8.5	+0.004	0.550	0.375	0.03	0.5	PTB375-7750-500-J15
	-0.002	8.5	+0.004	0.688	0.375	0.03	0.5	PTB375-7750-625-J15
	-0.003	8.75	+0.007	0.825	0.5	0.03	0.625	PTB500-7750-750-J15
8	-0.002	8.5	+0.003	0.618	0.25	0.02	0.312	PTB250-8000-562-J15
	-0.002	8.625	+0.003	0.688	0.312	0.02	0.312	PTB312-8000-625-J15
	-0.002	8.75	+0.004	0.688	0.375	0.03	0.5	PTB375-8000-625-J15
	-0.003	9	+0.007	0.825	0.5	0.03	0.625	PTB500-8000-750-J15
	-0.003	9.5	+0.007	1.375	0.75	0.045	1	PTB750-8000-1250-J15
8.125	-0.002	8.625	+0.003	0.618	0.25	0.02	0.312	PTB250-8125-562-J15
8.25	-0.002	8.75	+0.003	0.618	0.25	0.02	0.312	PTB250-8250-562-J15
	-0.002	9	+0.004	0.688	0.375	0.03	0.5	PTB375-8250-625-J15
	-0.003	9.5	+0.007	1.100	0.625	0.045	0.875	PTB625-8250-1000-J15
8.375	-0.002	8.875	+0.003	0.618	0.25	0.02	0.312	PTB250-8375-562-J15
8.5	-0.002	9	+0.003	0.618	0.25	0.02	0.312	PTB250-8500-562-J15
	-0.002	9.25	+0.004	0.550	0.375	0.03	0.5	PTB375-8500-500-J15
	-0.002	9.25	+0.004	0.688	0.375	0.03	0.5	PTB375-8500-625-J15
	-0.002	9.312	+0.004	0.550	0.406	0.03	0.5	PTB406-8500-500-J15
	-0.003	9.5	+0.007	0.825	0.5	0.03	0.625	PTB500-8500-750-J15
	-0.003	9.75	+0.007	1.100	0.625	0.045	0.875	PTB625-8500-1000-J15
	-0.003	10	+0.007	1.238	0.75	0.045	1	PTB750-8500-1125-J15
8.75	-0.002	9.5	+0.004	0.550	0.375	0.03	0.5	PTB375-8750-500-J15
9	-0.002	9.5	+0.003	0.618	0.25	0.02	0.312	PTB250-9000-562-J15
	-0.002	9.75	+0.004	0.688	0.375	0.03	0.5	PTB375-9000-625-J15
	-0.003	10	+0.007	0.825	0.5	0.03	0.625	PTB500-9000-750-J15
	-0.003	10.5	+0.007	1.375	0.75	0.045	1	PTB750-9000-1250-J15
	-0.003	10.5	+0.007	1.650	0.75	0.045	1	PTB750-9000-1500-J15
9.25	-0.002	9.875	+0.003	0.688	0.312	0.02	0.312	PTB312-9250-625-J15
	-0.002	10	+0.004	0.688	0.375	0.03	0.5	PTB375-9250-625-J15
	-0.003	10.25	+0.007	0.825	0.5	0.03	0.625	PTB500-9250-750-J15

Cylinder dimensions								Designation
d	Tolerance	D	Tolerance	L +0.01	S	R max.	C min.	
in.								-
9.5	-0.002	10	+0.003	0.618	0.25	0.02	0.312	PTB250-9500-562-J1S
	-0.002	10.25	+0.004	0.688	0.375	0.03	0.5	PTB375-9500-625-J1S
	-0.003	10.5	+0.007	0.825	0.5	0.03	0.625	PTB500-9500-750-J1S
9.625	-0.002	10.125	+0.003	0.413	0.25	0.02	0.312	PTB250-9625-375-J1S
9.75	-0.002	10.5	+0.004	0.688	0.375	0.03	0.5	PTB375-9750-625-J1S
	-0.003	10.75	+0.007	0.825	0.5	0.03	0.625	PTB500-9750-750-J1S
10	-0.002	10.5	+0.003	0.618	0.25	0.02	0.312	PTB250-10000-562-J1S
	-0.002	10.75	+0.004	0.688	0.375	0.03	0.5	PTB375-10000-625-J1S
	-0.003	11	+0.007	0.825	0.5	0.03	0.625	PTB500-10000-750-J1S
	-0.003	11.25	+0.007	1.100	0.625	0.045	0.875	PTB625-10000-1000-J1S
10.25	-0.003	11.5	+0.007	1.375	0.75	0.045	1	PTB750-10000-1250-J1S
	-0.002	11	+0.004	0.550	0.375	0.03	0.5	PTB375-10250-500-J1S
10.5	-0.002	11.25	+0.004	0.688	0.375	0.03	0.5	PTB375-10500-625-J1S
	-0.003	11.5	+0.007	1.100	0.5	0.03	0.625	PTB500-10500-1000-J1S
	-0.003	11.5	+0.007	0.825	0.5	0.03	0.625	PTB500-10500-750-J1S
	-0.003	12	+0.007	1.100	0.75	0.045	1	PTB750-10500-1000-J1S
10.625	-0.003	11.625	+0.007	0.825	0.5	0.03	0.625	PTB500-10625-750-J1S
10.75	-0.002	11.5	+0.004	0.688	0.375	0.03	0.5	PTB375-10750-625-J1S
	-0.003	11.75	+0.007	0.825	0.5	0.03	0.625	PTB500-10750-750-J1S
11	-0.002	11.75	+0.004	0.688	0.375	0.03	0.5	PTB375-11000-625-J1S
	-0.003	12	+0.007	0.825	0.5	0.03	0.625	PTB500-11000-750-J1S
	-0.003	12.25	+0.007	1.100	0.625	0.045	0.875	PTB625-11000-1000-J1S
11.25	-0.002	12	+0.004	0.688	0.375	0.03	0.5	PTB375-11250-625-J1S
	-0.003	12.5	+0.007	1.100	0.625	0.045	0.875	PTB625-11250-1000-J1S
11.5	-0.002	12	+0.003	0.584	0.25	0.02	0.312	PTB250-11500-531-J1S
	-0.002	12.25	+0.004	0.688	0.375	0.03	0.5	PTB375-11500-625-J1S
	-0.003	12.75	+0.007	1.100	0.625	0.045	0.875	PTB625-11500-1000-J1S
11.75	-0.003	12.75	+0.007	0.825	0.5	0.03	0.625	PTB500-11750-750-J1S
12	-0.002	12.5	+0.003	0.618	0.25	0.02	0.312	PTB250-12000-562-J1S
	-0.003	13	+0.007	0.825	0.5	0.03	0.625	PTB500-12000-750-J1S
	-0.003	13.5	+0.007	1.375	0.75	0.045	1	PTB750-12000-1250-J1S
12.25	-0.003	13.5	+0.007	1.100	0.625	0.045	0.875	PTB625-12250-1000-J1S
	-0.002	13	+0.003	0.584	0.25	0.02	0.312	PTB250-12500-531-J1S
	-0.003	13.5	+0.007	0.825	0.5	0.03	0.625	PTB500-12500-750-J1S
12.75	-0.002	13.25	+0.003	0.618	0.25	0.02	0.312	PTB250-12750-562-J1S
	-0.002	13.5	+0.004	0.688	0.375	0.03	0.5	PTB375-12750-625-J1S
	-0.003	13.75	+0.007	0.825	0.5	0.03	0.625	PTB500-12750-750-J1S
13	-0.003	14	+0.007	0.825	0.5	0.03	0.625	PTB500-13000-750-J1S
13.5	-0.002	14	+0.003	0.584	0.25	0.02	0.312	PTB250-13500-531-J1S
	-0.002	14	+0.003	0.618	0.25	0.02	0.312	PTB250-13500-562-J1S
	-0.003	14.75	+0.007	0.963	0.625	0.045	0.875	PTB625-13500-875-J1S
13.625	-0.002	14.375	+0.004	0.688	0.375	0.03	0.5	PTB375-13625-625-J1S
14	-0.003	15	+0.007	0.825	0.5	0.03	0.625	PTB500-14000-750-J1S
	-0.003	15.5	+0.007	1.375	0.75	0.045	1	PTB750-14000-1250-J1S
14.25	-0.002	15	+0.004	0.688	0.375	0.03	0.5	PTB375-14250-625-J1S
	-0.003	15.75	+0.007	1.375	0.75	0.045	1	PTB750-14250-1250-J1S
14.375	-0.002	15.125	+0.004	0.688	0.375	0.03	0.5	PTB375-14375-625-J1S

### 3.4 PTB profile rod seals, inch sizes d 14.5 – 35 in.

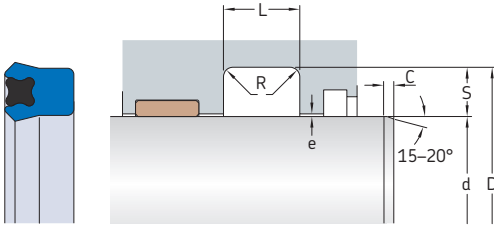

#### Maximum extrusion gap e

Radial depth	$e_{\max}$ at 60 °C (140 °F) for pressures		
	2 300 psi	3 600 psi	5 800 psi
S			
in.	in.		
<b>0.125</b>	0.008	0.004	–
<b>0.156 to 0.187</b>	0.014	0.008	–
<b>0.218 to 0.25</b>	0.018	0.010	0.004
<b>0.281 to 0.437</b>	0.020	0.012	0.006
<b>0.5 to 0.562</b>	0.024	0.012	0.008
<b>0.625 to 0.75</b>	0.024	0.012	0.008

#### Cylinder dimensions

#### Designation

d	Tolerance	D	Tolerance	L +0.01	S	R max.	C min.	Designation
in.								–
14.5	-0.003	16	+0.007	1.238	0.75	0.045	1	PTB750-14500-1125-J15
14.75	-0.002 -0.003	15.5 16	+0.004 +0.007	0.688 1.100	0.375 0.625	0.03 0.045	0.5 0.875	PTB375-14750-625-J15 PTB625-14750-1000-J15
15	-0.003	16	+0.007	0.825	0.5	0.03	0.625	PTB500-15000-750-J15
15.25	-0.002	16	+0.004	0.688	0.375	0.03	0.5	PTB375-15250-625-J15
15.5	-0.003	16.75	+0.007	1.100	0.625	0.045	0.875	PTB625-15500-1000-J15
15.75	-0.003	16.75	+0.007	0.825	0.5	0.03	0.625	PTB500-15750-750-J15
16	-0.003 -0.003 -0.003	17 17.25 17.5	+0.007 +0.007 +0.007	0.825 1.238 1.375	0.5 0.625 0.75	0.03 0.045 0.045	0.625 0.875 1	PTB500-16000-750-J15 PTB625-16000-1125-J15 PTB750-16000-1250-J15
16.5	-0.003	17.5	+0.007	0.825	0.5	0.03	0.625	PTB500-16500-750-J15
17	-0.003	18	+0.007	0.825	0.5	0.03	0.625	PTB500-17000-750-J15
18	-0.003 -0.003	19 19.25	+0.007 +0.007	0.825 1.100	0.5 0.625	0.03 0.045	0.625 0.875	PTB500-18000-750-J15 PTB625-18000-1000-J15
18.5	-0.003	20	+0.007	1.375	0.75	0.045	1	PTB750-18500-1250-J15
18.75	-0.003	20	+0.007	1.100	0.625	0.045	0.875	PTB625-18750-1000-J15
19	-0.003	20	+0.007	0.825	0.5	0.03	0.625	PTB500-19000-750-J15
20	-0.003	21.5	+0.007	1.375	0.75	0.045	1	PTB750-20000-1250-J15
21	-0.003	22	+0.007	0.825	0.5	0.03	0.625	PTB500-21000-750-J15
22.5	-0.003	24	+0.007	1.100	0.75	0.045	1	PTB750-22500-1000-J15
23	-0.003	24	+0.007	0.825	0.5	0.03	0.625	PTB500-23000-750-J15
24.5	-0.003	25.5	+0.007	0.825	0.5	0.03	0.625	PTB500-24500-750-J15
25.5	-0.003	26.5	+0.007	0.825	0.5	0.03	0.625	PTB500-25500-750-J15

Cylinder dimensions								Designation
d	Tolerance	D	Tolerance	L +0.01	S	R max.	C min.	
in.								-
30.75	-0.003	32	+0.007	1.100	0.625	0.045	0.875	PTB625-30750-1000-J1S
35	-0.002	35.75	+0.004	0.688	0.375	0.03	0.5	PTB375-35000-625-J1S

Other sizes are available on request

## STD profile data



<b>Materials</b>	Sealing ring: TPU 95A, U-1003 X-ring: NBR 70A, A-8501 For additional information → <b>page 26</b>
<b>Pressure</b>	Up to 400 bar (5 800 psi)
<b>Speed</b>	Up to 1 m/s (3.2 ft/s)
<b>Temperature range</b>	<div style="display: flex; align-items: center;"> <div style="margin-right: 10px;"> <p>-50   -40   -30</p> <p>-60   -40   -20</p> </div> <div style="margin-left: 10px;"> <p>100   110   120 [°C]</p> <p>210   230   250 [°F]</p> </div> </div> <ul style="list-style-type: none"> <li><span style="display: inline-block; width: 15px; height: 15px; background-color: #0070C0; margin-right: 5px;"></span> Extreme low temperature range: may be intermittently exposed (e.g. cold start-up) without seal damage, but seal performance may be compromised while in this range</li> <li><span style="display: inline-block; width: 15px; height: 15px; background-color: #808080; margin-right: 5px;"></span> Temperatures below the recommended operating range: seal performance depends on system design (precision guiding arrangement recommended)</li> <li><span style="display: inline-block; width: 15px; height: 15px; background-color: #00A651; margin-right: 5px;"></span> <b>Recommended operating temperature range for this profile and material</b></li> <li><span style="display: inline-block; width: 15px; height: 15px; background-color: #FFD700; margin-right: 5px;"></span> Temperatures above the recommended operating range: acceptable only with reduced pressure, speed, e-gap and/or with the use of a full-face anti-extrusion ring</li> <li><span style="display: inline-block; width: 15px; height: 15px; background-color: #FF0000; margin-right: 5px;"></span> Extreme high temperature range: only occasional short term exposure (e.g. cylinder in curing oven of a powder coating process)</li> </ul>
<b>Counter-surface</b>	→ <b>page 22</b>

Maximum values of application parameters (e.g. pressure, speed, temperature, e-gap) should not be applied continuously nor simultaneously.

### 3.5 STD profile rod seals, inch sizes d 0.125 – 0.562 in.

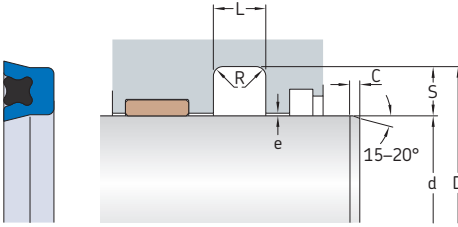

#### Maximum extrusion gap e

Radial depth	$e_{max}$ at 60 °C (140 °F) for pressures		
	2 300 psi	3 600 psi	5 800 psi
S			
in.	in.		
<b>0.125</b>	0.008	0.004	–
<b>0.156 to 0.187</b>	0.014	0.008	–
<b>0.218 to 0.25</b>	0.018	0.010	0.004
<b>0.281 to 0.437</b>	0.020	0.012	0.006
<b>0.5 to 0.562</b>	0.024	0.012	0.008
<b>0.625 to 0.75</b>	0.024	0.012	0.008

#### Cylinder dimensions

#### Designation

d	Tolerance	D	Tolerance	L +0.01	S	R max.	C min.	Designation
in.								–
<b>0.125</b>	–0.001	0.375	+0.002	0.138	0.125	0.015	0.25	<b>STD125-125-125-J1S</b>
<b>0.14</b>	–0.001	0.39	+0.002	0.138	0.125	0.015	0.25	<b>STD125-140-125-J1S</b>
<b>0.156</b>	–0.001	0.406	+0.002	0.138	0.125	0.015	0.25	<b>STD125-156-125-J1S</b>
<b>0.187</b>	–0.001 –0.001	0.437 0.561	+0.002 +0.002	0.138 0.206	0.125 0.187	0.015 0.015	0.25 0.25	<b>STD125-187-125-J1S</b> <b>STD187-187-187-J1S</b>
<b>0.25</b>	–0.001 –0.001 –0.002 –0.002	0.5 0.624 0.75 0.874	+0.002 +0.002 +0.003 +0.003	0.138 0.206 0.275 0.343	0.125 0.187 0.25 0.312	0.015 0.015 0.02 0.02	0.25 0.25 0.312 0.312	<b>STD125-250-125-J1S</b> <b>STD187-250-187-J1S</b> <b>STD250-250-250-J1S</b> <b>STD312-250-312-J1S</b>
<b>0.312</b>	–0.001 –0.001 –0.002 –0.002	0.562 0.686 0.748 0.812	+0.002 +0.002 +0.003 +0.003	0.138 0.206 0.240 0.275	0.125 0.187 0.218 0.25	0.015 0.015 0.015 0.02	0.25 0.25 0.25 0.312	<b>STD125-312-125-J1S</b> <b>STD187-312-187-J1S</b> <b>STD218-312-218-J1S</b> <b>STD250-312-250-J1S</b>
<b>0.375</b>	–0.001 –0.001 –0.002 –0.002	0.625 0.749 0.875 0.999	+0.002 +0.002 +0.003 +0.003	0.138 0.206 0.275 0.343	0.125 0.187 0.25 0.312	0.015 0.015 0.02 0.02	0.25 0.25 0.312 0.312	<b>STD125-375-125-J1S</b> <b>STD187-375-187-J1S</b> <b>STD250-375-250-J1S</b> <b>STD312-375-312-J1S</b>
<b>0.437</b>	–0.001 –0.001 –0.002 –0.002	0.687 0.811 0.937 1.061	+0.002 +0.002 +0.003 +0.003	0.138 0.206 0.275 0.343	0.125 0.187 0.25 0.312	0.015 0.015 0.02 0.02	0.25 0.25 0.312 0.312	<b>STD125-437-125-J1S</b> <b>STD187-437-187-J1S</b> <b>STD250-437-250-J1S</b> <b>STD312-437-312-J1S</b>
<b>0.5</b>	–0.001 –0.001 –0.001 –0.002 –0.002 –0.002	0.75 0.812 0.874 1 1.124 1.25	+0.002 +0.002 +0.002 +0.003 +0.003 +0.004	0.138 0.172 0.206 0.275 0.343 0.413	0.125 0.156 0.187 0.25 0.312 0.375	0.015 0.015 0.015 0.02 0.02 0.03	0.25 0.25 0.25 0.312 0.312 0.5	<b>STD125-500-125-J1S</b> <b>STD156-500-156-J1S</b> <b>STD187-500-187-J1S</b> <b>STD250-500-250-J1S</b> <b>STD312-500-312-J1S</b> <b>STD375-500-375-J1S</b>
<b>0.562</b>	–0.001 –0.001 –0.002	0.812 0.936 1.062	+0.002 +0.002 +0.003	0.138 0.206 0.275	0.125 0.187 0.25	0.015 0.015 0.02	0.25 0.25 0.312	<b>STD125-562-125-J1S</b> <b>STD187-562-187-J1S</b> <b>STD250-562-250-J1S</b>

### 3.5 STD profile rod seals, inch sizes d 0.625 – 1.75 in.

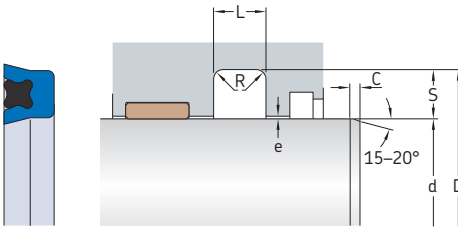

#### Maximum extrusion gap e

Radial depth	$e_{max}$ at 60 °C (140 °F) for pressures		
	2 300 psi	3 600 psi	5 800 psi
S	2 300 psi	3 600 psi	5 800 psi
in.	in.		
<b>0.125</b>	0.008	0.004	–
<b>0.156 to 0.187</b>	0.014	0.008	–
<b>0.218 to 0.25</b>	0.018	0.010	0.004
<b>0.281 to 0.437</b>	0.020	0.012	0.006
<b>0.5 to 0.562</b>	0.024	0.012	0.008
<b>0.625 to 0.75</b>	0.024	0.012	0.008

#### Cylinder dimensions

#### Designation

d	Tolerance	D	Tolerance	L +0.01	S	R max.	C min.	Designation
in.								–
<b>0.625</b>	-0.001	0.875	+0.002	0.138	0.125	0.015	0.25	<b>STD125-625-125-J1S</b>
	-0.001	0.937	+0.002	0.172	0.156	0.015	0.25	<b>STD156-625-156-J1S</b>
	-0.001	0.999	+0.002	0.206	0.187	0.015	0.25	<b>STD187-625-187-J1S</b>
	-0.002	1.125	+0.003	0.275	0.25	0.02	0.312	<b>STD250-625-250-J1S</b>
	-0.002	1.249	+0.003	0.343	0.312	0.02	0.312	<b>STD312-625-312-J1S</b>
	-0.002	1.375	+0.004	0.413	0.375	0.03	0.5	<b>STD375-625-375-J1S</b>
	-0.003	1.625	+0.007	0.550	0.5	0.03	0.625	<b>STD500-625-500-J1S</b>
<b>0.687</b>	-0.001	0.937	+0.002	0.138	0.125	0.015	0.25	<b>STD125-687-125-J1S</b>
<b>0.75</b>	-0.001	1	+0.002	0.138	0.125	0.015	0.25	<b>STD125-750-125-J1S</b>
	-0.001	1.062	+0.002	0.172	0.156	0.015	0.25	<b>STD156-750-156-J1S</b>
	-0.001	1.124	+0.002	0.206	0.187	0.015	0.25	<b>STD187-750-187-J1S</b>
	-0.002	1.25	+0.003	0.275	0.25	0.02	0.312	<b>STD250-750-250-J1S</b>
	-0.002	1.374	+0.003	0.343	0.312	0.02	0.312	<b>STD312-750-312-J1S</b>
	-0.002	1.5	+0.004	0.413	0.375	0.03	0.5	<b>STD375-750-375-J1S</b>
<b>0.812</b>	-0.001	1.062	+0.002	0.138	0.125	0.015	0.25	<b>STD125-812-125-J1S</b>
	-0.002	1.312	+0.003	0.275	0.25	0.02	0.312	<b>STD250-812-250-J1S</b>
<b>0.875</b>	-0.001	1.125	+0.002	0.138	0.125	0.015	0.25	<b>STD125-875-125-J1S</b>
	-0.001	1.249	+0.002	0.206	0.187	0.015	0.25	<b>STD187-875-187-J1S</b>
	-0.002	1.375	+0.003	0.275	0.25	0.02	0.312	<b>STD250-875-250-J1S</b>
	-0.002	1.499	+0.003	0.343	0.312	0.02	0.312	<b>STD312-875-312-J1S</b>
	-0.002	1.625	+0.004	0.413	0.375	0.03	0.5	<b>STD375-875-375-J1S</b>
<b>0.937</b>	-0.002	1.687	+0.004	0.413	0.375	0.03	0.5	<b>STD375-937-375-J1S</b>
<b>1</b>	-0.001	1.25	+0.002	0.138	0.125	0.015	0.25	<b>STD125-1000-125-J1S</b>
	-0.001	1.312	+0.002	0.172	0.156	0.015	0.25	<b>STD156-1000-156-J1S</b>
	-0.001	1.374	+0.002	0.206	0.187	0.015	0.25	<b>STD187-1000-187-J1S</b>
	-0.002	1.5	+0.003	0.275	0.25	0.02	0.312	<b>STD250-1000-250-J1S</b>
	-0.002	1.562	+0.003	0.309	0.281	0.02	0.312	<b>STD281-1000-281-J1S</b>
	-0.002	1.624	+0.003	0.343	0.312	0.02	0.312	<b>STD312-1000-312-J1S</b>
	-0.002	1.75	+0.004	0.413	0.375	0.03	0.5	<b>STD375-1000-375-J1S</b>
	-0.003	2	+0.007	0.550	0.5	0.03	0.625	<b>STD500-1000-500-J1S</b>
<b>1.062</b>	-0.001	1.312	+0.002	0.138	0.125	0.015	0.25	<b>STD125-1062-125-J1S</b>
	-0.001	1.436	+0.002	0.206	0.187	0.015	0.25	<b>STD187-1062-187-J1S</b>



Cylinder dimensions							Designation	
d	Tolerance	D	Tolerance	L +0.01	S	R max.	C min.	
in.								-
<b>1.125</b>	-0.001	1.375	+0.002	0.138	0.125	0.015	0.25	STD125-1125-125-J15
	-0.001	1.437	+0.002	0.172	0.156	0.015	0.25	STD156-1125-156-J15
	-0.001	1.499	+0.002	0.206	0.187	0.015	0.25	STD187-1125-187-J15
	-0.002	1.625	+0.003	0.275	0.25	0.02	0.312	STD250-1125-250-J15
	-0.002	1.749	+0.003	0.343	0.312	0.02	0.312	STD312-1125-312-J15
	-0.002	1.875	+0.004	0.413	0.375	0.03	0.5	STD375-1125-375-J15
<b>1.187</b>	-0.001	1.499	+0.002	0.172	0.156	0.015	0.25	STD156-1187-156-J15
	-0.001	1.561	+0.002	0.206	0.187	0.015	0.25	STD187-1187-187-J15
	-0.002	1.687	+0.003	0.275	0.25	0.02	0.312	STD250-1187-250-J15
	-0.002	1.811	+0.003	0.343	0.312	0.02	0.312	STD312-1187-312-J15
<b>1.25</b>	-0.001	1.5	+0.002	0.138	0.125	0.015	0.25	STD125-1250-125-J15
	-0.001	1.562	+0.002	0.172	0.156	0.015	0.25	STD156-1250-156-J15
	-0.001	1.624	+0.002	0.206	0.187	0.015	0.25	STD187-1250-187-J15
	-0.002	1.75	+0.003	0.275	0.25	0.02	0.312	STD250-1250-250-J15
	-0.002	1.874	+0.003	0.343	0.312	0.02	0.312	STD312-1250-312-J15
	-0.002	2	+0.004	0.413	0.375	0.03	0.5	STD375-1250-375-J15
	-0.003	2.25	+0.007	0.550	0.5	0.03	0.625	STD500-1250-500-J15
	-0.003	2.5	+0.007	0.688	0.625	0.045	0.875	STD625-1250-625-J15
<b>1.312</b>	-0.001	1.562	+0.002	0.138	0.125	0.015	0.25	STD125-1312-125-J15
	-0.001	1.686	+0.002	0.206	0.187	0.015	0.25	STD187-1312-187-J15
	-0.002	1.812	+0.003	0.275	0.25	0.02	0.312	STD250-1312-250-J15
	-0.002	2.062	+0.004	0.413	0.375	0.03	0.5	STD375-1312-375-J15
<b>1.375</b>	-0.001	1.687	+0.002	0.172	0.156	0.015	0.25	STD156-1375-156-J15
	-0.001	1.749	+0.002	0.206	0.187	0.015	0.25	STD187-1375-187-J15
	-0.002	1.875	+0.003	0.275	0.25	0.02	0.312	STD250-1375-250-J15
	-0.002	1.999	+0.003	0.343	0.312	0.02	0.312	STD312-1375-312-J15
	-0.002	2.125	+0.004	0.413	0.375	0.03	0.5	STD375-1375-375-J15
<b>1.437</b>	-0.001	1.687	+0.002	0.138	0.125	0.015	0.25	STD125-1437-125-J15
	-0.001	1.811	+0.002	0.206	0.187	0.015	0.25	STD187-1437-187-J15
	-0.002	1.937	+0.003	0.275	0.25	0.02	0.312	STD250-1437-250-J15
	-0.002	2.061	+0.003	0.343	0.312	0.02	0.312	STD312-1437-312-J15
<b>1.5</b>	-0.001	1.75	+0.002	0.138	0.125	0.015	0.25	STD125-1500-125-J15
	-0.001	1.874	+0.002	0.206	0.187	0.015	0.25	STD187-1500-187-J15
	-0.002	2	+0.003	0.275	0.25	0.02	0.312	STD250-1500-250-J15
	-0.002	2.124	+0.003	0.343	0.312	0.02	0.312	STD312-1500-312-J15
	-0.002	2.25	+0.004	0.413	0.375	0.03	0.5	STD375-1500-375-J15
	-0.002	2.374	+0.004	0.481	0.437	0.03	0.5	STD437-1500-437-J15
-0.003	2.5	+0.007	0.550	0.5	0.03	0.625	STD500-1500-500-J15	
<b>1.562</b>	-0.001	1.812	+0.002	0.138	0.125	0.015	0.25	STD125-1562-125-J15
	-0.001	1.936	+0.002	0.206	0.187	0.015	0.25	STD187-1562-187-J15
	-0.002	2.312	+0.004	0.413	0.375	0.03	0.5	STD375-1562-375-J15
<b>1.593</b>	-0.002	2.093	+0.003	0.275	0.25	0.02	0.312	STD250-1593-250-J15
<b>1.625</b>	-0.001	1.875	+0.002	0.138	0.125	0.015	0.25	STD125-1625-125-J15
	-0.001	1.999	+0.002	0.206	0.187	0.015	0.25	STD187-1625-187-J15
	-0.002	2.125	+0.003	0.275	0.25	0.02	0.312	STD250-1625-250-J15
	-0.002	2.249	+0.003	0.343	0.312	0.02	0.312	STD312-1625-312-J15
	-0.002	2.375	+0.004	0.413	0.375	0.03	0.5	STD375-1625-375-J15
	-0.003	2.625	+0.007	0.550	0.5	0.03	0.625	STD500-1625-500-J15
<b>1.687</b>	-0.001	2.061	+0.002	0.206	0.187	0.015	0.25	STD187-1687-187-J15
	-0.002	2.311	+0.003	0.343	0.312	0.02	0.312	STD312-1687-312-J15
<b>1.75</b>	-0.001	2	+0.002	0.138	0.125	0.015	0.25	STD125-1750-125-J15
	-0.001	2.124	+0.002	0.206	0.187	0.015	0.25	STD187-1750-187-J15
	-0.002	2.25	+0.003	0.275	0.25	0.02	0.312	STD250-1750-250-J15
	-0.002	2.374	+0.003	0.343	0.312	0.02	0.312	STD312-1750-312-J15

3.5

### 3.5 STD profile rod seals, inch sizes d 1.75 – 3.25 in.

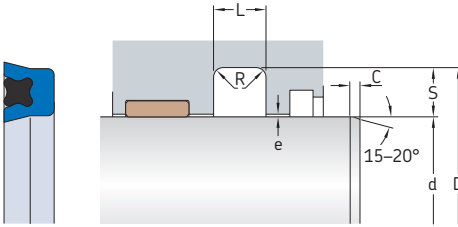

#### Maximum extrusion gap e

Radial depth	$e_{\max}$ at 60 °C (140 °F) for pressures		
	2 300 psi	3 600 psi	5 800 psi
S			
in.	in.		
<b>0.125</b>	0.008	0.004	–
<b>0.156 to 0.187</b>	0.014	0.008	–
<b>0.218 to 0.25</b>	0.018	0.010	0.004
<b>0.281 to 0.437</b>	0.020	0.012	0.006
<b>0.5 to 0.562</b>	0.024	0.012	0.008
<b>0.625 to 0.75</b>	0.024	0.012	0.008

#### Cylinder dimensions

#### Designation

d	Tolerance	D	Tolerance	L	S	R	C	Designation
				+0.01		max.	min.	
in.								–
<b>1.75</b>	-0.002	2.5	+0.004	0.413	0.375	0.03	0.5	<b>STD375-1750-375-J1S</b>
cont.	-0.003	2.75	+0.007	0.550	0.5	0.03	0.625	<b>STD500-1750-500-J1S</b>
	-0.003	3	+0.007	0.688	0.625	0.045	0.875	<b>STD625-1750-625-J1S</b>
<b>1.875</b>	-0.001	2.125	+0.002	0.138	0.125	0.015	0.25	<b>STD125-1875-125-J1S</b>
	-0.001	2.249	+0.002	0.206	0.187	0.015	0.25	<b>STD187-1875-187-J1S</b>
	-0.002	2.375	+0.003	0.275	0.25	0.02	0.312	<b>STD250-1875-250-J1S</b>
	-0.002	2.499	+0.003	0.343	0.312	0.02	0.312	<b>STD312-1875-312-J1S</b>
	-0.002	2.625	+0.004	0.413	0.375	0.03	0.5	<b>STD375-1875-375-J1S</b>
	-0.002	2.749	+0.004	0.481	0.437	0.03	0.5	<b>STD437-1875-437-J1S</b>
<b>1.937</b>	-0.002	2.561	+0.003	0.343	0.312	0.02	0.312	<b>STD312-1937-312-J1S</b>
<b>2</b>	-0.001	2.374	+0.002	0.206	0.187	0.015	0.25	<b>STD187-2000-187-J1S</b>
	-0.002	2.5	+0.003	0.275	0.25	0.02	0.312	<b>STD250-2000-250-J1S</b>
	-0.002	2.624	+0.003	0.343	0.312	0.02	0.312	<b>STD312-2000-312-J1S</b>
	-0.002	2.75	+0.004	0.413	0.375	0.03	0.5	<b>STD375-2000-375-J1S</b>
	-0.003	3	+0.007	0.550	0.5	0.03	0.625	<b>STD500-2000-500-J1S</b>
	-0.003	3.25	+0.007	0.688	0.625	0.045	0.875	<b>STD625-2000-625-J1S</b>
<b>2.125</b>	-0.001	2.375	+0.002	0.138	0.125	0.015	0.25	<b>STD125-2125-125-J1S</b>
	-0.001	2.499	+0.002	0.206	0.187	0.015	0.25	<b>STD187-2125-187-J1S</b>
	-0.002	2.625	+0.003	0.275	0.25	0.02	0.312	<b>STD250-2125-250-J1S</b>
	-0.002	2.749	+0.003	0.343	0.312	0.02	0.312	<b>STD312-2125-312-J1S</b>
	-0.002	2.875	+0.004	0.413	0.375	0.03	0.5	<b>STD375-2125-375-J1S</b>
<b>2.25</b>	-0.001	2.624	+0.002	0.206	0.187	0.015	0.25	<b>STD187-2250-187-J1S</b>
	-0.002	2.75	+0.003	0.275	0.25	0.02	0.312	<b>STD250-2250-250-J1S</b>
	-0.002	2.874	+0.003	0.343	0.312	0.02	0.312	<b>STD312-2250-312-J1S</b>
	-0.002	3	+0.004	0.413	0.375	0.03	0.5	<b>STD375-2250-375-J1S</b>
	-0.003	3.25	+0.007	0.550	0.5	0.03	0.625	<b>STD500-2250-500-J1S</b>
	-0.003	3.5	+0.007	0.688	0.625	0.045	0.875	<b>STD625-2250-625-J1S</b>
<b>2.312</b>	-0.002	2.874	+0.003	0.309	0.281	0.02	0.312	<b>STD281-2312-281-J1S</b>
<b>2.375</b>	-0.001	2.625	+0.002	0.138	0.125	0.015	0.25	<b>STD125-2375-125-J1S</b>
	-0.001	2.749	+0.002	0.206	0.187	0.015	0.25	<b>STD187-2375-187-J1S</b>
	-0.002	2.875	+0.003	0.275	0.25	0.02	0.312	<b>STD250-2375-250-J1S</b>
	-0.002	2.999	+0.003	0.343	0.312	0.02	0.312	<b>STD312-2375-312-J1S</b>
	-0.002	3.125	+0.004	0.413	0.375	0.03	0.5	<b>STD375-2375-375-J1S</b>
	-0.003	3.375	+0.007	0.550	0.5	0.03	0.625	<b>STD500-2375-500-J1S</b>

Cylinder dimensions				Designation				
d	Tolerance	D	Tolerance	L +0.01	S	R max.	C min.	
in.								-
2.437	-0.002	2.937	+0.003	0.275	0.25	0.02	0.312	STD250-2437-250-J15
	-0.002	3.187	+0.004	0.413	0.375	0.03	0.5	STD375-2437-375-J15
2.5	-0.001	2.75	+0.002	0.138	0.125	0.015	0.25	STD125-2500-125-J15
	-0.001	2.874	+0.002	0.206	0.187	0.015	0.25	STD187-2500-187-J15
	-0.002	2.936	+0.003	0.240	0.218	0.015	0.25	STD218-2500-218-J15
	-0.002	3	+0.003	0.275	0.25	0.02	0.312	STD250-2500-250-J15
	-0.002	3.124	+0.003	0.343	0.312	0.02	0.312	STD312-2500-312-J15
	-0.002	3.25	+0.004	0.413	0.375	0.03	0.5	STD375-2500-375-J15
	-0.002	3.374	+0.004	0.481	0.437	0.03	0.5	STD437-2500-437-J15
	-0.003	3.5	+0.007	0.550	0.5	0.03	0.625	STD500-2500-500-J15
	-0.003	3.75	+0.007	0.688	0.625	0.045	0.875	STD625-2500-625-J15
	2.562	-0.002	3.062	+0.003	0.275	0.25	0.02	0.312
-0.002		3.186	+0.003	0.343	0.312	0.02	0.312	STD312-2562-312-J15
-0.002		3.312	+0.004	0.413	0.375	0.03	0.5	STD375-2562-375-J15
2.625	-0.001	2.875	+0.002	0.138	0.125	0.015	0.25	STD125-2625-125-J15
	-0.001	2.999	+0.002	0.206	0.187	0.015	0.25	STD187-2625-187-J15
	-0.002	3.125	+0.003	0.275	0.25	0.02	0.312	STD250-2625-250-J15
	-0.002	3.249	+0.003	0.343	0.312	0.02	0.312	STD312-2625-312-J15
	-0.002	3.375	+0.004	0.413	0.375	0.03	0.5	STD375-2625-375-J15
2.75	-0.001	3.124	+0.002	0.206	0.187	0.015	0.25	STD187-2750-187-J15
	-0.002	3.25	+0.003	0.275	0.25	0.02	0.312	STD250-2750-250-J15
	-0.002	3.374	+0.003	0.343	0.312	0.02	0.312	STD312-2750-312-J15
	-0.002	3.5	+0.004	0.413	0.375	0.03	0.5	STD375-2750-375-J15
	-0.002	3.624	+0.004	0.481	0.437	0.03	0.5	STD437-2750-437-J15
	-0.003	3.75	+0.007	0.550	0.5	0.03	0.625	STD500-2750-500-J15
-0.003	4	+0.007	0.688	0.625	0.045	0.875	STD625-2750-625-J15	
2.812	-0.002	3.562	+0.004	0.413	0.375	0.03	0.5	STD375-2812-375-J15
2.875	-0.001	3.249	+0.002	0.206	0.187	0.015	0.25	STD187-2875-187-J15
	-0.002	3.375	+0.003	0.275	0.25	0.02	0.312	STD250-2875-250-J15
	-0.002	3.499	+0.003	0.343	0.312	0.02	0.312	STD312-2875-312-J15
	-0.002	3.625	+0.004	0.413	0.375	0.03	0.5	STD375-2875-375-J15
2.937	-0.002	3.687	+0.004	0.413	0.375	0.03	0.5	STD375-2937-375-J15
3	-0.001	3.25	+0.002	0.138	0.125	0.015	0.25	STD125-3000-125-J15
	-0.001	3.374	+0.002	0.206	0.187	0.015	0.25	STD187-3000-187-J15
	-0.002	3.436	+0.003	0.240	0.218	0.015	0.25	STD218-3000-218-J15
	-0.002	3.5	+0.003	0.275	0.25	0.02	0.312	STD250-3000-250-J15
	-0.002	3.624	+0.003	0.343	0.312	0.02	0.312	STD312-3000-312-J15
	-0.002	3.75	+0.004	0.413	0.375	0.03	0.5	STD375-3000-375-J15
	-0.003	4	+0.007	0.550	0.5	0.03	0.625	STD500-3000-500-J15
	-0.003	4.25	+0.007	0.688	0.625	0.045	0.875	STD625-3000-625-J15
3.125	-0.001	3.375	+0.002	0.138	0.125	0.015	0.25	STD125-3125-125-J15
	-0.001	3.499	+0.002	0.206	0.187	0.015	0.25	STD187-3125-187-J15
	-0.002	3.625	+0.003	0.275	0.25	0.02	0.312	STD250-3125-250-J15
	-0.002	3.749	+0.003	0.343	0.312	0.02	0.312	STD312-3125-312-J15
	-0.002	3.875	+0.004	0.413	0.375	0.03	0.5	STD375-3125-375-J15
	-0.002	3.999	+0.004	0.481	0.437	0.03	0.5	STD437-3125-437-J15
3.25	-0.001	3.5	+0.002	0.138	0.125	0.015	0.25	STD125-3250-125-J15
	-0.001	3.624	+0.002	0.206	0.187	0.015	0.25	STD187-3250-187-J15
	-0.002	3.75	+0.003	0.275	0.25	0.02	0.312	STD250-3250-250-J15
	-0.002	3.874	+0.003	0.343	0.312	0.02	0.312	STD312-3250-312-J15
	-0.002	4	+0.004	0.413	0.375	0.03	0.5	STD375-3250-375-J15
	-0.002	4.124	+0.004	0.481	0.437	0.03	0.5	STD437-3250-437-J15
	-0.003	4.25	+0.007	0.550	0.5	0.03	0.625	STD500-3250-500-J15
-0.003	4.5	+0.007	0.688	0.625	0.045	0.875	STD625-3250-625-J15	

3.5

### 3.5 STD profile rod seals, inch sizes d 3.375 – 5.125 in.

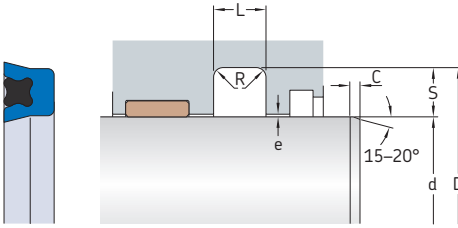

#### Maximum extrusion gap e

Radial depth	$e_{max}$ at 60 °C (140 °F) for pressures		
	2 300 psi	3 600 psi	5 800 psi
S			
in.	in.		
<b>0.125</b>	0.008	0.004	–
<b>0.156 to 0.187</b>	0.014	0.008	–
<b>0.218 to 0.25</b>	0.018	0.010	0.004
<b>0.281 to 0.437</b>	0.020	0.012	0.006
<b>0.5 to 0.562</b>	0.024	0.012	0.008
<b>0.625 to 0.75</b>	0.024	0.012	0.008

#### Cylinder dimensions

#### Designation

d	Tolerance	D	Tolerance	L +0.01	S	R max.	C min.	Designation
in.								–
3.375	-0.001	3.749	+0.002	0.206	0.187	0.015	0.25	STD187-3375-187-J1S
	-0.002	3.875	+0.003	0.275	0.25	0.02	0.312	STD250-3375-250-J1S
	-0.002	4.125	+0.004	0.413	0.375	0.03	0.5	STD375-3375-375-J1S
3.5	-0.001	3.75	+0.002	0.138	0.125	0.015	0.25	STD125-3500-125-J1S
	-0.002	4	+0.003	0.275	0.25	0.02	0.312	STD250-3500-250-J1S
	-0.002	4.124	+0.003	0.343	0.312	0.02	0.312	STD312-3500-312-J1S
	-0.002	4.25	+0.004	0.413	0.375	0.03	0.5	STD375-3500-375-J1S
	-0.003	4.5	+0.007	0.550	0.5	0.03	0.625	STD500-3500-500-J1S
	-0.003	4.75	+0.007	0.688	0.625	0.045	0.875	STD625-3500-625-J1S
-0.003	5	+0.007	0.825	0.75	0.045	1	STD750-3500-750-J1S	
3.625	-0.001	3.999	+0.002	0.206	0.187	0.015	0.25	STD187-3625-187-J1S
	-0.002	4.125	+0.003	0.275	0.25	0.02	0.312	STD250-3625-250-J1S
	-0.002	4.249	+0.003	0.343	0.312	0.02	0.312	STD312-3625-312-J1S
	-0.002	4.375	+0.004	0.413	0.375	0.03	0.5	STD375-3625-375-J1S
3.75	-0.001	4	+0.002	0.138	0.125	0.015	0.25	STD125-3750-125-J1S
	-0.001	4.124	+0.002	0.206	0.187	0.015	0.25	STD187-3750-187-J1S
	-0.002	4.25	+0.003	0.275	0.25	0.02	0.312	STD250-3750-250-J1S
	-0.002	4.374	+0.003	0.343	0.312	0.02	0.312	STD312-3750-312-J1S
	-0.002	4.5	+0.004	0.413	0.375	0.03	0.5	STD375-3750-375-J1S
	-0.003	4.75	+0.007	0.550	0.5	0.03	0.625	STD500-3750-500-J1S
-0.003	5	+0.007	0.688	0.625	0.045	0.875	STD625-3750-625-J1S	
3.875	-0.001	4.249	+0.002	0.206	0.187	0.015	0.25	STD187-3875-187-J1S
	-0.002	4.375	+0.003	0.275	0.25	0.02	0.312	STD250-3875-250-J1S
	-0.002	4.499	+0.003	0.343	0.312	0.02	0.312	STD312-3875-312-J1S
	-0.002	4.625	+0.004	0.413	0.375	0.03	0.5	STD375-3875-375-J1S
4	-0.001	4.25	+0.002	0.138	0.125	0.015	0.25	STD125-4000-125-J1S
	-0.001	4.374	+0.002	0.206	0.187	0.015	0.25	STD187-4000-187-J1S
	-0.002	4.5	+0.003	0.275	0.25	0.02	0.312	STD250-4000-250-J1S
	-0.002	4.624	+0.003	0.343	0.312	0.02	0.312	STD312-4000-312-J1S
	-0.002	4.75	+0.004	0.413	0.375	0.03	0.5	STD375-4000-375-J1S
	-0.002	4.874	+0.004	0.481	0.437	0.03	0.5	STD437-4000-437-J1S
	-0.003	5	+0.007	0.550	0.5	0.03	0.625	STD500-4000-500-J1S
	-0.003	5.25	+0.007	0.688	0.625	0.045	0.875	STD625-4000-625-J1S

Cylinder dimensions								Designation
d	Tolerance	D	Tolerance	L +0.01	S	R max.	C min.	
in.								-
4.125	-0.001	4.499	+0.002	0.206	0.187	0.015	0.25	STD187-4125-187-J15
	-0.002	4.625	+0.003	0.275	0.25	0.02	0.312	STD250-4125-250-J15
	-0.002	4.749	+0.003	0.343	0.312	0.02	0.312	STD312-4125-312-J15
	-0.002	4.875	+0.004	0.413	0.375	0.03	0.5	STD375-4125-375-J15
	-0.002	4.999	+0.004	0.481	0.437	0.03	0.5	STD437-4125-437-J15
4.25	-0.001	4.5	+0.002	0.138	0.125	0.015	0.25	STD125-4250-125-J15
	-0.001	4.624	+0.002	0.206	0.187	0.015	0.25	STD187-4250-187-J15
	-0.002	4.75	+0.003	0.275	0.25	0.02	0.312	STD250-4250-250-J15
	-0.002	4.874	+0.003	0.343	0.312	0.02	0.312	STD312-4250-312-J15
	-0.002	5	+0.004	0.413	0.375	0.03	0.5	STD375-4250-375-J15
4.375	-0.001	4.625	+0.002	0.138	0.125	0.015	0.25	STD125-4375-125-J15
	-0.001	4.749	+0.002	0.206	0.187	0.015	0.25	STD187-4375-187-J15
	-0.002	4.875	+0.003	0.275	0.25	0.02	0.312	STD250-4375-250-J15
	-0.002	4.999	+0.003	0.343	0.312	0.02	0.312	STD312-4375-312-J15
	-0.002	5.125	+0.004	0.413	0.375	0.03	0.5	STD375-4375-375-J15
4.437	-0.002	4.999	+0.003	0.309	0.281	0.02	0.312	STD281-4437-281-J15
4.5	-0.001	4.75	+0.002	0.138	0.125	0.015	0.25	STD125-4500-125-J15
	-0.001	4.874	+0.002	0.206	0.187	0.015	0.25	STD187-4500-187-J15
	-0.002	5	+0.003	0.275	0.25	0.02	0.312	STD250-4500-250-J15
	-0.002	5.124	+0.003	0.343	0.312	0.02	0.312	STD312-4500-312-J15
	-0.002	5.25	+0.004	0.413	0.375	0.03	0.5	STD375-4500-375-J15
4.625	-0.002	5.374	+0.004	0.481	0.437	0.03	0.5	STD437-4500-437-J15
	-0.003	5.5	+0.007	0.550	0.5	0.03	0.625	STD500-4500-500-J15
	-0.003	5.75	+0.007	0.688	0.625	0.045	0.875	STD625-4500-625-J15
	-0.003	6	+0.007	0.825	0.75	0.045	1	STD750-4500-750-J15
	4.75	-0.001	4.999	+0.002	0.206	0.187	0.015	0.25
-0.002		5.125	+0.003	0.275	0.25	0.02	0.312	STD250-4625-250-J15
-0.002		5.375	+0.004	0.413	0.375	0.03	0.5	STD375-4625-375-J15
-0.001		5	+0.002	0.138	0.125	0.015	0.25	STD125-4750-125-J15
-0.001		5.124	+0.002	0.206	0.187	0.015	0.25	STD187-4750-187-J15
4.875	-0.002	5.25	+0.003	0.275	0.25	0.02	0.312	STD250-4750-250-J15
	-0.002	5.374	+0.003	0.343	0.312	0.02	0.312	STD312-4750-312-J15
	-0.002	5.5	+0.004	0.413	0.375	0.03	0.5	STD375-4750-375-J15
	-0.002	5.624	+0.004	0.481	0.437	0.03	0.5	STD437-4750-437-J15
	-0.003	5.75	+0.007	0.550	0.5	0.03	0.625	STD500-4750-500-J15
5	-0.003	6	+0.007	0.688	0.625	0.045	0.875	STD625-4750-625-J15
	-0.001	5.249	+0.002	0.206	0.187	0.015	0.25	STD187-4875-187-J15
	-0.002	5.375	+0.003	0.275	0.25	0.02	0.312	STD250-4875-250-J15
	-0.002	5.499	+0.003	0.343	0.312	0.02	0.312	STD312-4875-312-J15
	-0.002	5.625	+0.004	0.413	0.375	0.03	0.5	STD375-4875-375-J15
5.125	-0.001	5.374	+0.002	0.206	0.187	0.015	0.25	STD187-5000-187-J15
	-0.002	5.5	+0.003	0.275	0.25	0.02	0.312	STD250-5000-250-J15
	-0.002	5.562	+0.003	0.309	0.281	0.02	0.312	STD281-5000-281-J15
	-0.002	5.624	+0.003	0.343	0.312	0.02	0.312	STD312-5000-312-J15
	-0.002	5.75	+0.004	0.413	0.375	0.03	0.5	STD375-5000-375-J15
5.25	-0.003	6	+0.007	0.550	0.5	0.03	0.625	STD500-5000-500-J15
	-0.003	6.25	+0.007	0.688	0.625	0.045	0.875	STD625-5000-625-J15
	-0.003	6.5	+0.007	0.825	0.75	0.045	1	STD750-5000-750-J15
	-0.002	5.625	+0.003	0.275	0.25	0.02	0.312	STD250-5125-250-J15
	-0.002	5.749	+0.003	0.343	0.312	0.02	0.312	STD312-5125-312-J15
5.375	-0.002	5.875	+0.004	0.413	0.375	0.03	0.5	STD375-5125-375-J15
	-0.002	5.999	+0.004	0.481	0.437	0.03	0.5	STD437-5125-437-J15

3.5

### 3.5 STD profile rod seals, inch sizes d 5.25 – 8.125 in.

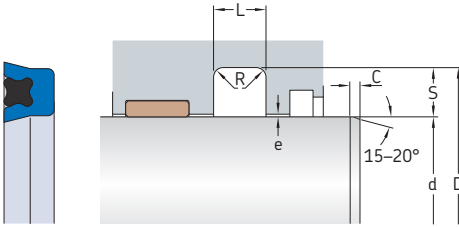

#### Maximum extrusion gap e

Radial depth	$e_{max}$ at 60 °C (140 °F) for pressures		
	2 300 psi	3 600 psi	5 800 psi
S			
in.	in.		
<b>0.125</b>	0.008	0.004	–
<b>0.156 to 0.187</b>	0.014	0.008	–
<b>0.218 to 0.25</b>	0.018	0.010	0.004
<b>0.281 to 0.437</b>	0.020	0.012	0.006
<b>0.5 to 0.562</b>	0.024	0.012	0.008
<b>0.625 to 0.75</b>	0.024	0.012	0.008

#### Cylinder dimensions

#### Designation

d	Tolerance	D	Tolerance	L +0.01	S	R max.	C min.	
in.								–
5.25	-0.002	5.75	+0.003	0.275	0.25	0.02	0.312	STD250-5250-250-J15
	-0.002	5.874	+0.003	0.343	0.312	0.02	0.312	STD312-5250-312-J15
	-0.002	6	+0.004	0.413	0.375	0.03	0.5	STD375-5250-375-J15
	-0.002	6.124	+0.004	0.481	0.437	0.03	0.5	STD437-5250-437-J15
	-0.003	6.25	+0.007	0.550	0.5	0.03	0.625	STD500-5250-500-J15
	-0.003	6.5	+0.007	0.688	0.625	0.045	0.875	STD625-5250-625-J15
5.375	-0.002	5.875	+0.003	0.275	0.25	0.02	0.312	STD250-5375-250-J15
	-0.002	5.999	+0.003	0.343	0.312	0.02	0.312	STD312-5375-312-J15
	-0.002	6.125	+0.004	0.413	0.375	0.03	0.5	STD375-5375-375-J15
5.437	-0.002	5.999	+0.003	0.309	0.281	0.02	0.312	STD281-5437-281-J15
	-0.003	6.437	+0.007	0.550	0.5	0.03	0.625	STD500-5437-500-J15
5.5	-0.001	5.874	+0.002	0.206	0.187	0.015	0.25	STD187-5500-187-J15
	-0.002	6	+0.003	0.275	0.25	0.02	0.312	STD250-5500-250-J15
	-0.002	6.124	+0.003	0.343	0.312	0.02	0.312	STD312-5500-312-J15
	-0.002	6.25	+0.004	0.413	0.375	0.03	0.5	STD375-5500-375-J15
	-0.003	6.5	+0.007	0.550	0.5	0.03	0.625	STD500-5500-500-J15
	-0.003	6.624	+0.007	0.618	0.562	0.03	0.75	STD562-5500-562-J15
	-0.003	6.75	+0.007	0.688	0.625	0.045	0.875	STD625-5500-625-J15
	-0.003	7	+0.007	0.825	0.75	0.045	1	STD750-5500-750-J15
5.625	-0.002	6.125	+0.003	0.275	0.25	0.02	0.312	STD250-5625-250-J15
	-0.002	6.249	+0.003	0.343	0.312	0.02	0.312	STD312-5625-312-J15
	-0.002	6.375	+0.004	0.413	0.375	0.03	0.5	STD375-5625-375-J15
5.75	-0.001	6	+0.002	0.138	0.125	0.015	0.25	STD125-5750-125-J15
	-0.002	6.25	+0.003	0.275	0.25	0.02	0.312	STD250-5750-250-J15
	-0.002	6.5	+0.004	0.413	0.375	0.03	0.5	STD375-5750-375-J15
	-0.003	6.75	+0.007	0.550	0.5	0.03	0.625	STD500-5750-500-J15
	-0.003	7	+0.007	0.688	0.625	0.045	0.875	STD625-5750-625-J15
5.875	-0.002	6.375	+0.003	0.275	0.25	0.02	0.312	STD250-5875-250-J15
	-0.002	6.499	+0.003	0.343	0.312	0.02	0.312	STD312-5875-312-J15
	-0.002	6.625	+0.004	0.413	0.375	0.03	0.5	STD375-5875-375-J15
6	-0.001	6.374	+0.002	0.206	0.187	0.015	0.25	STD187-6000-187-J15
	-0.002	6.5	+0.003	0.275	0.25	0.02	0.312	STD250-6000-250-J15
	-0.002	6.624	+0.003	0.343	0.312	0.02	0.312	STD312-6000-312-J15
	-0.002	6.75	+0.004	0.413	0.375	0.03	0.5	STD375-6000-375-J15

Cylinder dimensions								Designation
d	Tolerance	D	Tolerance	L +0.01	S	R max.	C min.	
in.								-
6	-0.003	7	+0.007	0.550	0.5	0.03	0.625	STD500-6000-500-J15
	-0.003	7.25	+0.007	0.688	0.625	0.045	0.875	STD625-6000-625-J15
	-0.003	7.5	+0.007	0.825	0.75	0.045	1	STD750-6000-750-J15
6.125	-0.002	6.749	+0.003	0.343	0.312	0.02	0.312	STD312-6125-312-J15
	-0.003	7.125	+0.007	0.550	0.5	0.03	0.625	STD500-6125-500-J15
6.25	-0.002	6.75	+0.003	0.275	0.25	0.02	0.312	STD250-6250-250-J15
	-0.002	6.874	+0.003	0.343	0.312	0.02	0.312	STD312-6250-312-J15
	-0.002	7	+0.004	0.413	0.375	0.03	0.5	STD375-6250-375-J15
	-0.003	7.25	+0.007	0.550	0.5	0.03	0.625	STD500-6250-500-J15
	-0.003	7.5	+0.007	0.688	0.625	0.045	0.875	STD625-6250-625-J15
6.375	-0.002	6.999	+0.003	0.343	0.312	0.02	0.312	STD312-6375-312-J15
	-0.002	7.125	+0.004	0.413	0.375	0.03	0.5	STD375-6375-375-J15
6.5	-0.002	7	+0.003	0.275	0.25	0.02	0.312	STD250-6500-250-J15
	-0.002	7.124	+0.003	0.343	0.312	0.02	0.312	STD312-6500-312-J15
	-0.002	7.25	+0.004	0.413	0.375	0.03	0.5	STD375-6500-375-J15
	-0.003	7.5	+0.007	0.550	0.5	0.03	0.625	STD500-6500-500-J15
	-0.003	8	+0.007	0.825	0.75	0.045	1	STD750-6500-750-J15
6.625	-0.002	7.249	+0.003	0.343	0.312	0.02	0.312	STD312-6625-312-J15
6.75	-0.002	7.25	+0.003	0.275	0.25	0.02	0.312	STD250-6750-250-J15
	-0.002	7.374	+0.003	0.343	0.312	0.02	0.312	STD312-6750-312-J15
	-0.002	7.5	+0.004	0.413	0.375	0.03	0.5	STD375-6750-375-J15
	-0.003	7.75	+0.007	0.550	0.5	0.03	0.625	STD500-6750-500-J15
	-0.003	8	+0.007	0.688	0.625	0.045	0.875	STD625-6750-625-J15
7	-0.002	7.5	+0.003	0.275	0.25	0.02	0.312	STD250-7000-250-J15
	-0.002	7.75	+0.004	0.413	0.375	0.03	0.5	STD375-7000-375-J15
	-0.003	8	+0.007	0.550	0.5	0.03	0.625	STD500-7000-500-J15
	-0.003	8.25	+0.007	0.688	0.625	0.045	0.875	STD625-7000-625-J15
	-0.003	8.5	+0.007	0.825	0.75	0.045	1	STD750-7000-750-J15
7.125	-0.003	8.125	+0.007	0.550	0.5	0.03	0.625	STD500-7125-500-J15
7.25	-0.002	7.75	+0.003	0.275	0.25	0.02	0.312	STD250-7250-250-J15
	-0.002	7.874	+0.003	0.343	0.312	0.02	0.312	STD312-7250-312-J15
	-0.002	8	+0.004	0.413	0.375	0.03	0.5	STD375-7250-375-J15
	-0.003	8.25	+0.007	0.550	0.5	0.03	0.625	STD500-7250-500-J15
	-0.003	8.5	+0.007	0.688	0.625	0.045	0.875	STD625-7250-625-J15
7.375	-0.002	7.999	+0.003	0.343	0.312	0.02	0.312	STD312-7375-312-J15
7.5	-0.002	8	+0.003	0.275	0.25	0.02	0.312	STD250-7500-250-J15
	-0.002	8.124	+0.003	0.343	0.312	0.02	0.312	STD312-7500-312-J15
	-0.002	8.25	+0.004	0.413	0.375	0.03	0.5	STD375-7500-375-J15
	-0.003	8.5	+0.007	0.550	0.5	0.03	0.625	STD500-7500-500-J15
	-0.003	9	+0.007	0.825	0.75	0.045	1	STD750-7500-750-J15
7.625	-0.002	8.375	+0.004	0.413	0.375	0.03	0.5	STD375-7625-375-J15
7.75	-0.002	8.25	+0.003	0.275	0.25	0.02	0.312	STD250-7750-250-J15
	-0.002	8.5	+0.004	0.413	0.375	0.03	0.5	STD375-7750-375-J15
	-0.003	8.75	+0.007	0.550	0.5	0.03	0.625	STD500-7750-500-J15
	-0.003	9	+0.007	0.688	0.625	0.045	0.875	STD625-7750-625-J15
8	-0.002	8.5	+0.003	0.275	0.25	0.02	0.312	STD250-8000-250-J15
	-0.002	8.75	+0.004	0.413	0.375	0.03	0.5	STD375-8000-375-J15
	-0.003	9	+0.007	0.550	0.5	0.03	0.625	STD500-8000-500-J15
	-0.003	9.25	+0.007	0.688	0.625	0.045	0.875	STD625-8000-625-J15
	-0.003	9.5	+0.007	0.825	0.75	0.045	1	STD750-8000-750-J15
8.125	-0.002	8.625	+0.003	0.275	0.25	0.02	0.312	STD250-8125-250-J15

3.5

### 3.5 STD profile rod seals, inch sizes d 8.25 – 13.75 in.

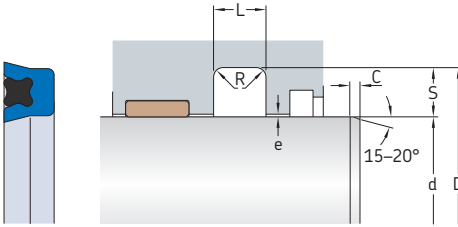

#### Maximum extrusion gap e

Radial depth	$e_{\max}$ at 60 °C (140 °F) for pressures		
	2 300 psi	3 600 psi	5 800 psi
S			
in.	in.		
<b>0.125</b>	0.008	0.004	–
<b>0.156 to 0.187</b>	0.014	0.008	–
<b>0.218 to 0.25</b>	0.018	0.010	0.004
<b>0.281 to 0.437</b>	0.020	0.012	0.006
<b>0.5 to 0.562</b>	0.024	0.012	0.008
<b>0.625 to 0.75</b>	0.024	0.012	0.008

#### Cylinder dimensions

#### Designation

d	Tolerance	D	Tolerance	L +0.01	S	R max.	C min.	
in.								–
8.25	-0.002	8.75	+0.003	0.275	0.25	0.02	0.312	STD250-8250-250-J15
	-0.002	9	+0.004	0.413	0.375	0.03	0.5	STD375-8250-375-J15
	-0.003	9.25	+0.007	0.550	0.5	0.03	0.625	STD500-8250-500-J15
8.5	-0.002	9	+0.003	0.275	0.25	0.02	0.312	STD250-8500-250-J15
	-0.002	9.25	+0.004	0.413	0.375	0.03	0.5	STD375-8500-375-J15
	-0.003	9.5	+0.007	0.550	0.5	0.03	0.625	STD500-8500-500-J15
	-0.003	9.75	+0.007	0.688	0.625	0.045	0.875	STD625-8500-625-J15
-0.003	10	+0.007	0.825	0.75	0.045	1	STD750-8500-750-J15	
8.625	-0.002	9.375	+0.004	0.413	0.375	0.03	0.5	STD375-8625-375-J15
8.75	-0.002	9.25	+0.003	0.275	0.25	0.02	0.312	STD250-8750-250-J15
	-0.002	9.5	+0.004	0.413	0.375	0.03	0.5	STD375-8750-375-J15
	-0.003	9.75	+0.007	0.550	0.5	0.03	0.625	STD500-8750-500-J15
	-0.003	10	+0.007	0.688	0.625	0.045	0.875	STD625-8750-625-J15
8.875	-0.002	9.499	+0.003	0.343	0.312	0.02	0.312	STD312-8875-312-J15
9	-0.002	9.5	+0.003	0.275	0.25	0.02	0.312	STD250-9000-250-J15
	-0.002	9.75	+0.004	0.413	0.375	0.03	0.5	STD375-9000-375-J15
	-0.003	10	+0.007	0.550	0.5	0.03	0.625	STD500-9000-500-J15
	-0.003	10.25	+0.007	0.688	0.625	0.045	0.875	STD625-9000-625-J15
-0.003	10.5	+0.007	0.825	0.75	0.045	1	STD750-9000-750-J15	
9.25	-0.002	9.75	+0.003	0.275	0.25	0.02	0.312	STD250-9250-250-J15
	-0.003	10.5	+0.007	0.688	0.625	0.045	0.875	STD625-9250-625-J15
9.312	-0.002	9.998	+0.003	0.377	0.343	0.02	0.312	STD343-9312-343-J15
9.5	-0.002	10	+0.003	0.275	0.25	0.02	0.312	STD250-9500-250-J15
	-0.002	10.25	+0.004	0.413	0.375	0.03	0.5	STD375-9500-375-J15
	-0.003	10.5	+0.007	0.550	0.5	0.03	0.625	STD500-9500-500-J15
	-0.003	10.75	+0.007	0.688	0.625	0.045	0.875	STD625-9500-625-J15
-0.003	11	+0.007	0.825	0.75	0.045	1	STD750-9500-750-J15	
9.75	-0.002	10.25	+0.003	0.275	0.25	0.02	0.312	STD250-9750-250-J15
	-0.002	10.5	+0.004	0.413	0.375	0.03	0.5	STD375-9750-375-J15
	-0.003	10.75	+0.007	0.550	0.5	0.03	0.625	STD500-9750-500-J15
	-0.003	11	+0.007	0.688	0.625	0.045	0.875	STD625-9750-625-J15



Cylinder dimensions				Designation				
d	Tolerance	D	Tolerance	L +0.01	S	R max.	C min.	
in.								-
9.875	-0.002	10.625	+0.004	0.413	0.375	0.03	0.5	STD375-9875-375-J1S
10	-0.002	10.5	+0.003	0.275	0.25	0.02	0.312	STD250-10000-250-J1S
	-0.002	10.75	+0.004	0.413	0.375	0.03	0.5	STD375-10000-375-J1S
	-0.003	11	+0.007	0.550	0.5	0.03	0.625	STD500-10000-500-J1S
	-0.003	11.25	+0.007	0.688	0.625	0.045	0.875	STD625-10000-625-J1S
	-0.003	11.5	+0.007	0.825	0.75	0.045	1	STD750-10000-750-J1S
10.25	-0.002	10.75	+0.003	0.275	0.25	0.02	0.312	STD250-10250-250-J1S
	-0.002	11	+0.004	0.413	0.375	0.03	0.5	STD375-10250-375-J1S
	-0.003	11.5	+0.007	0.688	0.625	0.045	0.875	STD625-10250-625-J1S
10.5	-0.002	11	+0.003	0.275	0.25	0.02	0.312	STD250-10500-250-J1S
	-0.002	11.25	+0.004	0.413	0.375	0.03	0.5	STD375-10500-375-J1S
	-0.003	11.5	+0.007	0.550	0.5	0.03	0.625	STD500-10500-500-J1S
	-0.003	12	+0.007	0.825	0.75	0.045	1	STD750-10500-750-J1S
10.75	-0.002	11.25	+0.003	0.275	0.25	0.02	0.312	STD250-10750-250-J1S
	-0.002	11.5	+0.004	0.413	0.375	0.03	0.5	STD375-10750-375-J1S
	-0.003	11.75	+0.007	0.550	0.5	0.03	0.625	STD500-10750-500-J1S
	-0.003	12	+0.007	0.688	0.625	0.045	0.875	STD625-10750-625-J1S
11	-0.002	11.75	+0.004	0.413	0.375	0.03	0.5	STD375-11000-375-J1S
	-0.003	12	+0.007	0.550	0.5	0.03	0.625	STD500-11000-500-J1S
	-0.003	12.25	+0.007	0.688	0.625	0.045	0.875	STD625-11000-625-J1S
	-0.003	12.5	+0.007	0.825	0.75	0.045	1	STD750-11000-750-J1S
11.25	-0.002	11.75	+0.003	0.275	0.25	0.02	0.312	STD250-11250-250-J1S
	-0.002	12	+0.004	0.413	0.375	0.03	0.5	STD375-11250-375-J1S
	-0.003	12.25	+0.007	0.550	0.5	0.03	0.625	STD500-11250-500-J1S
11.5	-0.002	12	+0.003	0.275	0.25	0.02	0.312	STD250-11500-250-J1S
	-0.003	12.5	+0.007	0.550	0.5	0.03	0.625	STD500-11500-500-J1S
11.75	-0.002	12.25	+0.003	0.275	0.25	0.02	0.312	STD250-11750-250-J1S
	-0.002	12.5	+0.004	0.413	0.375	0.03	0.5	STD375-11750-375-J1S
	-0.003	13	+0.007	0.688	0.625	0.045	0.875	STD625-11750-625-J1S
12	-0.002	12.5	+0.003	0.275	0.25	0.02	0.312	STD250-12000-250-J1S
	-0.002	12.75	+0.004	0.413	0.375	0.03	0.5	STD375-12000-375-J1S
	-0.003	13	+0.007	0.550	0.5	0.03	0.625	STD500-12000-500-J1S
	-0.003	13.25	+0.007	0.688	0.625	0.045	0.875	STD625-12000-625-J1S
12.25	-0.002	13	+0.004	0.413	0.375	0.03	0.5	STD375-12250-375-J1S
12.5	-0.002	13	+0.003	0.275	0.25	0.02	0.312	STD250-12500-250-J1S
	-0.003	13.5	+0.007	0.550	0.5	0.03	0.625	STD500-12500-500-J1S
	-0.003	14	+0.007	0.825	0.75	0.045	1	STD750-12500-750-J1S
12.75	-0.002	13.5	+0.004	0.413	0.375	0.03	0.5	STD375-12750-375-J1S
	-0.003	14	+0.007	0.688	0.625	0.045	0.875	STD625-12750-625-J1S
13	-0.002	13.75	+0.004	0.413	0.375	0.03	0.5	STD375-13000-375-J1S
	-0.003	14	+0.007	0.550	0.5	0.03	0.625	STD500-13000-500-J1S
	-0.003	14.25	+0.007	0.688	0.625	0.045	0.875	STD625-13000-625-J1S
	-0.003	14.5	+0.007	0.825	0.75	0.045	1	STD750-13000-750-J1S
13.25	-0.002	14	+0.004	0.413	0.375	0.03	0.5	STD375-13250-375-J1S
	-0.003	14.25	+0.007	0.550	0.5	0.03	0.625	STD500-13250-500-J1S
13.375	-0.002	14.125	+0.004	0.413	0.375	0.03	0.5	STD375-13375-375-J1S
13.5	-0.002	14	+0.003	0.275	0.25	0.02	0.312	STD250-13500-250-J1S
	-0.003	14.5	+0.007	0.550	0.5	0.03	0.625	STD500-13500-500-J1S
	-0.003	15	+0.007	0.825	0.75	0.045	1	STD750-13500-750-J1S
13.75	-0.002	14.5	+0.004	0.413	0.375	0.03	0.5	STD375-13750-375-J1S

3.5

### 3.5 STD profile rod seals, inch sizes d 14 – 45 in.

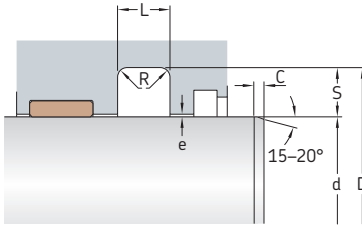
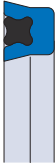

#### Maximum extrusion gap e

Radial depth	$e_{max}$ at 60 °C (140 °F) for pressures		
	2 300 psi	3 600 psi	5 800 psi
S			
in.	in.		
<b>0.125</b>	0.008	0.004	–
<b>0.156 to 0.187</b>	0.014	0.008	–
<b>0.218 to 0.25</b>	0.018	0.010	0.004
<b>0.281 to 0.437</b>	0.020	0.012	0.006
<b>0.5 to 0.562</b>	0.024	0.012	0.008
<b>0.625 to 0.75</b>	0.024	0.012	0.008

#### Cylinder dimensions

#### Designation

d	Tolerance	D	Tolerance	L +0.01	S	R max.	C min.	Designation
in.								–
14	-0.002 -0.003 -0.003	14.75 15 15.5	+0.004 +0.007 +0.007	0.413 0.550 0.825	0.375 0.5 0.75	0.03 0.03 0.045	0.5 0.625 1	STD375-14000-375-J1S STD500-14000-500-J1S STD750-14000-750-J1S
14.25	-0.002	14.75	+0.003	0.275	0.25	0.02	0.312	STD250-14250-250-J1S
14.375	-0.002	14.999	+0.003	0.343	0.312	0.02	0.312	STD312-14375-312-J1S
14.5	-0.003	16	+0.007	0.825	0.75	0.045	1	STD750-14500-750-J1S
15	-0.002 -0.003	15.75 16	+0.004 +0.007	0.413 0.550	0.375 0.5	0.03 0.03	0.5 0.625	STD375-15000-375-J1S STD500-15000-500-J1S
15.5	-0.002 -0.003	16.25 16.5	+0.004 +0.007	0.413 0.550	0.375 0.5	0.03 0.03	0.5 0.625	STD375-15500-375-J1S STD500-15500-500-J1S
16	-0.003 -0.003	17 17.5	+0.007 +0.007	0.550 0.825	0.5 0.75	0.03 0.045	0.625 1	STD500-16000-500-J1S STD750-16000-750-J1S
16.5	-0.003 -0.003	17.5 18	+0.007 +0.007	0.550 0.825	0.5 0.75	0.03 0.045	0.625 1	STD500-16500-500-J1S STD750-16500-750-J1S
16.75	-0.002	17.25	+0.003	0.275	0.25	0.02	0.312	STD250-16750-250-J1S
16.875	-0.002	17.625	+0.004	0.413	0.375	0.03	0.5	STD375-16875-375-J1S
17	-0.003	18	+0.007	0.550	0.5	0.03	0.625	STD500-17000-500-J1S
17.25	-0.002 -0.003	18 18.5	+0.004 +0.007	0.413 0.688	0.375 0.625	0.03 0.045	0.5 0.875	STD375-17250-375-J1S STD625-17250-625-J1S
18	-0.003 -0.003	19 19.5	+0.007 +0.007	0.550 0.825	0.5 0.75	0.03 0.045	0.625 1	STD500-18000-500-J1S STD750-18000-750-J1S
18.375	-0.002	18.875	+0.003	0.275	0.25	0.02	0.312	STD250-18375-250-J1S
19.5	-0.002	20.25	+0.004	0.413	0.375	0.03	0.5	STD375-19500-375-J1S
20	-0.003	21	+0.007	0.550	0.5	0.03	0.625	STD500-20000-500-J1S
20.5	-0.003	22	+0.007	0.825	0.75	0.045	1	STD750-20500-750-J1S

Cylinder dimensions								Designation
d	Tolerance	D	Tolerance	L +0.01	S	R max.	C min.	
in.								-
20.75	-0.002	21.25	+0.003	0.275	0.25	0.02	0.312	STD250-20750-250-J1S
21	-0.003	22	+0.007	0.550	0.5	0.03	0.625	STD500-21000-500-J1S
22	-0.003	23	+0.007	0.550	0.5	0.03	0.625	STD500-22000-500-J1S
23	-0.002	23.5	+0.003	0.275	0.25	0.02	0.312	STD250-23000-250-J1S
23.5	-0.003	24.5	+0.007	0.550	0.5	0.03	0.625	STD500-23500-500-J1S
24	-0.003	25.25	+0.007	0.688	0.625	0.045	0.875	STD625-24000-625-J1S
24.75	-0.003	26	+0.007	0.688	0.625	0.045	0.875	STD625-24750-625-J1S
25	-0.003	26	+0.007	0.550	0.5	0.03	0.625	STD500-25000-500-J1S
26.5	-0.003	27.5	+0.007	0.550	0.5	0.03	0.625	STD500-26500-500-J1S
27	-0.003	28	+0.007	0.550	0.5	0.03	0.625	STD500-27000-500-J1S
27.5	-0.003	28.5	+0.007	0.550	0.5	0.03	0.625	STD500-27500-500-J1S
28.5	-0.003	29.5	+0.007	0.550	0.5	0.03	0.625	STD500-28500-500-J1S
31	-0.003	32	+0.007	0.550	0.5	0.03	0.625	STD500-31000-500-J1S
32	-0.003	33	+0.007	0.550	0.5	0.03	0.625	STD500-32000-500-J1S
34.25	-0.003	35.75	+0.007	0.825	0.75	0.045	1	STD750-34250-750-J1S
35.75	-0.003	36.75	+0.007	0.550	0.5	0.03	0.625	STD500-35750-500-J1S
36	-0.003	37	+0.007	0.550	0.5	0.03	0.625	STD500-36000-500-J1S
	-0.003	37.5	+0.007	0.825	0.75	0.045	1	STD750-36000-750-J1S
36.75	-0.003	37.75	+0.007	0.550	0.5	0.03	0.625	STD500-36750-500-J1S
37	-0.003	38	+0.007	0.550	0.5	0.03	0.625	STD500-37000-500-J1S
38	-0.003	39	+0.007	0.55	0.5	0.03	0.625	STD500-38000-500-J1S
39	-0.003	40	+0.007	0.55	0.5	0.03	0.625	STD500-39000-500-J1S
40	-0.003	41	+0.007	0.55	0.5	0.03	0.625	STD500-40000-500-J1S
40.25	-0.003	41.25	+0.007	0.55	0.5	0.03	0.625	STD500-40250-500-J1S
41	-0.003	42	+0.007	0.55	0.5	0.03	0.625	STD500-41000-500-J1S
42	-0.003	43	+0.007	0.55	0.5	0.03	0.625	STD500-42000-500-J1S
42.75	-0.003	43.75	+0.007	0.55	0.5	0.03	0.625	STD500-42750-500-J1S
43	-0.003	44	+0.007	0.550	0.5	0.03	0.625	STD500-43000-500-J1S
44.5	-0.003	45.5	+0.007	0.55	0.5	0.03	0.625	STD500-44500-500-J1S
45	-0.003	46	+0.007	0.55	0.5	0.03	0.625	STD500-45000-500-J1S

Other sizes are available on request

## DZ profile data



<b>Materials</b>	Primary sealing lip: LT NBR 70A, A-8504 Secondary sealing lip: TPU 95A, U-1003 For additional information → <b>page 26</b>												
<b>Pressure</b>	Up to 400 bar (5 800 psi)												
<b>Speed</b>	Up to 1 m/s (3.2 ft/s)												
<b>Temperature range</b>	<div style="display: flex; align-items: center;"> <table style="margin-left: 10px; border-collapse: collapse;"> <tr> <td style="padding: 0 10px;">-60</td> <td style="padding: 0 10px;">-50</td> <td style="padding: 0 10px;"></td> <td style="padding: 0 10px;">100</td> <td style="padding: 0 10px;">110</td> <td style="padding: 0 10px;">120 [°C]</td> </tr> <tr> <td style="padding: 0 10px;">-75</td> <td style="padding: 0 10px;">-60</td> <td style="padding: 0 10px;"></td> <td style="padding: 0 10px;">210</td> <td style="padding: 0 10px;">230</td> <td style="padding: 0 10px;">250 [°F]</td> </tr> </table> </div> <ul style="list-style-type: none"> <li style="margin-bottom: 10px;"> <span style="display: inline-block; width: 15px; height: 15px; background-color: #0070C0; margin-right: 5px;"></span>                     Extreme low temperature range: seal performance depends on system design (precision guiding arrangement recommended)                 </li> <li style="margin-bottom: 10px;"> <span style="display: inline-block; width: 15px; height: 15px; background-color: #00A651; margin-right: 5px;"></span> <b>Recommended operating temperature range for this profile and material</b> </li> <li style="margin-bottom: 10px;"> <span style="display: inline-block; width: 15px; height: 15px; background-color: #FFD700; margin-right: 5px;"></span>                     Temperatures above the recommended operating range: acceptable only with reduced pressure, speed, and/or e-gap                 </li> <li> <span style="display: inline-block; width: 15px; height: 15px; background-color: #D9534F; margin-right: 5px;"></span>                     Extreme high temperature range: only occasional short term exposure (e.g. cylinder in curing oven of a powder coating process)                 </li> </ul>	-60	-50		100	110	120 [°C]	-75	-60		210	230	250 [°F]
-60	-50		100	110	120 [°C]								
-75	-60		210	230	250 [°F]								
<b>Counter-surface</b>	→ <b>page 22</b>												

Maximum values of application parameters (e.g. pressure, speed, temperature, e-gap) should not be applied continuously nor simultaneously.

### 3.6 DZ profile rod seals, metric sizes d 25 – 105 mm

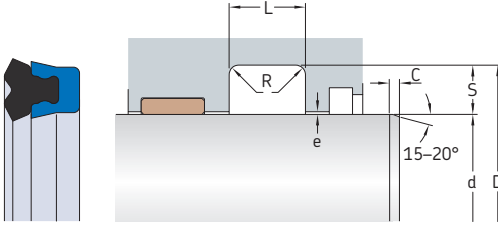

#### Maximum extrusion gap e

Radial depth	$e_{max}$ at 60 °C (140 °F) for pressures		
	160 bar	250 bar	400 bar
5			
mm	mm		
4	0,35	0,2	–
5	0,45	0,25	0,1
7,5	0,5	0,3	0,15

3.6

#### Cylinder dimensions

#### Designation

d	D	L	S	R	C	Designation
h9	H9	+0,2		max.	min.	
mm						–
25	33	7,2	4	0,2	6	DZ-25x33x7.2-E2F
	33	7,6	4	0,2	6	DZ-25x33x7.6-E2F
30	40	9,9	5	0,2	6	DZ-30x40x9.9-E2F
35	45	9,9	5	0,2	6	DZ-35x45x9.9-E2F
40	50	8	5	0,2	6	DZ-40x50x8-E2F
	50	9,9	5	0,2	6	DZ-40x50x9.9-E2F
45	55	9,9	5	0,2	6	DZ-45x55x9.9-E2F
50	60	9,9	5	0,2	6	DZ-50x60x9.9-E2F
55	65	9,9	5	0,2	6	DZ-55x65x9.9-E2F
60	70	9,9	5	0,2	6	DZ-60x70x9.9-E2F
65	75	9,9	5	0,2	6	DZ-65x75x9.9-E2F
70	80	9,9	5	0,2	6	DZ-70x80x9.9-E2F
75	85	9,9	5	0,2	6	DZ-75x85x9.9-E2F
80	90	9,9	5	0,2	6	DZ-80x90x9.9-E2F
85	100	13,8	7,5	0,5	8,5	DZ-85x100x13.8-E2F
90	105	13,2	7,5	0,5	8,5	DZ-90x105x13.2-E2F
100	115	13,2	7,5	0,5	8,5	DZ-100x115x13.2-E2F
105	120	13,2	7,5	0,5	8,5	DZ-105x120x13.2-E2F

Other sizes are available on request

### 3.6 DZ profile rod seals, inch sizes d 0.187 – 3.25 in.

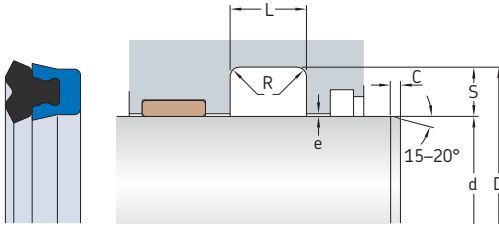

#### Maximum extrusion gap e

Radial depth S	$e_{max}$ at 60 °C (140 °F) for pressures		
	2 300 psi	3 600 psi	5 800 psi
in.	in.		
<b>0.125</b>	0.008	0.004	–
<b>0.156 to 0.187</b>	0.014	0.008	–
<b>0.25</b>	0.018	0.01	0.004
<b>0.312 to 0.375</b>	0.02	0.012	0.006
<b>0.5</b>	0.024	0.012	0.008

#### Cylinder dimensions

#### Designation

d	Tolerance	D	Tolerance	L +0.01	S	R max.	C min.	Designation
in.								–
<b>0.187</b>	-0.001 -0.001	0.437 0.437	+0.002 +0.002	0.213 0.275	0.125 0.125	0.015 0.015	0.25 0.25	<b>DZ125-187-187-E2F</b> <b>DZ125-187-250-E2F</b>
<b>0.375</b>	-0.002	0.875	+0.003	0.413	0.25	0.02	0.312	<b>DZ250-375-375-E2F</b>
<b>0.5</b>	-0.001 -0.002	0.75 0.875	+0.002 +0.002	0.275 0.343	0.125 0.187	0.015 0.015	0.25 0.25	<b>DZ125-500-250-E2F</b> <b>DZ187-500-312-E2F</b>
<b>0.625</b>	-0.001	0.937	+0.002	0.275	0.156	0.015	0.25	<b>DZ156-625-250-E2F</b>
<b>0.75</b>	-0.001 -0.001 -0.002	1 1 1.125	+0.002 +0.002 +0.002	0.213 0.275 0.343	0.125 0.125 0.187	0.015 0.015 0.015	0.25 0.25 0.25	<b>DZ125-750-187-E2F</b> <b>DZ125-750-250-E2F</b> <b>DZ187-750-312-E2F</b>
<b>0.875</b>	-0.001	1.125	+0.002	0.275	0.125	0.015	0.25	<b>DZ125-875-250-E2F</b>
<b>1</b>	-0.001 -0.002	1.25 1.375	+0.002 +0.002	0.275 0.343	0.125 0.187	0.015 0.015	0.25 0.25	<b>DZ125-1000-250-E2F</b> <b>DZ187-1000-312-E2F</b>
<b>1.125</b>	-0.001 -0.002 -0.002	1.375 1.5 1.625	+0.002 +0.002 +0.003	0.275 0.343 0.413	0.125 0.187 0.25	0.015 0.015 0.02	0.25 0.25 0.312	<b>DZ125-1125-250-E2F</b> <b>DZ187-1125-312-E2F</b> <b>DZ250-1125-375-E2F</b>
<b>1.187</b>	-0.002	1.562	+0.002	0.343	0.187	0.015	0.25	<b>DZ187-1187-312-E2F</b>
<b>1.25</b>	-0.001 -0.002 -0.002 -0.002 -0.002	1.5 1.625 1.75 1.75 2	+0.002 +0.002 +0.003 +0.003 +0.005	0.275 0.343 0.413 0.618 0.688	0.125 0.187 0.25 0.25 0.375	0.015 0.015 0.02 0.02 0.03	0.25 0.25 0.312 0.312 0.5	<b>DZ125-1250-250-E2F</b> <b>DZ187-1250-312-E2F</b> <b>DZ250-1250-375-E2F</b> <b>DZ250-1250-562-E2F</b> <b>DZ375-1250-625-E2F</b>
<b>1.375</b>	-0.001 -0.002 -0.002	1.625 1.75 1.875	+0.002 +0.002 +0.003	0.343 0.343 0.413	0.125 0.187 0.25	0.015 0.015 0.02	0.25 0.25 0.312	<b>DZ125-1375-312-E2F</b> <b>DZ187-1375-312-E2F</b> <b>DZ250-1375-375-E2F</b>

Cylinder dimensions							Designation	
d	Tolerance	D	Tolerance	L +0.01	S	R max.	C min.	
in.								-
1.5	-0.001	1.75	+0.002	0.275	0.125	0.015	0.25	DZ125-1500-250-E2F
	-0.001	1.812	+0.002	0.343	0.156	0.015	0.25	DZ156-1500-312-E2F
	-0.002	1.875	+0.002	0.343	0.187	0.015	0.25	DZ187-1500-312-E2F
	-0.002	1.875	+0.002	0.413	0.187	0.015	0.25	DZ187-1500-375-E2F
	-0.002	2	+0.003	0.413	0.25	0.02	0.312	DZ250-1500-375-E2F
	-0.002	2	+0.003	0.618	0.25	0.02	0.312	DZ250-1500-562-E2F
1.625	-0.002	2	+0.002	0.343	0.187	0.015	0.25	DZ187-1625-312-E2F
	-0.002	2	+0.002	0.413	0.187	0.015	0.25	DZ187-1625-375-E2F
	-0.002	2.125	+0.003	0.413	0.25	0.02	0.312	DZ250-1625-375-E2F
1.75	-0.001	2	+0.002	0.275	0.125	0.015	0.25	DZ125-1750-250-E2F
	-0.002	2.125	+0.002	0.343	0.187	0.015	0.25	DZ187-1750-312-E2F
	-0.002	2.125	+0.002	0.413	0.187	0.015	0.25	DZ187-1750-375-E2F
	-0.002	2.25	+0.003	0.413	0.25	0.02	0.312	DZ250-1750-375-E2F
	-0.002	2.5	+0.005	0.413	0.375	0.03	0.5	DZ375-1750-375-E2F
	-0.002	2.5	+0.005	0.825	0.375	0.03	0.5	DZ375-1750-750-E2F
1.875	-0.002	2.25	+0.002	0.343	0.187	0.015	0.25	DZ187-1875-312-E2F
2	-0.002	2.375	+0.002	0.343	0.187	0.015	0.25	DZ187-2000-312-E2F
	-0.002	2.375	+0.002	0.413	0.187	0.015	0.25	DZ187-2000-375-E2F
	-0.002	2.5	+0.003	0.413	0.25	0.02	0.312	DZ250-2000-375-E2F
	-0.002	2.5	+0.003	0.618	0.25	0.02	0.312	DZ250-2000-562-E2F
2.25	-0.002	2.625	+0.002	0.343	0.187	0.015	0.25	DZ187-2250-312-E2F
	-0.002	2.625	+0.002	0.413	0.187	0.015	0.25	DZ187-2250-375-E2F
	-0.002	2.75	+0.003	0.413	0.25	0.02	0.312	DZ250-2250-375-E2F
2.375	-0.002	2.75	+0.002	0.343	0.187	0.015	0.25	DZ187-2375-312-E2F
	-0.002	2.875	+0.003	0.413	0.25	0.02	0.312	DZ250-2375-375-E2F
2.5	-0.002	2.875	+0.002	0.343	0.187	0.015	0.25	DZ187-2500-312-E2F
	-0.002	2.875	+0.002	0.413	0.187	0.015	0.25	DZ187-2500-375-E2F
	-0.002	3	+0.003	0.413	0.25	0.02	0.312	DZ250-2500-375-E2F
	-0.002	3.125	+0.004	0.55	0.312	0.02	0.312	DZ312-2500-500-E2F
	-0.002	3.25	+0.005	0.688	0.375	0.03	0.5	DZ375-2500-625-E2F
2.625	-0.002	3.125	+0.003	0.413	0.25	0.02	0.312	DZ250-2625-375-E2F
2.75	-0.002	3.125	+0.002	0.343	0.187	0.015	0.25	DZ187-2750-312-E2F
	-0.002	3.25	+0.003	0.413	0.25	0.02	0.312	DZ250-2750-375-E2F
	-0.002	3.5	+0.005	0.688	0.375	0.03	0.5	DZ375-2750-625-E2F
2.875	-0.002	3.375	+0.003	0.413	0.25	0.02	0.312	DZ250-2875-375-E2F
3	-0.002	3.375	+0.002	0.343	0.187	0.015	0.25	DZ187-3000-312-E2F
	-0.002	3.375	+0.002	0.413	0.187	0.015	0.25	DZ187-3000-375-E2F
	-0.002	3.5	+0.003	0.413	0.25	0.02	0.312	DZ250-3000-375-E2F
	-0.002	3.5	+0.003	0.618	0.25	0.02	0.312	DZ250-3000-562-E2F
	-0.002	3.625	+0.004	0.55	0.312	0.02	0.312	DZ312-3000-500-E2F
	-0.002	3.75	+0.005	0.688	0.375	0.03	0.5	DZ375-3000-625-E2F
3.125	-0.002	3.75	+0.005	0.965	0.375	0.03	0.5	DZ375-3000-875-E2F
3.125	-0.002	3.625	+0.003	0.413	0.25	0.02	0.312	DZ250-3125-375-E2F
3.187	-0.002	3.562	+0.002	0.413	0.187	0.015	0.25	DZ187-3187-375-E2F
3.25	-0.002	3.625	+0.002	0.343	0.187	0.015	0.25	DZ187-3250-312-E2F
	-0.002	3.75	+0.003	0.413	0.25	0.02	0.312	DZ250-3250-375-E2F
	-0.002	3.875	+0.004	0.55	0.312	0.02	0.312	DZ312-3250-500-E2F
	-0.002	4	+0.005	0.688	0.375	0.03	0.5	DZ375-3250-625-E2F

3.6

### 3.6 DZ profile rod seals, inch sizes d 3.375 – 12 in.

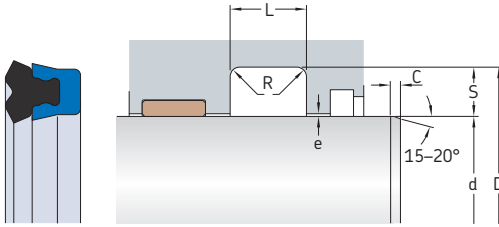

#### Maximum extrusion gap e

Radial depth	$e_{max}$ at 60 °C (140 °F) for pressures		
	2 300 psi	3 600 psi	5 800 psi
S			
in.	in.		
<b>0.125</b>	0.008	0.004	–
<b>0.156 to 0.187</b>	0.014	0.008	–
<b>0.25</b>	0.018	0.01	0.004
<b>0.312 to 0.375</b>	0.02	0.012	0.006
<b>0.5</b>	0.024	0.012	0.008

#### Cylinder dimensions

#### Designation

d	Tolerance	D	Tolerance	L +0.01	S	R max.	C min.	Designation
in.								–
3.375	-0.002 -0.002	3.875 4	+0.003 +0.004	0.413 0.55	0.25 0.312	0.02 0.02	0.312 0.312	<b>DZ250-3375-375-E2F</b> <b>DZ312-3375-500-E2F</b>
3.5	-0.002 -0.002 -0.002 -0.003	4 4.125 4.25 4.5	+0.003 +0.004 +0.005 +0.007	0.413 0.55 0.688 0.825	0.25 0.312 0.375 0.5	0.02 0.02 0.03 0.03	0.312 0.312 0.5 0.625	<b>DZ250-3500-375-E2F</b> <b>DZ312-3500-500-E2F</b> <b>DZ375-3500-625-E2F</b> <b>DZ500-3500-750-E2F</b>
3.625	-0.002 -0.002	4.375 4.375	+0.005 +0.005	0.688 0.965	0.375 0.375	0.03 0.03	0.5 0.5	<b>DZ375-3625-625-E2F</b> <b>DZ375-3625-875-E2F</b>
3.75	-0.002 -0.002 -0.002 -0.002 -0.002	4.25 4.25 4.375 4.375 4.5	+0.003 +0.003 +0.004 +0.004 +0.005	0.413 0.618 0.413 0.55 0.688	0.25 0.25 0.312 0.312 0.375	0.02 0.02 0.02 0.02 0.03	0.312 0.312 0.312 0.312 0.5	<b>DZ250-3750-375-E2F</b> <b>DZ250-3750-562-E2F</b> <b>DZ312-3750-375-E2F</b> <b>DZ312-3750-500-E2F</b> <b>DZ375-3750-625-E2F</b>
3.875	-0.002	4.375	+0.003	0.413	0.25	0.02	0.312	<b>DZ250-3875-375-E2F</b>
4	-0.002 -0.002 -0.002 -0.002 -0.002 -0.003	4.375 4.5 4.5 4.75 4.75 5	+0.002 +0.003 +0.003 +0.005 +0.005 +0.007	0.413 0.413 0.618 0.688 0.825 0.825	0.187 0.25 0.25 0.375 0.375 0.5	0.015 0.02 0.02 0.03 0.03 0.03	0.25 0.312 0.312 0.5 0.5 0.625	<b>DZ187-4000-375-E2F</b> <b>DZ250-4000-375-E2F</b> <b>DZ250-4000-562-E2F</b> <b>DZ375-4000-625-E2F</b> <b>DZ375-4000-750-E2F</b> <b>DZ500-4000-750-E2F</b>
4.25	-0.002 -0.002 -0.002	4.75 4.875 5	+0.003 +0.004 +0.005	0.413 0.618 0.688	0.25 0.312 0.375	0.02 0.02 0.03	0.312 0.312 0.5	<b>DZ250-4250-375-E2F</b> <b>DZ312-4250-562-E2F</b> <b>DZ375-4250-625-E2F</b>
4.5	-0.002 -0.002 -0.002 -0.002	5 5 5.25 5.25	+0.003 +0.003 +0.005 +0.005	0.413 0.618 0.688 0.825	0.25 0.25 0.375 0.375	0.02 0.02 0.03 0.03	0.312 0.312 0.5 0.5	<b>DZ250-4500-375-E2F</b> <b>DZ250-4500-562-E2F</b> <b>DZ375-4500-625-E2F</b> <b>DZ375-4500-750-E2F</b>
4.625	-0.002	5.125	+0.003	0.618	0.25	0.02	0.312	<b>DZ250-4625-562-E2F</b>
4.75	-0.002 -0.002 -0.002	5.125 5.25 5.5	+0.002 +0.003 +0.005	0.413 0.618 0.688	0.187 0.25 0.375	0.015 0.02 0.03	0.25 0.312 0.5	<b>DZ187-4750-375-E2F</b> <b>DZ250-4750-562-E2F</b> <b>DZ375-4750-625-E2F</b>



Cylinder dimensions								Designation
d	Tolerance	D	Tolerance	L +0.01	S	R max.	C min.	
in.								-
5	-0.002	5.5	+0.003	0.413	0.25	0.02	0.312	DZ250-5000-375-E2F
	-0.002	5.5	+0.003	0.618	0.25	0.02	0.312	DZ250-5000-562-E2F
	-0.002	5.75	+0.005	0.688	0.375	0.03	0.5	DZ375-5000-625-E2F
5.25	-0.002	5.75	+0.003	0.618	0.25	0.02	0.312	DZ250-5250-562-E2F
5.375	-0.002	5.875	+0.003	0.413	0.25	0.02	0.312	DZ250-5375-375-E2F
5.5	-0.002	5.875	+0.002	0.413	0.187	0.015	0.25	DZ187-5500-375-E2F
	-0.002	6	+0.003	0.618	0.25	0.02	0.312	DZ250-5500-562-E2F
	-0.002	6.25	+0.005	0.688	0.375	0.03	0.5	DZ375-5500-625-E2F
5.75	-0.002	6.25	+0.003	0.413	0.25	0.02	0.312	DZ250-5750-375-E2F
	-0.002	6.5	+0.005	0.688	0.375	0.03	0.5	DZ375-5750-625-E2F
6	-0.002	6.5	+0.003	0.413	0.25	0.02	0.312	DZ250-6000-375-E2F
	-0.002	6.5	+0.003	0.618	0.25	0.02	0.312	DZ250-6000-562-E2F
	-0.002	6.75	+0.005	0.688	0.375	0.03	0.5	DZ375-6000-625-E2F
	-0.003	7	+0.007	0.825	0.5	0.03	0.625	DZ500-6000-750-E2F
6.375	-0.002	6.875	+0.003	0.55	0.25	0.02	0.312	DZ250-6375-500-E2F
6.5	-0.002	7	+0.003	0.413	0.25	0.02	0.312	DZ250-6500-375-E2F
	-0.002	7	+0.003	0.618	0.25	0.02	0.312	DZ250-6500-562-E2F
	-0.002	7.25	+0.005	0.688	0.375	0.03	0.5	DZ375-6500-625-E2F
6.75	-0.002	7.25	+0.003	0.618	0.25	0.02	0.312	DZ250-6750-562-E2F
7	-0.002	7.5	+0.003	0.413	0.25	0.02	0.312	DZ250-7000-375-E2F
	-0.002	7.75	+0.005	0.688	0.375	0.03	0.5	DZ375-7000-625-E2F
	-0.003	8	+0.007	0.825	0.5	0.03	0.625	DZ500-7000-750-E2F
7.25	-0.002	7.75	+0.003	0.55	0.25	0.02	0.312	DZ250-7250-500-E2F
7.5	-0.002	8.25	+0.005	0.688	0.375	0.03	0.5	DZ375-7500-625-E2F
7.75	-0.002	8.5	+0.005	0.55	0.375	0.03	0.5	DZ375-7750-500-E2F
8	-0.002	8.75	+0.005	0.688	0.375	0.03	0.5	DZ375-8000-625-E2F
	-0.003	9	+0.007	0.825	0.5	0.03	0.625	DZ500-8000-750-E2F
8.125	-0.002	8.625	+0.003	0.413	0.25	0.02	0.312	DZ250-8125-375-E2F
	-0.002	8.625	+0.003	0.55	0.25	0.02	0.312	DZ250-8125-500-E2F
	-0.002	8.625	+0.003	0.618	0.25	0.02	0.312	DZ250-8125-562-E2F
8.25	-0.002	9	+0.005	0.688	0.375	0.03	0.5	DZ375-8250-625-E2F
8.5	-0.003	9.5	+0.007	0.825	0.5	0.03	0.625	DZ500-8500-750-E2F
8.875	-0.002	9.5	+0.004	0.55	0.312	0.02	0.312	DZ312-8875-500-E2F
9	-0.002	9.75	+0.005	0.688	0.375	0.03	0.5	DZ375-9000-625-E2F
	-0.003	10	+0.007	0.825	0.5	0.03	0.625	DZ500-9000-750-E2F
9.25	-0.002	10	+0.005	0.618	0.375	0.03	0.5	DZ375-9250-562-E2F
10.5	-0.002	11.25	+0.005	0.688	0.375	0.03	0.5	DZ375-10500-625-E2F
10.75	-0.002	11.5	+0.005	0.688	0.375	0.03	0.5	DZ375-10750-625-E2F
11	-0.003	12	+0.007	0.825	0.5	0.03	0.625	DZ500-11000-750-E2F
12	-0.003	13	+0.007	0.825	0.5	0.03	0.625	DZ500-12000-750-E2F

Other sizes are available on request

## DZR profile data



<b>Materials</b>	<p>Primary sealing lip: LT NBR 70A, A-8504          Secondary sealing lip: TPU 95A, U-1003          Anti-extrusion ring: PA P-2506          For additional information → <b>page 26</b></p>
<b>Pressure</b>	Up to 690 bar ( <i>10 000 psi</i> )
<b>Speed</b>	Up to 1 m/s ( <i>3.2 ft/s</i> )
<b>Temperature range</b>	<p> <span style="color: blue;">■</span> Extreme low temperature range: seal performance depends on system design (precision guiding arrangement recommended)  <span style="color: green;">■</span> <b>Recommended operating temperature range for this profile and material</b>  <span style="color: yellow;">■</span> Temperatures above the recommended operating range: acceptable only with reduced pressure and/or speed  <span style="color: red;">■</span> Extreme high temperature range: only occasional short term exposure (e.g. cylinder in curing oven of a powder coating process)         </p>
<b>Counter-surface</b>	→ <b>page 22</b>

Maximum values of application parameters (e.g. pressure, speed, temperature, e-gap) should not be applied continuously nor simultaneously.

### 3.7 DZR profile rod seals, metric sizes d 40 – 150 mm

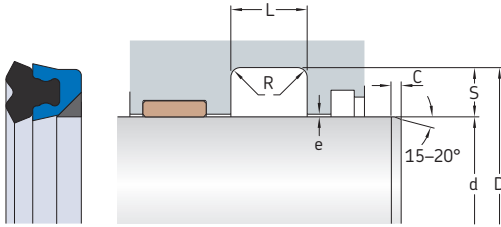

#### Maximum extrusion gap e

Radial depth  $e_{\max}$  at 80 °C (175 °F)  
for pressures

S	$e_{\max}$ at 80 °C (175 °F) for pressures			
	160 bar	250 bar	400 bar	690 bar
mm	mm			
5	0,55	0,35	0,2	0,1
7,5	0,8	0,5	0,3	0,15
10 to 11	1,1	0,75	0,45	0,2

3.7

#### Cylinder dimensions

#### Designation

d h9	D H9	L +0,2	S	R max.	C min.	Designation
mm						-
40	50	8	5	0,2	6	DZR-40x50x8-E2E
50	60	8	5	0,2	6	DZR-50x60x8-E2E
56	71	11,7	7,5	0,5	8,5	DZR-56x71x11.7-E2E
63	78	11,7	7,5	0,5	8,5	DZR-63x78x11.7-E2E
75	95	16,5	10	0,8	11	DZR-75x95x16.5-E2D
85	100	13,8	7,5	0,5	8,5	DZR-85x100x13.8-E2E
110	125	12,5	7,5	0,5	8,5	DZR-110x125x12.5-E2D
150	172	16,5	11	0,8	13	DZR-150x172x16.5-E2D

Other sizes are available on request

### 3.7 DZR profile rod seals, inch sizes d 1.25 – 12 in.

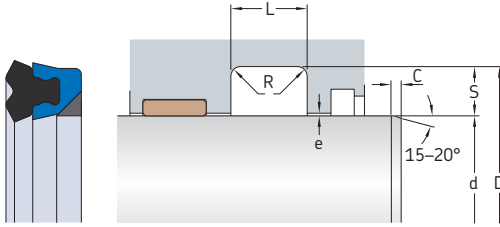

#### Maximum extrusion gap e

Radial depth	$e_{\max}$ at 80 °C (175 °F) for pressures			
	2 300 psi	3 600 psi	5 800 psi	10 000 psi
S				
in.	in.			
<b>0.187</b>	0.021	0.013	0.008	0.005
<b>0.25</b>	0.028	0.018	0.011	0.007
<b>0.312</b>	0.044	0.028	0.017	0.01
<b>0.375</b>	0.044	0.028	0.017	0.01
<b>0.5</b>	0.059	0.038	0.023	0.014

#### Cylinder dimensions

#### Designation

d	Tolerance	D	Tolerance	L +0.01	S	R max.	C min.	
in.								-
<b>1.25</b>	-0.002 -0.002	1.625 1.750	+0.002 +0.003	0.343 0.413	0.187 0.25	0.015 0.02	0.250 0.312	<b>DZR187-1250-312-E2E</b> <b>DZR250-1250-375-E2E</b>
<b>1.5</b>	-0.002 -0.002	1.875 2.000	+0.002 +0.003	0.343 0.413	0.187 0.25	0.015 0.02	0.250 0.312	<b>DZR187-1500-312-E2E</b> <b>DZR250-1500-375-E2E</b>
<b>1.75</b>	-0.002	2.250	+0.003	0.413	0.25	0.02	0.312	<b>DZR250-1750-375-E2E</b>
<b>2</b>	-0.002 -0.002	2.500 2.750	+0.003 +0.005	0.413 0.688	0.25 0.375	0.02 0.03	0.312 0.500	<b>DZR250-2000-375-E2E</b> <b>DZR375-2000-625-E2E</b>
<b>2.25</b>	-0.002	2.750	+0.003	0.413	0.25	0.02	0.312	<b>DZR250-2250-375-E2E</b>
<b>2.375</b>	-0.002	2.875	+0.003	0.413	0.25	0.02	0.312	<b>DZR250-2375-375-E2D</b>
<b>2.5</b>	-0.002	3.000	+0.003	0.413	0.25	0.02	0.312	<b>DZR250-2500-375-E2E</b>
<b>2.625</b>	-0.002	3.125	+0.003	0.413	0.25	0.02	0.312	<b>DZR250-2625-375-E2E</b>
<b>2.75</b>	-0.002	3.250	+0.003	0.413	0.25	0.02	0.312	<b>DZR250-2750-375-E2E</b>
<b>3</b>	-0.002 -0.002 -0.002	3.374 3.500 3.750	+0.003 +0.003 +0.005	0.413 0.413 0.688	0.187 0.25 0.375	0.015 0.02 0.03	0.250 0.312 0.500	<b>DZR187-3000-375-E2D</b> <b>DZR250-3000-375-E2E</b> <b>DZR375-3000-625-E2E</b>
<b>3.5</b>	-0.002 -0.002	4.000 4.250	+0.003 +0.005	0.413 0.688	0.25 0.375	0.02 0.03	0.312 0.500	<b>DZR250-3500-375-E2E</b> <b>DZR375-3500-625-E2E</b>
<b>3.625</b>	-0.002 -0.002	4.125 4.375	+0.003 +0.005	0.413 0.688	0.25 0.375	0.02 0.03	0.312 0.500	<b>DZR250-3625-375-E2E</b> <b>DZR375-3625-625-E2E</b>
<b>3.75</b>	-0.002	4.250	+0.003	0.413	0.25	0.02	0.312	<b>DZR250-3750-375-E2E</b>
<b>3.875</b>	-0.002	4.375	+0.003	0.413	0.25	0.02	0.312	<b>DZR250-3875-375-E2D</b>
<b>4</b>	-0.002 -0.002 -0.002 -0.002 -0.002	4.500 4.500 4.625 4.625 4.750	+0.003 +0.003 +0.004 +0.004 +0.005	0.413 0.618 0.550 0.618 0.688	0.25 0.25 0.312 0.312 0.375	0.02 0.02 0.02 0.02 0.03	0.312 0.312 0.312 0.312 0.500	<b>DZR250-4000-375-E2E</b> <b>DZR250-4000-562-E2E</b> <b>DZR312-4000-500-E2E</b> <b>DZR312-4000-562-E2E</b> <b>DZR375-4000-625-E2E</b>

Cylinder dimensions								Designation
d	Tolerance	D	Tolerance	L +0.01	S	R max.	C min.	
in.								-
4.25	-0.002	5.000	+0.005	0.688	0.375	0.03	0.500	DZR375-4250-625-E2E
4.375	-0.002	4.875	+0.003	0.413	0.25	0.02	0.312	DZR250-4375-375-E2D
4.5	-0.002	5.000	+0.003	0.413	0.25	0.02	0.312	DZR250-4500-375-E2E
	-0.002	5.250	+0.005	0.688	0.375	0.03	0.500	DZR375-4500-625-E2E
4.875	-0.002	5.375	+0.003	0.413	0.25	0.02	0.312	DZR250-4875-375-E2D
5	-0.002	5.500	+0.003	0.413	0.25	0.02	0.312	DZR250-5000-375-E2E
	-0.002	5.500	+0.003	0.618	0.25	0.02	0.312	DZR250-5000-562-E2E
	-0.002	5.750	+0.005	0.688	0.375	0.03	0.500	DZR375-5000-625-E2E
5.25	-0.002	6.000	+0.005	0.688	0.375	0.03	0.500	DZR375-5250-625-E2E
5.5	-0.002	6.000	+0.003	0.413	0.25	0.02	0.312	DZR250-5500-375-E2E
	-0.002	6.250	+0.005	0.688	0.375	0.03	0.500	DZR375-5500-625-E2E
6	-0.002	6.750	+0.005	0.688	0.375	0.03	0.500	DZR375-6000-625-E2E
	-0.003	7.000	+0.007	0.825	0.5	0.03	0.625	DZR500-6000-750-E2E
6.5	-0.002	7.250	+0.005	0.688	0.375	0.03	0.500	DZR375-6500-625-E2E
	-0.003	7.500	+0.007	0.825	0.5	0.03	0.625	DZR500-6500-750-E2E
6.75	-0.002	7.500	+0.005	0.688	0.375	0.03	0.500	DZR375-6750-625-E2E
7	-0.002	7.750	+0.005	0.688	0.375	0.03	0.500	DZR375-7000-625-E2E
	-0.003	8.000	+0.007	0.825	0.5	0.03	0.625	DZR500-7000-750-E2E
7.25	-0.002	8.000	+0.005	0.688	0.375	0.03	0.500	DZR375-7250-625-E2D
7.5	-0.002	8.250	+0.005	0.688	0.375	0.03	0.500	DZR375-7500-625-E2D
7.75	-0.002	8.500	+0.005	0.688	0.375	0.03	0.500	DZR375-7750-625-E2D
7.875	-0.002	8.625	+0.005	0.688	0.375	0.03	0.500	DZR375-7875-625-E2D
8	-0.002	8.750	+0.005	0.688	0.375	0.03	0.500	DZR375-8000-625-E2E
	-0.003	9.000	+0.007	0.825	0.5	0.03	0.625	DZR500-8000-750-E2E
8.5	-0.003	9.500	+0.007	0.825	0.5	0.03	0.625	DZR500-8500-750-E2E
9	-0.002	9.750	+0.005	0.688	0.375	0.03	0.500	DZR375-9000-625-E2D
11	-0.002	11.750	+0.005	0.688	0.375	0.03	0.500	DZR375-11000-625-E2D
	-0.003	12.000	+0.007	0.825	0.5	0.03	0.625	DZR500-11000-750-E2D
12	-0.002	12.750	+0.005	0.688	0.375	0.03	0.500	DZR375-12000-625-E2D

Other sizes are available on request

## RBB profile data



<b>Materials</b>	Sealing ring: TPU 93A, U-1023 Anti-extrusion ring: metric sizes → POM P-2518 inch sizes → PA P-2506 For additional information → <b>page 26</b>
<b>Pressure</b>	Up to 690 bar (10 000 psi)
<b>Speed</b>	Up to 1 m/s (3.2 ft/s)
<b>Temperature range</b>	<div style="display: flex; align-items: center;"> <div style="margin-left: 10px;"> <p>                     -60      -40      -30      110    120    130 [°C]                      -75      -40      -20      230    250    265 [°F]                 </p> </div> </div> <ul style="list-style-type: none"> <li><span style="display: inline-block; width: 15px; height: 15px; background-color: #0070C0; margin-right: 5px;"></span> Extreme low temperature range: may be intermittently exposed (e.g. cold start-up) without seal damage, but seal performance may be compromised while in this range</li> <li><span style="display: inline-block; width: 15px; height: 15px; background-color: #808080; margin-right: 5px;"></span> Temperatures below the recommended operating range: seal performance depends on system design (precision guiding arrangement recommended)</li> <li><span style="display: inline-block; width: 15px; height: 15px; background-color: #008000; margin-right: 5px;"></span> <b>Recommended operating temperature range for this profile and material</b></li> <li><span style="display: inline-block; width: 15px; height: 15px; background-color: #FFD700; margin-right: 5px;"></span> Temperatures above the recommended operating range: acceptable only with reduced pressure and/or speed</li> <li><span style="display: inline-block; width: 15px; height: 15px; background-color: #FF0000; margin-right: 5px;"></span> Extreme high temperature range: only occasional short term exposure (e.g. cylinder in curing oven of a powder coating process)</li> </ul>
<b>Dimension standards</b>	Some metric sizes fit seal housings in accordance with ISO 7425-2.
<b>Counter-surface</b>	→ <b>page 22</b>

Maximum values of application parameters (e.g. pressure, speed, temperature, e-gap) should not be applied continuously nor simultaneously.

### 3.8 RBB profile buffer seals, metric sizes d 25 – 110 mm

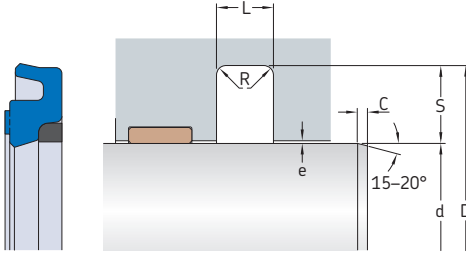

#### Maximum extrusion gap e

Radial depth S	$e_{\max}$ at 80 °C (175 °F) for pressures			
	160 bar	250 bar	400 bar	690 bar
mm	mm			
5,35	0,6	0,4	0,25	0,1
7,55 to 7,75	0,8	0,55	0,35	0,15

#### Cylinder dimensions

#### Designation

d h9	D H9	L +0,2	S	R max.	C min.	
mm						-
25	35,7	4,2	5,35	0,55	6	RBB-25x35.7x4.2-J0S
30	40,7	4,2	5,35	0,55	6	RBB-30x40.7x4.2-J0S
35	45,7	4,2	5,35	0,55	6	RBB-35x45.7x4.2-J0S
40	55,1	6,3	7,55	0,7	8	RBB-40x55.1x6.3-J0S
50	65,1	6,3	7,55	0,7	8	RBB-50x65.1x6.3-J0S
55	70,1	6,3	7,55	0,7	8	RBB-55x70.1x6.3-J0S
	70,5	6,3	7,75	0,7	8	RBB-55x70.5x6.3-J0S
60	75,1	6,3	7,55	0,7	8	RBB-60x75.1x6.3-J0S
65	80,1	6,3	7,55	0,7	8	RBB-65x80.1x6.3-J0S
	80,5	6,3		0,7	8	RBB-65x80.5x6.3-J0S
70	85,1	6,3	7,55	0,7	8	RBB-70x85.1x6.3-J0S
	85,5	6,3	7,75	0,7	8	• RBB-70x85.5x6.3-J0S
75	90,1	6,3	7,55	0,7	8	RBB-75x90.1x6.3-J0S
	90,5	6,3	7,75	0,7	8	RBB-75x90.5x6.3-J0S
80	95,1	6,3	7,55	0,7	8	RBB-80x95.1x6.3-J0S
85	100,1	6,3	7,55	0,7	8	RBB-85x100.1x6.3-J0S
90	105,1	6,3	7,55	0,7	8	RBB-90x105.1x6.3-J0S
	105,5	6,3	7,75	0,7	8	• RBB-90x105.5x6.3-J0S
95	110,1	6,3	7,55	0,7	8	RBB-95x110.1x6.3-J0S
	110,5	6,3	7,75	0,7	8	RBB-95x110.5x6.3-J0S
100	115,1	6,3	7,55	0,7	8	RBB-100x115.1x6.3-J0S
105	120,1	6,3	7,55	0,7	8	RBB-105x120.1x6.3-J0S
110	125,1	6,3	7,55	0,7	8	RBB-110x125.1x6.3-J0S

• Seal housing dimensions in accordance with ISO 7425-2

### 3.8 RBB profile buffer seals, metric sizes d 115 – 170 mm

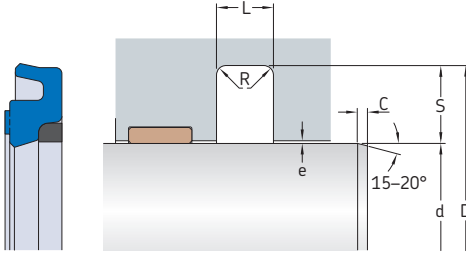

#### Maximum extrusion gap e

Radial depth S	$e_{\max}$ at 80 °C (175 °F) for pressures			
	160 bar	250 bar	400 bar	690 bar
mm	mm			
5,35 7,55 to 7,75	0,6 0,8	0,4 0,55	0,25 0,35	0,1 0,15

#### Cylinder dimensions

#### Designation

d h9	D H9	L +0,2	S	R max.	C min.
mm					

115	130,1	6,3	7,55	0,7	8	RBB-115x130.1x6.3-J0S
120	135,1	6,3	7,55	0,7	8	RBB-120x135.1x6.3-J0S
125	140,1	6,3	7,55	0,7	8	RBB-125x140.1x6.3-J0S
130	145,1	6,3	7,55	0,7	8	RBB-130x145.1x6.3-J0S
140	155,1	6,3	7,55	0,7	8	RBB-140x155.1x6.3-J0S
150	165,1	6,3	7,55	0,7	8	RBB-150x165.1x6.3-J0S
170	185,1	6,3	7,55	0,7	8	RBB-170x185.1x6.3-J0S

Other sizes are available on request



### 3.8 RBB profile buffer seals, inch sizes d 2 – 8 in.

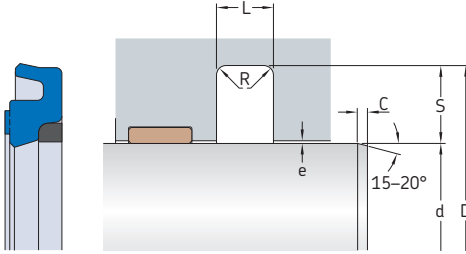

#### Maximum extrusion gap e

Radial depth S	Series	$e_{\max}$ at 80 °C (175 °F) for pressures			
		2 300 psi	3 600 psi	5 800 psi	10 000 psi
in.	-	in.			
<b>0.166</b>	<b>2</b>	0.019	0.012	0.008	0.004
<b>0.247</b>	<b>3</b>	0.029	0.019	0.012	0.005
<b>0.320</b>	<b>4</b>	0.037	0.024	0.015	0.007

#### Cylinder dimensions

d	Tolerance	D	Tolerance	L +0.01	S	R max.	C min.	Series	Designation
								-	-
in.								-	-
2	-0.004	2.494	+0.005	0.247	0.308	0.028	0.312	3	RBB3-2000-E6T
2.25	-0.003	2.582	+0.004	0.166	0.212	0.022	0.25	2	RBB2-2250-E6T
2.5	-0.003	2.832	+0.004	0.166	0.212	0.022	0.25	2	RBB2-2500-E6T
	-0.004	2.994	+0.005	0.247	0.308	0.028	0.312	3	RBB3-2500-E6T
2.75	-0.004	3.244	+0.005	0.247	0.308	0.028	0.312	3	RBB3-2750-E6T
3	-0.004	3.494	+0.005	0.247	0.308	0.028	0.312	3	RBB3-3000-E6T
3.5	-0.004	3.994	+0.005	0.247	0.308	0.028	0.312	3	RBB3-3500-E6T
4	-0.004	4.494	+0.005	0.247	0.308	0.028	0.312	3	RBB3-4000-E6T
4.5	-0.004	4.994	+0.005	0.247	0.308	0.028	0.312	3	RBB3-4500-E6T
4.75	-0.004	5.244	+0.005	0.247	0.308	0.028	0.312	3	RBB3-4750-E6T
5	-0.004	5.494	+0.005	0.247	0.308	0.028	0.312	3	RBB3-5000-E6T
5.5	-0.004	5.994	+0.005	0.247	0.308	0.028	0.312	3	RBB3-5500-E6T
6	-0.004	6.494	+0.005	0.247	0.308	0.028	0.312	3	RBB3-6000-E6T
6.5	-0.004	6.994	+0.005	0.247	0.308	0.028	0.312	3	RBB3-6500-E6T
7	-0.004	7.494	+0.005	0.247	0.308	0.028	0.312	3	RBB3-7000-E6T
7.25	-0.004	7.744	+0.005	0.247	0.308	0.028	0.312	3	RBB3-7250-E6T
8	-0.004	8.494	+0.005	0.247	0.308	0.028	0.312	3	RBB3-8000-E6T

Other sizes are available on request

## S9B profile data



<b>Materials</b>	O-ring energizer: NBR A-8501 Slide ring: PTFE 741 or X-ECOPUR For additional information → <b>page 26</b>
<b>Pressure</b>	X-ECOPUR slide ring → up to 600 bar (8 700 psi) PTFE 741 slide ring → up to 400 bar (5 800 psi)
<b>Speed</b>	Up to 2 m/s (6.5 ft/s)
<b>Temperature range</b>	<p>With PTFE 741 slide ring:</p> <p>Temperature range: -40 to 120 °C (-40 to 250 °F)</p> <p>With X-ECOPUR slide ring:</p> <p>Temperature range: -40 to 130 °C (-40 to 265 °F)</p> <ul style="list-style-type: none"> <li> Extreme low temperature range: may be intermittently exposed (e.g. cold start-up) without seal damage, but seal performance may be compromised while in this range</li> <li> Temperatures below the recommended operating range: seal performance depends on system design (precision guiding arrangement recommended)</li> <li> <b>Recommended operating temperature range for this profile and these materials</b></li> <li> Temperatures above the recommended operating range: acceptable only with reduced pressure, speed, and/or e-gap</li> <li> Extreme high temperature range: only occasional short term exposure (e.g. cylinder in curing oven of a powder coating process)</li> </ul>
<b>Counter-surface</b>	→ <b>page 22</b>

Maximum values of application parameters (e.g. pressure, speed, temperature, e-gap) should not be applied continuously nor simultaneously.

### 3.9 S9B profile buffer seals, metric sizes d 8 – 40 mm

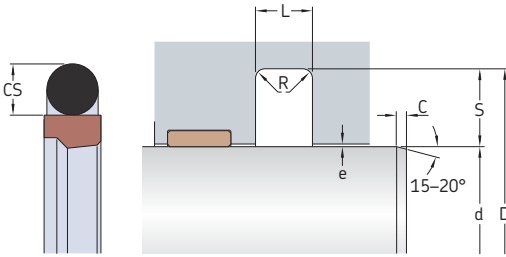

#### Maximum extrusion gap e with X-ECOPUR slide ring

Radial depth S	$e_{\max}$ at 80 °C (175 °F) for pressures			
	160 bar	250 bar	400 bar	600 bar
mm	mm			
3,65	0,4	0,3	0,2	0,1
5,35	0,5	0,4	0,3	0,2
7,55	0,5	0,4	0,3	0,2
10,25	0,7	0,5	0,4	0,2

#### Maximum extrusion gap e with PTFE slide ring

Radial depth S	$e_{\max}$ at 80 °C (175 °F) for pressures		
	160 bar	250 bar	400 bar
mm	mm		
3,65	0,35	0,25	0,15
5,35	0,4	0,3	0,2
7,55	0,5	0,35	0,25
10,25	0,6	0,45	0,35

#### Cylinder dimensions

d	D	L	S	R	C	CS
f8	H9	+0,2		max.	min.	nom.
mm						

#### Designations

With slide ring made of  
X-ECOPUR

PTFE 741

8	15,3	3,2	3,65	0,6	3,5	2,62	S9B-8x15,3x3,2	S9B-8x15,3x3,2-AD1
10	17,3	3,2	3,65	0,6	3,5	2,62	S9B-10x17,3x3,2	S9B-10x17,3x3,2-AD1
14	21,3	3,2	3,65	0,6	3,5	2,62	S9B-14x21,3x3,2	S9B-14x21,3x3,2-AD1
16	23,3	3,2	3,65	0,6	3,5	2,62	S9B-16x23,3x3,2	S9B-16x23,3x3,2-AD1
18	25,3	3,2	3,65	0,6	3,5	2,62	S9B-18x25,3x3,2	S9B-18x25,3x3,2-AD1
20	30,7	4,2	5,35	1	4,5	3,53	S9B-20x30,7x4,2	S9B-20x30,7x4,2-AD1
25	35,7	4,2	5,35	1	4,5	3,53	S9B-25x35,7x4,2	S9B-25x35,7x4,2-AD1
28	38,7	4,2	5,35	1	4,5	3,53	S9B-28x38,7x4,2	S9B-28x38,7x4,2-AD1
32	42,7	4,2	5,35	1	4,5	3,53	S9B-32x42,7x4,2	S9B-32x42,7x4,2-AD1
35	45,7	4,2	5,35	1	4,5	3,53	S9B-35x45,7x4,2	S9B-35x45,7x4,2-AD1
36	46,7	4,2	5,35	1	4,5	3,53	S9B-36x46,7x4,2	S9B-36x46,7x4,2-AD1
40	55,1	6,3	7,55	1,3	5	5,33	S9B-40x55,1x6,3	S9B-40x55,1x6,3-AD1



### 3.9 S9B profile buffer seals, metric sizes

d 45 – 240 mm

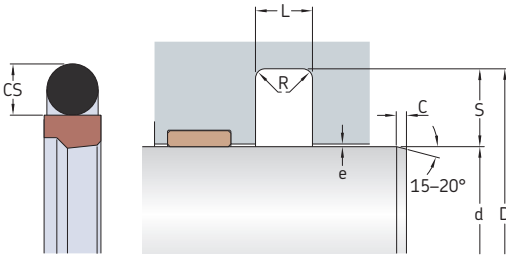

#### Maximum extrusion gap e with X-ECOPUR slide ring

Radial depth S	$e_{\max}$ at 80 °C (175 °F) for pressures			
	160 bar	250 bar	400 bar	600 bar
mm	mm			
3,65	0,4	0,3	0,2	0,1
5,35	0,5	0,4	0,3	0,2
7,55	0,5	0,4	0,3	0,2
10,25	0,7	0,5	0,4	0,2

#### Maximum extrusion gap e with PTFE slide ring

Radial depth S	$e_{\max}$ at 80 °C (175 °F) for pressures		
	160 bar	250 bar	400 bar
mm	mm		
3,65	0,35	0,25	0,15
5,35	0,4	0,3	0,2
7,55	0,5	0,35	0,25
10,25	0,6	0,45	0,35

#### Cylinder dimensions

d	D	L	S	R	C	CS
f8	H9	+0,2		max.	min.	nom.
mm						

#### Designations

With slide ring made of  
X-ECOPUR

PTFE 741

45	60,1	6,3	7,55	1,3	5	5,33	S9B-45x60,1x6,3	S9B-45x60,1x6,3-AD1
50	65,1	6,3	7,55	1,3	5	5,33	S9B-50x65,1x6,3	S9B-50x65,1x6,3-AD1
55	70,1	6,3	7,55	1,3	5	5,33	S9B-55x70,1x6,3	S9B-55x70,1x6,3-AD1
63	78,1	6,3	7,55	1,3	5	5,33	S9B-63x78,1x6,3	S9B-63x78,1x6,3-AD1
75	90,1	6,3	7,55	1,3	5	5,33	S9B-75x90,1x6,3	S9B-75x90,1x6,3-AD1
80	95,1	6,3	7,55	1,3	5	5,33	S9B-80x95,1x6,3	S9B-80x95,1x6,3-AD1
90	105,1	6,3	7,55	1,3	5	5,33	S9B-90x105,1x6,3	S9B-90x105,1x6,3-AD1
100	115,1	6,3	7,55	1,3	5	5,33	S9B-100x115,1x6,3	S9B-100x115,1x6,3-AD1
110	125,1	6,3	7,55	1,3	5	5,33	S9B-110x125,1x6,3	S9B-110x125,1x6,3-AD1
125	140,1	6,3	7,55	1,3	5	5,33	S9B-125x140,1x6,3	S9B-125x140,1x6,3-AD1
140	155,1	6,3	7,55	1,3	5	5,33	S9B-140x155,1x6,3	S9B-140x155,1x6,3-AD1
160	175,1	6,3	7,55	1,3	5	5,33	S9B-160x175,1x6,3	S9B-160x175,1x6,3-AD1

**Cylinder dimensions****Designations**  
With slide ring made of  
X-ECOPUR

PTFE 741

d f8	D H9	L +0,2	S	R max.	C min.	CS nom.		
mm							-	
<b>180</b>	195,1	6,3	7,55	1,3	5	5,33	<b>S9B-180x195,1x6,3</b>	<b>S9B-180x195,1x6,3-AD1</b>
<b>200</b>	215,1	6,3	7,55	1,3	5	5,33	<b>S9B-200x215,1x6,3</b>	<b>S9B-200x215,1x6,3-AD1</b>
<b>240</b>	260,5	8,1	10,25	1,8	6	7	<b>S9B-240x260,5x8,1</b>	<b>S9B-240x260,5x8,1-AD1</b>

**Other sizes are available on request**

### 3.9 S9B profile buffer seals, inch sizes d 1 – 10 in.

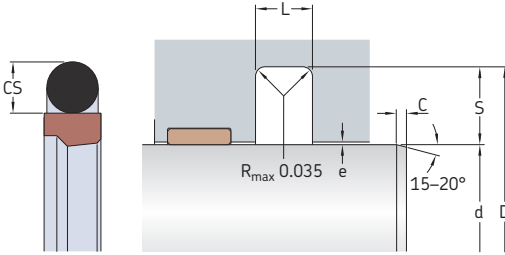

#### Maximum extrusion gap e with X-ECOPUR slide ring

Radial depth S	$e_{\max}$ at 80 °C (175 °F) for pressures			
	2 300 psi	3 600 psi	5 800 psi	8 700 psi
in.	in.			
<b>0.149</b>	0.016	0.012	0.008	0.004
<b>0.212</b>	0.02	0.016	0.012	0.008
<b>0.308</b>	0.02	0.016	0.012	0.008
<b>0.415</b>	0.028	0.02	0.016	0.008

#### Maximum extrusion gap e with PTFE slide ring

Radial depth S	$e_{\max}$ at 80 °C (175 °F) for pressures		
	2 300 psi	3 600 psi	5 800 psi
in.	in.		
<b>0.149</b>	0,014	0,01	0,006
<b>0.212</b>	0,016	0,012	0,008
<b>0.308</b>	0,020	0,014	0,01
<b>0.415</b>	0,024	0,018	0,014

#### Cylinder dimensions

**Designations**  
With slide ring made of  
X-ECOPUR PTFE 741

d	Tolerance	D	Tolerance	L +0.01	S	C min.	CS nom.		
in.								-	
<b>1</b>	-0.002	1.298	+0.003	0.126	0.149	0.14	0.103	<b>S9B1-1000</b>	<b>S9B1-1000-AD1</b>
	-0.003	1.424	+0.004	0.166	0.212	0.18	0.139	<b>S9B2-1000</b>	<b>S9B2-1000-AD1</b>
<b>1.125</b>	-0.002	1.423	+0.003	0.126	0.149	0.14	0.103	<b>S9B1-1125</b>	<b>S9B1-1125-AD1</b>
<b>1.25</b>	-0.002	1.548	+0.003	0.126	0.149	0.14	0.103	<b>S9B1-1250</b>	<b>S9B1-1250-AD1</b>
	-0.003	1.674	+0.004	0.166	0.212	0.18	0.139	<b>S9B2-1250</b>	<b>S9B2-1250-AD1</b>
<b>1.375</b>	-0.003	1.799	+0.004	0.166	0.212	0.18	0.139	<b>S9B2-1375</b>	<b>S9B2-1375-AD1</b>
<b>1.5</b>	-0.002	1.798	+0.003	0.126	0.149	0.14	0.103	<b>S9B1-1500</b>	<b>S9B1-1500-AD1</b>
	-0.003	1.924	+0.004	0.166	0.212	0.18	0.139	<b>S9B2-1500</b>	<b>S9B2-1500-AD1</b>
	-0.004	2.116	+0.005	0.247	0.308	0.2	0.21	<b>S9B3-1500</b>	<b>S9B3-1500-AD1</b>
<b>1.75</b>	-0.002	2.048	+0.003	0.126	0.149	0.14	0.103	<b>S9B1-1750</b>	<b>S9B1-1750-AD1</b>
	-0.003	2.174	+0.004	0.166	0.212	0.18	0.139	<b>S9B2-1750</b>	<b>S9B2-1750-AD1</b>
	-0.004	2.366	+0.005	0.247	0.308	0.2	0.21	<b>S9B3-1750</b>	<b>S9B3-1750-AD1</b>
<b>1.875</b>	-0.003	2.299	+0.004	0.166	0.212	0.18	0.139	<b>S9B2-1875</b>	<b>S9B2-1875-AD1</b>
	-0.004	2.424	+0.005	0.247	0.308	0.2	0.21	<b>S9B3-2000</b>	<b>S9B3-2000-AD1</b>
<b>2</b>	-0.003	2.424	+0.004	0.166	0.212	0.18	0.139	<b>S9B2-2000</b>	<b>S9B2-2000-AD1</b>
	-0.004	2.616	+0.005	0.247	0.308	0.2	0.21	<b>S9B3-2000</b>	<b>S9B3-2000-AD1</b>
<b>2.25</b>	-0.003	2.674	+0.004	0.166	0.212	0.18	0.139	<b>S9B2-2250</b>	<b>S9B2-2250-AD1</b>
	-0.004	2.866	+0.005	0.247	0.308	0.2	0.21	<b>S9B3-2250</b>	<b>S9B3-2250-AD1</b>
<b>2.5</b>	-0.003	2.924	+0.004	0.166	0.212	0.18	0.139	<b>S9B2-2500</b>	<b>S9B2-2500-AD1</b>
	-0.004	3.116	+0.005	0.247	0.308	0.2	0.21	<b>S9B3-2500</b>	<b>S9B3-2500-AD1</b>
<b>2.625</b>	-0.004	3.241	+0.005	0.247	0.308	0.2	0.21	<b>S9B3-2625</b>	<b>S9B3-2625-AD1</b>
	-0.003	3.049	+0.004	0.166	0.212	0.18	0.139	<b>S9B2-2750</b>	<b>S9B2-2750-AD1</b>
	-0.004	3.241	+0.005	0.247	0.308	0.2	0.21	<b>S9B3-2750</b>	<b>S9B3-2750-AD1</b>

Cylinder dimensions								Designations With slide ring made of X-ECOPUR PTFE 741	
d	Tolerance	D	Tolerance	L +0.01	S	C min.	CS nom.		
in.								-	
3	-0.003	3.424	+0.004	0.166	0.212	0.18	0.139	S9B2-3000	S9B2-3000-AD1
	-0.004	3.616	+0.005	0.247	0.308	0.2	0.21	S9B3-3000	S9B3-3000-AD1
3.25	-0.004	3.866	+0.005	0.247	0.308	0.2	0.21	S9B3-3250	S9B3-3250-AD1
3.5	-0.004	4.116	+0.005	0.247	0.308	0.2	0.21	S9B3-3500	S9B3-3500-AD1
3.75	-0.004	4.366	+0.005	0.247	0.308	0.2	0.21	S9B3-3750	S9B3-3750-AD1
4	-0.003	4.424	+0.004	0.166	0.212	0.18	0.139	S9B2-4000	S9B2-4000-AD1
	-0.004	4.616	+0.005	0.247	0.308	0.2	0.21	S9B3-4000	S9B3-4000-AD1
	-0.005	4.83	+0.006	0.32	0.415	0.25	0.275	S9B4-4000	S9B4-4000-AD1
4.25	-0.004	4.866	+0.005	0.247	0.308	0.2	0.21	S9B3-4250	S9B3-4250-AD1
	-0.005	5.08	+0.006	0.32	0.415	0.25	0.275	S9B4-4250	S9B4-4250-AD1
4.5	-0.004	5.116	+0.005	0.247	0.308	0.2	0.21	S9B3-4500	S9B3-4500-AD1
	-0.005	5.33	+0.006	0.32	0.415	0.25	0.275	S9B4-4500	S9B4-4500-AD1
4.75	-0.004	5.366	+0.005	0.247	0.308	0.2	0.21	S9B3-4750	S9B3-4750-AD1
	-0.005	5.58	+0.006	0.32	0.415	0.25	0.275	S9B4-4750	S9B4-4750-AD1
5	-0.004	5.616	+0.005	0.247	0.308	0.2	0.21	S9B3-5000	S9B3-5000-AD1
	-0.005	5.83	+0.006	0.32	0.415	0.25	0.275	S9B4-5000	S9B4-5000-AD1
5.25	-0.004	5.866	+0.005	0.247	0.308	0.2	0.21	S9B3-5250	S9B3-5250-AD1
	-0.005	6.08	+0.006	0.32	0.415	0.25	0.275	S9B4-5250	S9B4-5250-AD1
5.5	-0.004	6.116	+0.005	0.247	0.308	0.2	0.21	S9B3-5500	S9B3-5500-AD1
	-0.005	6.33	+0.006	0.32	0.415	0.25	0.275	S9B4-5500	S9B4-5500-AD1
5.75	-0.004	6.366	+0.005	0.247	0.308	0.2	0.21	S9B3-5750	S9B3-5750-AD1
	-0.005	6.58	+0.006	0.32	0.415	0.25	0.275	S9B4-5750	S9B4-5750-AD1
6	-0.004	6.616	+0.005	0.247	0.308	0.2	0.21	S9B3-6000	S9B3-6000-AD1
	-0.005	6.83	+0.006	0.32	0.415	0.25	0.275	S9B4-6000	S9B4-6000-AD1
6.25	-0.004	6.866	+0.005	0.247	0.308	0.2	0.21	S9B3-6250	S9B3-6250-AD1
	-0.005	7.08	+0.006	0.32	0.415	0.25	0.275	S9B4-6250	S9B4-6250-AD1
6.5	-0.004	7.116	+0.005	0.247	0.308	0.2	0.21	S9B3-6500	S9B3-6500-AD1
	-0.005	7.33	+0.006	0.32	0.415	0.25	0.275	S9B4-6500	S9B4-6500-AD1
6.75	-0.004	7.366	+0.005	0.247	0.308	0.2	0.21	S9B3-6750	S9B3-6750-AD1
	-0.005	7.58	+0.006	0.32	0.415	0.25	0.275	S9B4-6750	S9B4-6750-AD1
7	-0.004	7.616	+0.005	0.247	0.308	0.2	0.21	S9B3-7000	S9B3-7000-AD1
	-0.005	7.83	+0.006	0.32	0.415	0.25	0.275	S9B4-7000	S9B4-7000-AD1
7.25	-0.004	7.866	+0.005	0.247	0.308	0.2	0.21	S9B3-7250	S9B3-7250-AD1
	-0.005	8.08	+0.006	0.32	0.415	0.25	0.275	S9B4-7250	S9B4-7250-AD1
7.5	-0.004	8.116	+0.005	0.247	0.308	0.2	0.21	S9B3-7500	S9B3-7500-AD1
	-0.005	8.33	+0.006	0.32	0.415	0.25	0.275	S9B4-7500	S9B4-7500-AD1
7.75	-0.004	8.366	+0.005	0.247	0.308	0.2	0.21	S9B3-7750	S9B3-7750-AD1
	-0.005	8.58	+0.006	0.32	0.415	0.25	0.275	S9B4-7750	S9B4-7750-AD1
8	-0.004	8.616	+0.005	0.247	0.308	0.2	0.21	S9B3-8000	S9B3-8000-AD1
	-0.005	8.83	+0.006	0.32	0.415	0.25	0.275	S9B4-8000	S9B4-8000-AD1
8.5	-0.005	9.33	+0.006	0.32	0.415	0.25	0.275	S9B4-8500	S9B4-8500-AD1
9	-0.005	9.83	+0.006	0.32	0.415	0.25	0.275	S9B4-9000	S9B4-9000-AD1
9.5	-0.005	10.33	+0.006	0.32	0.415	0.25	0.275	S9B4-9500	S9B4-9500-AD1
10	-0.005	10.83	+0.006	0.32	0.415	0.25	0.275	S9B4-10000	S9B4-10000-AD1

Other sizes are available on request



## RSB profile data



<b>Materials</b>	Energizer: NBA 70A, A-8501 Slide ring: 40% bronze PTFE 741 For additional information → <b>page 26</b>
<b>Pressure</b>	Up to 400 bar (5 800 psi)
<b>Speed</b>	Up to 1 m/s (3.2 ft/s)
<b>Temperature range</b>	<div style="display: flex; align-items: center;"> <div style="margin-left: 10px;"> <p> <span style="color: blue;">■</span> Extreme low temperature range: may be intermittently exposed (e.g. cold start-up) without seal damage, but seal performance may be compromised while in this range  <span style="color: gray;">■</span> Temperatures below the recommended operating range: seal performance depends on system design (precision guiding arrangement recommended)  <span style="color: green;">■</span> <b>Recommended operating temperature range for this profile and material</b>  <span style="color: red;">■</span> Extreme high temperature range: only occasional short term exposure (e.g. cylinder in curing oven of a powder coating process)                 </p> </div> </div>
<b>Dimension standards</b>	Some sizes fit seal grooves in accordance with ISO 7425-1.
<b>Counter-surface</b>	→ <b>page 22</b>

Maximum values of application parameters (e.g. pressure, speed, temperature, e-gap) should not be applied continuously nor simultaneously.



### 3.10 RSB profile buffer seals, inch sizes d 1.25 – 6 in.

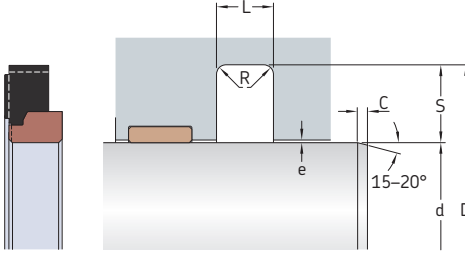

#### Maximum extrusion gap e

Radial depth S	Series	e <sub>max</sub> at 80 °C (175 °F) for pressures		
		2 300 psi	3 600 psi	5 800 psi
in.	-	in.		
0.166	2	0.014	0.01	0.008
0.247	3	0.018	0.012	0.008
0.32	4	0.02	0.014	0.01

#### Cylinder dimensions

#### Designation

d	Tolerance	D	Tolerance	L +0.01	S	R max.	C min.	Series	Designation
in.									-
1.25	-0.003	1.582	+0.004	0.166	0.212	0.022	0.25	2	RSB2-1250-AD2
1.5	-0.003	1.832	+0.004	0.166	0.212	0.022	0.25	2	RSB2-1500-AD2
	-0.004	1.994	+0.005	0.247	0.308	0.028	0.312	3	RSB3-1500-AD2
1.75	-0.003	2.082	+0.004	0.166	0.212	0.022	0.25	2	RSB2-1750-AD2
2	-0.004	2.494	+0.005	0.247	0.308	0.028	0.312	3	RSB3-2000-AD2
2.25	-0.003	2.582	+0.004	0.166	0.212	0.022	0.25	2	RSB2-2250-AD2
	-0.004	2.744	+0.005	0.247	0.308	0.028	0.312	3	RSB3-2250-AD2
2.375	-0.004	2.869	+0.005	0.247	0.308	0.028	0.312	3	RSB3-2375-AD2
2.5	-0.003	2.832	+0.004	0.166	0.212	0.022	0.25	2	RSB2-2500-AD2
	-0.004	2.994	+0.005	0.247	0.308	0.028	0.312	3	RSB3-2500-AD2
2.75	-0.004	3.244	+0.005	0.247	0.308	0.028	0.312	3	RSB3-2750-AD2
3	-0.004	3.494	+0.005	0.247	0.308	0.028	0.312	3	RSB3-3000-AD2
3.25	-0.004	3.744	+0.005	0.247	0.308	0.028	0.312	3	RSB3-3250-AD2
3.5	-0.004	3.994	+0.005	0.247	0.308	0.028	0.312	3	RSB3-3500-AD2
3.75	-0.004	4.244	+0.005	0.247	0.308	0.028	0.312	3	RSB3-3750-AD2
4	-0.004	4.494	+0.005	0.247	0.308	0.028	0.312	3	RSB3-4000-AD2
4.5	-0.004	4.994	+0.005	0.247	0.308	0.028	0.312	3	RSB3-4500-AD2
	-0.005	5.14	+0.006	0.32	0.415	0.035	0.312	4	RSB4-4500-AD2
5	-0.004	5.494	+0.005	0.247	0.308	0.028	0.312	3	RSB3-5000-AD2
	-0.005	5.64	+0.006	0.32	0.415	0.035	0.312	4	RSB4-5000-AD2
5.25	-0.004	5.744	+0.005	0.247	0.308	0.028	0.312	3	RSB3-5250-AD2
5.5	-0.004	5.994	+0.005	0.247	0.308	0.028	0.312	3	RSB3-5500-AD2
6	-0.004	6.494	+0.005	0.247	0.308	0.028	0.312	3	RSB3-6000-AD2
	-0.005	6.64	+0.006	0.32	0.415	0.035	0.312	4	RSB4-6000-AD2

### 3.10 RSB profile buffer seals, inch sizes d 6.5 – 13 in.

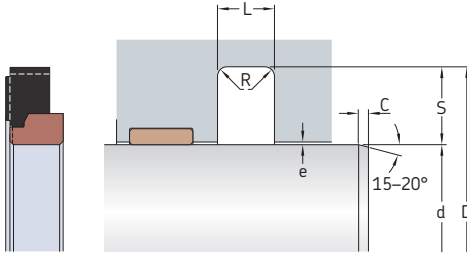

#### Maximum extrusion gap e

Radial Series  $e_{max}$  at 80 °C (175 °F)  
depth S for pressures  
2 300 psi 3 600 psi 5 800 psi

in.	-	in.		
<b>0.166</b>	2	0.014	0.01	0.008
<b>0.247</b>	3	0.018	0.012	0.008
<b>0.32</b>	4	0.02	0.014	0.01

#### Cylinder dimensions

#### Designation

d	Tolerance	D	Tolerance	L	S	R	C	Series	Designation
in.				+0.01		max.	min.		-
<b>6.5</b>	-0.005	7.14	+0.006	0.32	0.415	0.035	0.312	4	<b>RSB4-6500-AD2</b>
<b>7</b>	-0.004	7.494	+0.005	0.247	0.308	0.028	0.312	3	<b>RSB3-7000-AD2</b>
	-0.005	7.64	+0.006	0.32	0.415	0.035	0.312	4	<b>RSB4-7000-AD2</b>
<b>8</b>	-0.004	8.494	+0.005	0.247	0.308	0.028	0.312	3	<b>RSB3-8000-AD2</b>
	-0.005	8.64	+0.006	0.32	0.415	0.035	0.312	4	<b>RSB4-8000-AD2</b>
<b>8.5</b>	-0.004	8.994	+0.005	0.247	0.308	0.028	0.312	3	<b>RSB3-8500-AD2</b>
<b>9</b>	-0.005	9.64	+0.006	0.32	0.415	0.035	0.312	4	<b>RSB4-9000-AD2</b>
<b>10</b>	-0.005	10.64	+0.006	0.32	0.415	0.035	0.312	4	<b>RSB4-10000-AD2</b>
<b>10.5</b>	-0.004	10.994	+0.005	0.247	0.308	0.028	0.312	3	<b>RSB3-10500-AD2</b>
<b>11</b>	-0.005	11.64	+0.006	0.32	0.415	0.035	0.312	4	<b>RSB4-11000-AD2</b>
<b>13</b>	-0.004	13.494	+0.005	0.247	0.308	0.028	0.312	3	<b>RSB3-13000-AD2</b>
	-0.005	13.64	+0.006	0.32	0.415	0.035	0.312	4	<b>RSB4-13000-AD2</b>

Other sizes are available on request



## Rod and buffer seals

### More rod and buffer seals

The rod and buffer seals listed in this catalogue represent the preferred profiles in common sizes. SKF supplies many additional sizes and profiles and provides customized solutions for the toughest application conditions. The following profiles are also manufactured in series production. For additional information about these profiles or if the application requires a solution not provided in this catalogue, contact SKF.

#### Rod locking T-seals

LTR profiles (→ **fig. 15**) are T-seals for rod applications with a rubber sealing ring supported by patented locking anti-extrusion rings on both sides. Therefore, they can be used as double-acting rod seals for special applications. For example, in tandem cylinders that require a rod seal to take pressure from both sides. For additional information about materials and sizes, contact SKF.

#### TEFLATHANE seals

These rod seals of various designs and material combinations incorporate an anti-extrusion ring that is bonded into the body. They are suitable for high temperature and/or short-stroke applications. For example, U-cup seals made of special high temperature polyurethane bonded to a PTFE anti-extrusion ring in rock hammer applications (→ **fig. 16**). For additional information about materials and sizes, contact SKF.

#### Chevron sets

These moulded or machined chevron sets (→ **fig. 17**) are available in a wide variety of materials and designs. They are also called "vee packings" and typically consist of a header ring, one or several chevron rings, and a base ring. These rings can be made of different materials to achieve their own specific functional benefits. For additional information about designs, materials and sizes, contact SKF.

Fig. 15

Rod locking T-seal

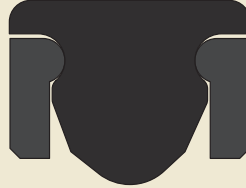

LTR

Fig. 16

TEFLATHANE seal example

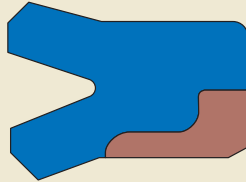
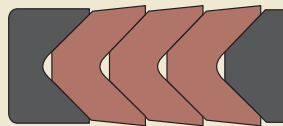

Fig. 17

Chevron set example



## SPECTRASEAL

SPECTRASEAL is a PTFE seal that can be used as a single-acting rod seal (→ **fig. 18**). The metal spring energizer adds radial load to the seal lip contact areas. SPECTRASEAL is intended for extreme condition applications including high temperature or aggressive media. For additional information, contact SKF.

Fig. 18

SPECTRASEAL

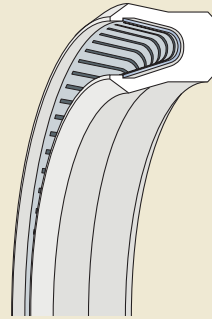

## Rod and buffer seals

### Customized machined seal profiles

SKF can manufacture a wide variety of rod seal profiles with different materials and sizes with its industry-leading SKF SEAL JET production system (→ **fig. 19**). For additional information about customized machined profiles, refer to publication *Customized machined seals – Product range* or contact SKF.

Fig. 19

SKF SEAL JET profile examples



S01-P



S01-R



S02-P



S02-PD



S02-R



S02-RD



S02-S

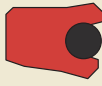

S03-P

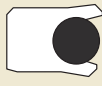

S03-F

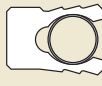

S03-S



S04-P



S04-PD



S05-P



S05-R



S06-P



S06-R



S07-P

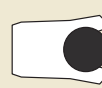

S07-F



S08-P



S08-PE



S08-R



S09-E



S09-ES



S09-D



S09-DS



S09-P



S1012-T



S1012-M



S1315-T



S16-A



S16-B



S17-P



S17-R



S18-P



S18-R

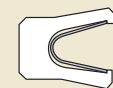

S19-F



S20-R



S21-P



S22-P

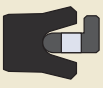

S22-R



S24-P



S2527-F



S2931-F



S32-P



S35-P

3

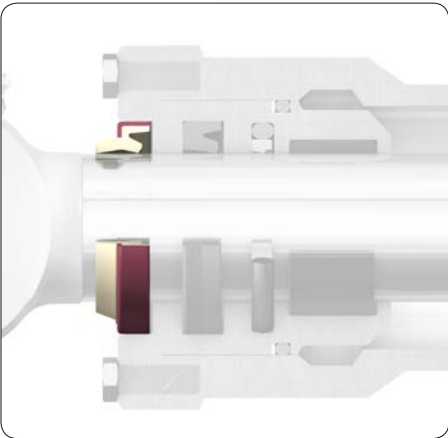
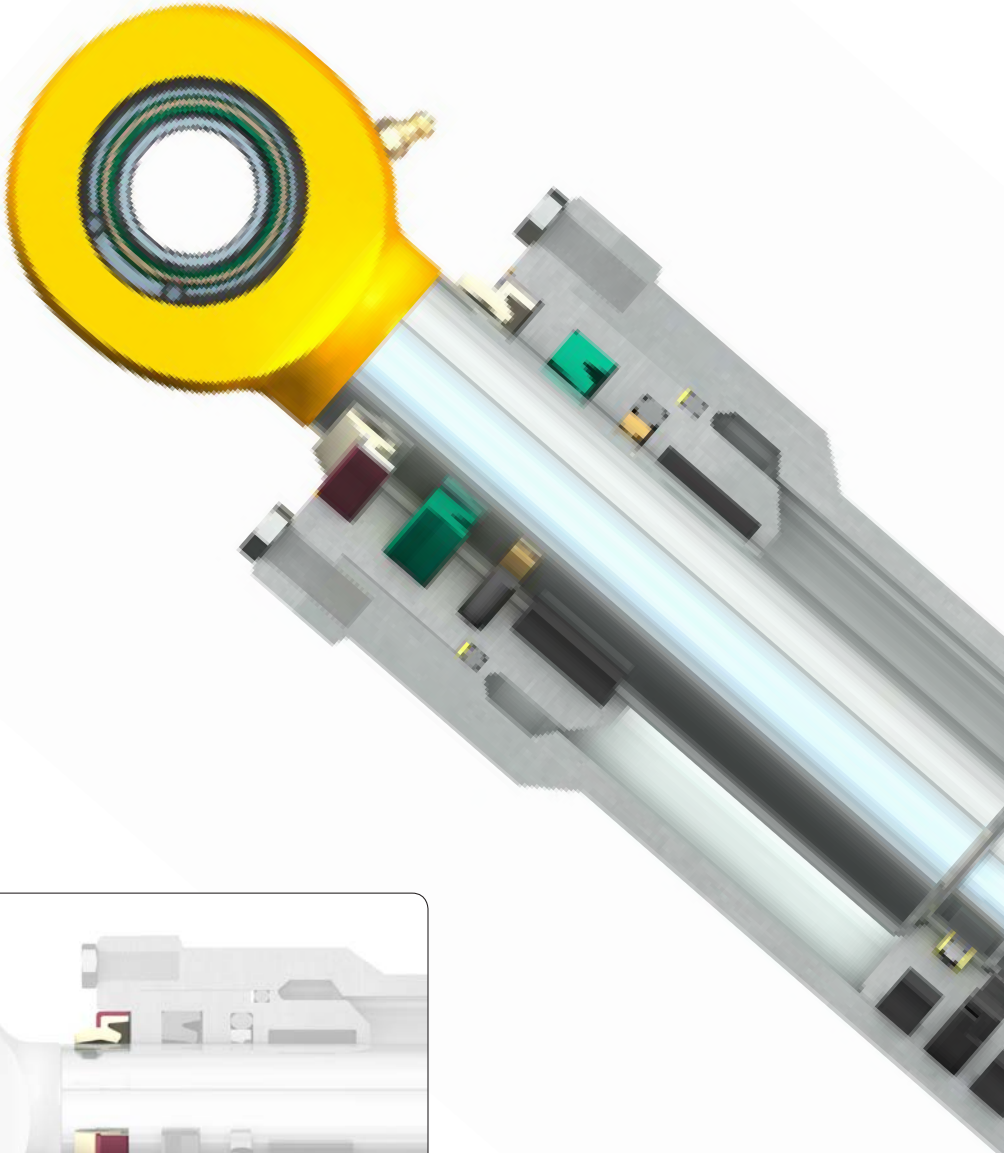









# Wiper seals

<b>Profile overview</b> .....	<b>208</b>	<b>Profile data</b>	
<b>Basics</b> .....	<b>210</b>	<b>4.1 PA</b> .....	216
Installation .....	210	Metric sizes .....	217
Materials .....	211	<b>4.2 MCW</b> .....	220
		Metric sizes .....	221
		Inch sizes .....	223
<b>Press-in wiper seals</b> .....	<b>211</b>	<b>4.3 PAD and PADV</b> .....	226
PA profiles .....	211	Metric sizes .....	227
MCW profiles .....	212	<b>4.4 DTW</b> .....	228
PAD and PADV profiles .....	212	Metric sizes .....	229
		Inch sizes .....	232
<b>Snap-in wiper seals</b> .....	<b>213</b>	<b>4.5 DX</b> .....	236
DTW profiles .....	214	Inch sizes .....	237
DX profiles .....	214	<b>4.6 HW</b> .....	240
HW profiles .....	215	Metric sizes .....	241
		Inch sizes .....	243
		<b>More wiper seals</b> .....	<b>246</b>
		Wiper seals made of PTFE .....	246
		Rod seals used as wiper seals .....	246
		Customized machined seal profiles .....	246

## Profile overview

Profile	Description	Additional information → page	Profile data → page
<b>PA</b> 	Press-in wiper; steel sleeve; single-lip design; lip protrudes from head; small radial cross section; suitable for heavy-duty applications	<b>211</b>	<b>216</b> (metric)
<b>MCW</b> 	Press-in wiper; steel sleeve; aggressive single-lip design; sits flush with head	<b>216</b>	<b>220</b> (metric and inch)
<b>PAD</b> 	Press-in wiper; steel sleeve; double-lip design improves rod sealing system performance	<b>212</b>	<b>226</b> (metric)
<b>PADV</b> 	PAD with a vent in the inside-facing lip	<b>212</b>	<b>226</b> (metric)
<b>DTW</b> 	Snap-in wiper; single-lip design; static seal lips on the outside surface and outside face; vents in the inside edge	<b>214</b>	<b>228</b> (metric and inch)
<b>DX</b> 	Snap-in wiper; single-lip design; patented profile for heavy duty applications; vents in the inside edge	<b>214</b>	<b>236</b> (inch)
<b>HW</b> 	Snap-in wiper; double-lip design improves rod sealing system performance	<b>215d</b>	<b>240</b> (metric and inch)



### Basics

Hydraulic cylinders operate in a variety of applications and environmental conditions, including exposure to dust, debris or outside weather conditions. To prevent these contaminants from entering the cylinder assembly and hydraulic system, wiper seals (also known as scrapers, excluders or dust seals) are fitted on the external side of the cylinder head (→ fig. 1).

Wiper seals maintain sealing contact to the piston rod when the equipment is stationary (static, no reciprocating motion of rod) and in use (dynamic, reciprocating rod). Without a wiper seal, the retracting piston rod could transport contaminants into the cylinder.

The outside static sealing of the wiper within the groove is also important to avoid moisture or particles from entering around the outside of the wiper seal.

Fig. 1

Wiper in typical rod seal arrangement for medium duty hydraulic applications

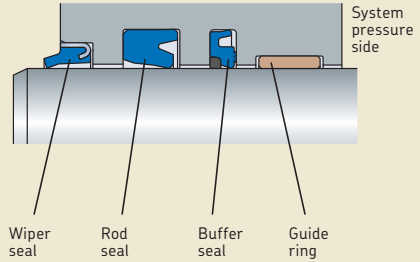

### Installation

Housings for wiper seals are typically designed either with open or stepped housing grooves (→ fig. 2).

Wipers for open grooves are encased in a steel sleeve and pressed into the groove. Therefore, they are called press-in wipers.

Wipers for stepped grooves do not have metal components and can usually be deformed by hand for installation. They “snap” into the groove and, therefore, are called snap-in wipers.

For additional information about installation, refer to *Installing wiper seals* (→ page 43).

#### More information

Counter-surface finish properties . . . . .	22
Materials . . . . .	26
Hydraulic fluids . . . . .	31
Gap extrusion . . . . .	34
Storage . . . . .	36
Installation and assembly . . . . .	38

Fig. 2

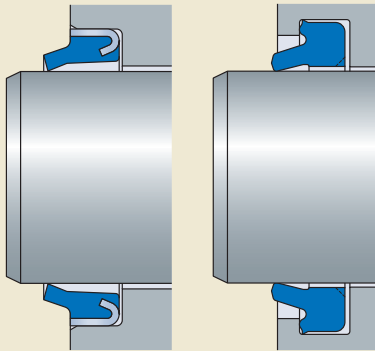
Open groove  
(press-in wiper)Stepped groove  
(snap-in wiper)

## Press-in wiper seals

Press-in wiper seals provide a robust static sealing on the outside surface by the steel sleeve that is pressed into the cylinder head. The polyurethane (TPU) wiper lip is bonded to the drawn sheet steel sleeve and maintains a sealing force by tension as well as cantilever action (flexing) to the seal lips. This ensures robust preload of the wiper lips even under minor radial misalignments between the rod and head. Press-in wiper seals are available with a single-lip or double-lip design.

### PA profiles

PA profiles (→ **fig. 3**) have an aggressive single wiping lip that protrudes from the head. This design allows small radial cross sections and reduces the risk of contaminant adherence on the wiper lip. PA profiles are suitable for heavy duty off-highway applications and are available in metric sizes.

### Materials

Polyurethane (TPU) is the most common material for wiper seals in modern hydraulic seal applications. SKF wiper seals made of TPU are developed for wear resistance and flexibility as well as with the right physical properties to aggressively remove contaminants. SKF can supply wipers in a wide variety of materials, including rubber elastomers and PTFE (→ *More wiper seals*, **page 246**).

For additional information, refer to *Materials* (→ **page 26**).

Fig. 3

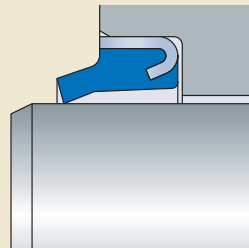

PA

## Wiper seals

### MCW profiles

MCW profiles (→ **fig. 4**) have an aggressive single wiping lip that does not protrude from the head. This allows compact arrangement when the cylinder is retracted. These profiles are available in metric and inch sizes.

### PAD and PADV profiles

PAD profiles (→ **fig. 5**) have a double-lip design with an internal-facing wiper lip that regulates the lubrication film on the rod. The internal lip wipes excess fluid film from the rod on extending stroke and allows this excess fluid to return under the rod seal on the retracting stroke. Double-acting wipers, therefore, improve the performance and extend the service life of rod sealing systems.

However, excess system pressure acting on the internal-facing lip, such as fluid passing a damaged rod seal, could overcome the press force between the groove and the steel sleeve and push the wiper out of the groove. Therefore, SKF recommends using double-acting wipers in combination with U-cup rod seals with a single-lip design, such as S1S profile (→ *Rod seals*, **page 116**), to ensure pressurised fluid can return to the hydraulic system. Retaining hardware, such as a snap ring, may also be required to retain the wiper in the groove in case of minor pressure build up (→ **fig. 6**).

PAD profiles (→ **fig. 7**) are also available with a vent in the internal lip (designation PADV). They do not need extra retaining hardware in most applications. The vent prevents pressure build up on the internal-facing lip. PAD and PADV profiles are available in the same metric sizes.

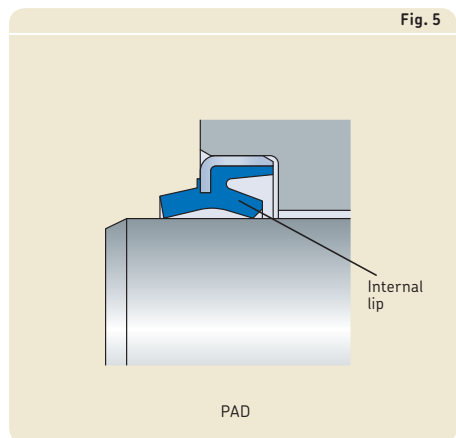
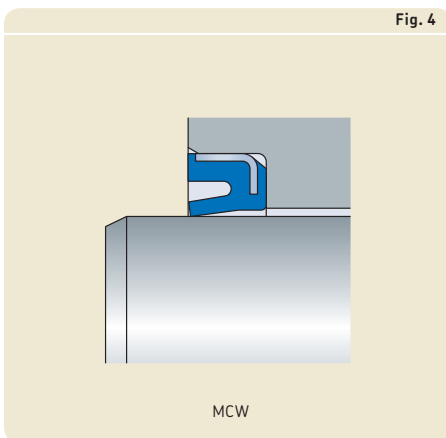
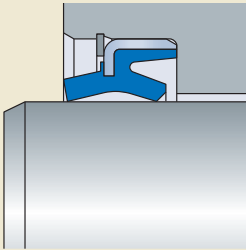
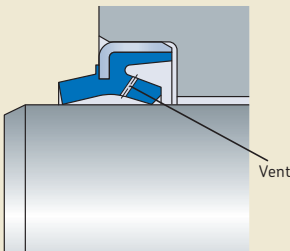

Fig. 6



PAD with snap ring

Fig. 7



PADV

Fig. 8

## Snap in wiper loose in the groove

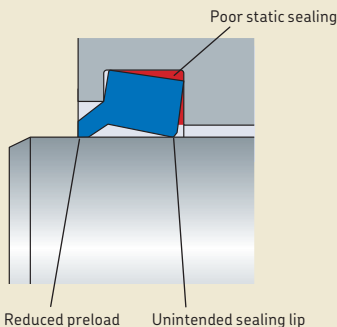

## Snap-in wiper seals

Snap-in wiper seals are easy to install without any special equipment. They do not have metal components and are typically less expensive than press-in wipers.

A common problem with snap-in wipers is that they become loose in the groove resulting in poor static sealing on the outside surface and reduced preload on the dynamic wiper lip (→ **fig. 8**). Furthermore, if the inside edge of the wiper could contact the rod, it may become an unintended sealing lip (→ **fig. 8**) and could trap pressure between the rod seal and wiper. Therefore, SKF snap-in wipers have special sealing and venting features to help ensure proper operation.

## Wiper seals

### DTW profiles

DTW profiles (→ **fig. 9**) have a single-lip design and radial static seal lip on the outside surface that maintains a positive sealing contact. An axial static seal lip on the external side face keeps the wiper tight in the groove and also serves as an additional static seal. Vents on the inside edge prevent the wiper trapping pressure or being pushed out by pressure in the event the rod seal has become damaged or has exceeded its service life. These profiles are available in metric and inch sizes.

### DX profiles

DX wipers (→ **fig. 10**) have a patented profile with a single external lip design and vented inside edge. These profiles incorporate a rubber O-ring that maintains a robust static sealing contact in the groove. The O-ring also serves as an energizer and provides robust and long term preload on the dynamic wiper lip. In case of radial misalignment, the entire TPU wiper ring follows these radial movements (“floating” design) as the relatively soft and flexible rubber O-ring energizer deforms to compensate.

When the wiper lip encounters resistance from contaminants adhered to the retracting rod (e.g. tree sap or frozen rain), the profile reacts by twisting to increase the preload on the dynamic wiper lip.

Therefore, DX profiles include the functionality of press-in wipers as well as the convenience of snap-in wipers. These profiles are available in inch sizes.

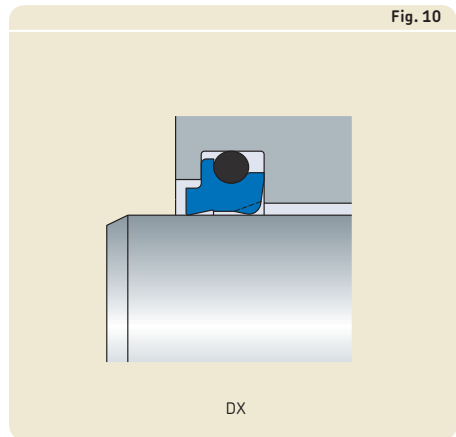
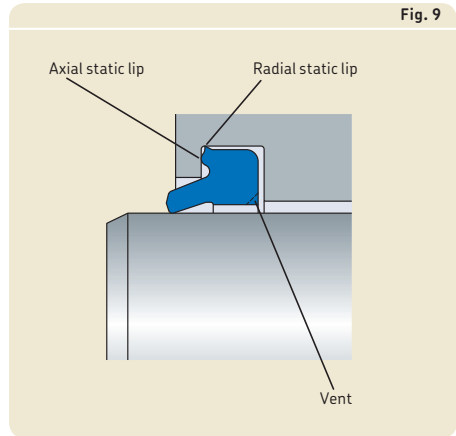
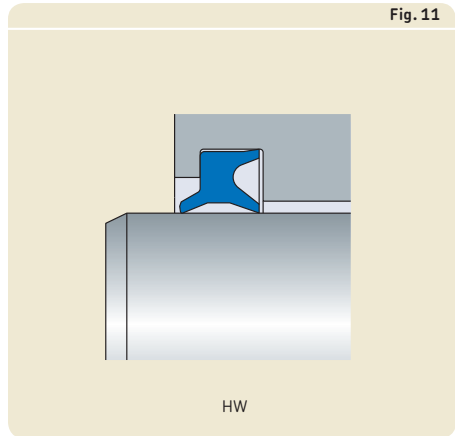



Fig. 11

## HW profiles

HW profiles (→ **fig. 11**) have a double-lip design with an internal-facing wiper lip that regulates the lubrication film on the rod. The internal lip wipes any excess fluid film from the rod on the extending stroke and allow this excess fluid to return under the rod seal on the retracting stroke. Double-acting wipers, therefore, improve the performance and extend the service life of rod sealing systems. SKF recommends using double-acting wipers in combination with U-cup rod seals with a single-lip design, such as S1S profile (→ *Rod seals*, **page 116**), to ensure pressurised fluid can return to the hydraulic system.



### PA profile data



<b>Material</b>	TPU W93 For additional information → <b>page 26</b>
<b>Speed</b>	Up to 1 m/s (3.2 ft/s)
<b>Temperature range</b>	-40 to +110 °C (-40 to +230 °F)
<b>Dimension standards</b>	Some sizes fit seal housings in accordance with ISO 6195-B.
<b>Counter-surface</b>	→ <b>page 22</b>

Maximum values of application parameters (e.g. speed, temperature) should not be applied continuously nor simultaneously.

## 4.1 PA profile wiper seals, metric sizes d 12 – 65 mm

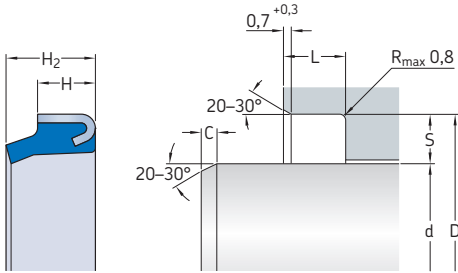

Cylinder dimensions					Seal dimensions		Designation
d	D	L	S	C	H	H <sub>2</sub>	
f7	H8	±0,25		min.		+1	
mm					mm		-
12	20	4,5	4	3	4	6	PA 12x20x4x6
20	30	7,5	5	4	7	10	• PA 20x30x7x10
25	35	7,5	5	4	7	10	• PA 25x35x7x10
28	38	7,5	5	4	7	10	• PA 28x38x7x10
30	40	7,5	5	4	7	10	PA 30x40x7x10
32	42	7,5	5	4	7	10	• PA 32x42x7x10
	45	7,5	6,5	5	7	10	PA 32x45x7x10
35	45	7,5	5	4	7	10	PA 35x45x7x10
36	45	7,5	4,5	4	7	10	PA 36x45x7x10
	46	7,5	5	4	7	10	• PA 36x46x7x10
40	50	7,5	5	4	7	10	• PA 40x50x7x10
45	55	7,5	5	4	7	10	• PA 45x55x7x10
	60	7,5	7,5	6	7	10	PA 45x60x7x10
50	60	7,5	5	4	7	10	• PA 50x60x7x10
	65	7,5	7,5	6	7	10	PA 50x65x7x10
55	65	7,5	5	4	7	10	PA 55x65x7x10
	70	7,5	7,5	6	7	10	PA 55x70x7x10
56	66	7,5	5	4	7	10	• PA 56x66x7x10
60	70	7,5	5	4	7	10	PA 60x70x7x10
63	73	7,5	5	4	7	10	• PA 63x73x7x10
	75	7,5	6	4	7	10	PA 63x75x7x10
	78	7,5	7,5	6	7	10	PA 63x78x7x10
65	75	7,5	5	4	7	10	PA 65x75x7x10

• Seal housing dimensions in accordance with ISO 6195-B

## 4.1 PA profile wiper seals, metric sizes

d 70 – 180 mm

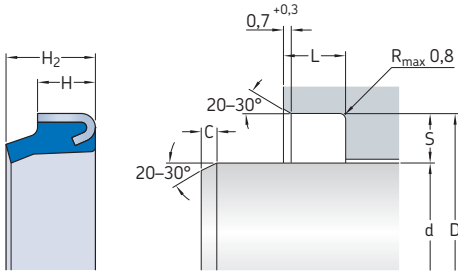

Cylinder dimensions					Seal dimensions		Designation
d	D	L	S	C	H	H <sub>2</sub>	
f7	H8	±0,25		min.		+1	
mm					mm		-
70	80	7,5	5	4	7	10	• PA 70x80x7x10
75	85	7,5	5	4	7	10	PA 75x85x7x10
80	90	7,5	5	4	7	10	• PA 80x90x7x10
85	95	7,5	5	4	7	10	PA 85x95x7x10
90	100	7,5	5	4	7	10	• PA 90x100x7x10
100	110	7,5	5	4	7	10	PA 100x110x7x10
105	115	7,5	5	4	7	10	PA 105x115x7x10
110	120	7,5	5	4	7	10	PA 110x120x7x10
115	125	7,5	5	4	7	10	PA 115x125x7x10
120	130	7,5	5	4	7	10	PA 120x130x7x10
125	140	9,5	7,5	7	9	12	• PA 125x140x9x12
140	155	9,5	7,5	7	9	12	• PA 140x155x9x12
180	195	9,5	7,5	7	9	12	• PA 180x195x9x12

Other sizes are available on request

• Seal housing dimensions in accordance with ISO 6195-B



## MCW profile data



<b>Material</b>	Metric sizes: TPU U-1029 Inch sizes: TPU U-1023 For additional information → <b>page 26</b>
<b>Speed</b>	Up to 1,5 m/s (4.9 ft/s)
<b>Temperature range</b>	-40 to +120 °C (-40 to +250 °F)
<b>Dimension standards</b>	Some metric sizes fit seal housings in accordance with ISO 6195-B.
<b>Counter-surface</b>	→ <b>page 22</b>

Maximum values of application parameters (e.g. speed, temperature) should not be applied continuously nor simultaneously.

## 4.2 MCW profile wiper seals, metric sizes d 20 – 65 mm

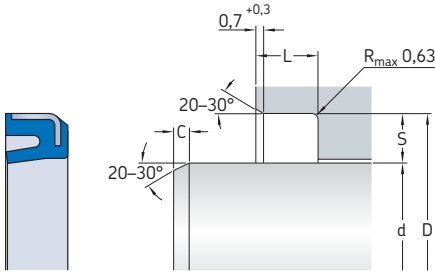

Cylinder dimensions					Designation
d	D	L	S	C	
f7	H8	+0,25		min.	
mm					-
20	30	7	5	5	• MCW-20x30x7-E6Q
25	35	7	5	5	• MCW-25x35x7-E6Q
30	40	7	5	5	• MCW-30x40x7-E6Q
32	42	7	5	5	• MCW-32x42x7-E6Q
35	50	9	7,5	7	MCW-35x50x9-E6Q
36	46	7	5	5	• MCW-36x46x7-E6Q
40	50	7	5	5	• MCW-40x50x7-E6Q
	55	9	7,5	7	MCW-40x55x9-E6Q
45	55	5	5	5	MCW-45x55x5-E6Q
	55	7	5	5	• MCW-45x55x7-E6Q
	60	9	7,5	7	MCW-45x60x9-E6Q
50	60	5	5	5	MCW-50x60x5-E6Q
	60	7	5	5	• MCW-50x60x7-E6Q
	65	9	7,5	7	MCW-50x65x9-E6Q
55	65	5	5	5	MCW-55x65x5-E6Q
56	66	7	5	5	• MCW-56x66x7-E6Q
	68	7	6	5	MCW-56x68x7-E6Q
	71	9	7,5	7	MCW-56x71x9-E6Q
60	70	5	5	5	MCW-60x70x5-E6Q
	74	8	7	7	MCW-60x74x8-E6Q
63	78	9	7,5	7	MCW-63x78x9-E6Q
65	75	5	5	5	MCW-65x75x5-E6Q
	79	8	7	7	MCW-65x79x8-E6Q

• Seal housing dimensions in accordance with ISO 6195-B

## 4.2 MCW profile wiper seals, metric sizes

d 70 – 130 mm

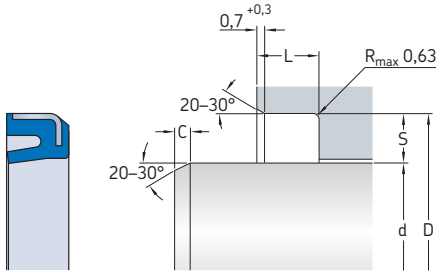

Cylinder dimensions					Designation
d	D	L	S	C	
f7	H8	+0,25		min.	
mm					-
70	80	5	5	5	MCW-70x80x5-E6Q
	80	7	5	5	• MCW-70x80x7-E6Q
	84	8	7	7	MCW-70x84x8-E6Q
	85	7	7,5	7	MCW-70x85x7-E6Q
75	89	8	7	7	MCW-75x89x8-E6Q
	90	7,5	7,5	7	MCW-75x90x7.5-E6Q
80	90	7	5	5	• MCW-80x90x7-E6Q
	94	8	7	7	MCW-80x94x8-E6Q
	100	7	10	7,5	MCW-80x100x7-E6Q
	100	10	10	7,5	MCW-80x100x10-E6Q
85	99	8	7	7	MCW-85x99x8-E6Q
90	104	8	7	7	MCW-90x104x8-E6Q
	105	7	7,5	7	MCW-90x105x7-E6Q
	106	8	8	7	MCW-90x106x8-E6Q
	110	7	10	7,5	MCW-90x110x7-E6Q
95	109	8	7	7	MCW-95x109x8-E6Q
100	110	7	5	5	MCW-100x110x7-E6Q
	114	8	7	7	MCW-100x114x8-E6Q
	116	8	8	7	MCW-100x116x8-E6Q
110	130	8	10	7,5	MCW-110x130x8-E6Q
	130	10	10	7,5	MCW-110x130x10-E6Q
120	136	9	8	7	MCW-120x136x9-E6Q
125	140	9	7,5	7	MCW-125x140x9-E6Q
130	150	10	10	7,5	MCW-130x150x10-E6Q

Other sizes are available on request

• Seal housing dimensions in accordance with ISO 6195-B



## 4.2 MCW profile wiper seals, inch sizes d 0.5 – 2.375 in.

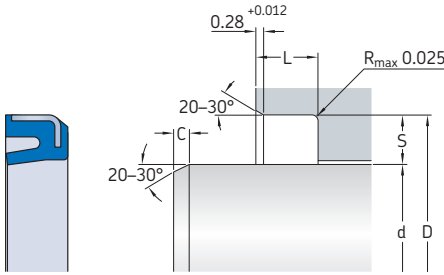

Cylinder dimensions					Designation
d	D	L	S	C	
f7	±0.001	+0.015		min.	
in.					-
0.5	1	0.25	0.25	0.312	MCW-500-H9B
0.625	1.125	0.312	0.25	0.312	MCW-625-H9B
0.75	1.25	0.312	0.25	0.312	MCW-750-H9B
0.875	1.375	0.312	0.25	0.312	MCW-875-H9B
1	1.5	0.312	0.25	0.312	MCW-1000-H9B
1.125	1.625	0.312	0.25	0.312	MCW-1125-H9B
1.187	1.623	0.218	0.25	0.312	MCW218-1187-250-H9B
1.25	1.75	0.312	0.25	0.312	MCW-1250-H9B
1.375	1.875	0.312	0.25	0.312	MCW-1375-H9B
1.5	2	0.312	0.25	0.312	MCW-1500-H9B
	2.125	0.312	0.312	0.312	MCW312-1500-312-H9B
1.562	1.875	0.156	0.375	0.312	MCW156-1562-375-H9B
1.625	2.125	0.312	0.25	0.312	MCW-1625-H9B
1.75	2.25	0.312	0.25	0.312	MCW-1750-H9B
	2.5	0.375	0.375	0.312	MCW375-1750-375-H9B
1.875	2.375	0.312	0.25	0.312	MCW-1875-H9B
2	2.5	0.312	0.25	0.312	MCW-2000-H9B
	2.75	0.375	0.375	0.312	MCW375-2000-375-H9B
	2.875	0.438	0.25	0.312	MCW438-2000-250-H9B
2.125	2.625	0.312	0.25	0.312	MCW-2125-H9B
	2.875	0.375	0.375	0.312	MCW375-2125-375-H9B
2.25	2.75	0.312	0.25	0.312	MCW-2250-H9B
	3	0.375	0.25	0.312	MCW375-2250-250-H9B
2.375	2.875	0.312	0.25	0.312	MCW-2375-H9B

## 4.2 MCW profile wiper seals, inch sizes d 2.5 – 8.5 in.

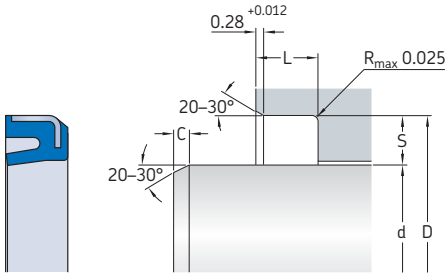

Cylinder dimensions					Designation
d	D	L	S	C	
f7	±0.001	+0.015		min.	
in.					–
2.5	3	0.312	0.25	0.312	MCW-2500-H9B
	3.19	0.345	0.375	0.312	MCW345-2500-375-H9B
2.625	3.125	0.312	0.25	0.312	MCW-2625-H9B
	3.375	0.375	0.375	0.312	MCW375-2625-375-H9B
2.75	3.25	0.312	0.25	0.312	MCW-2750-H9B
	3.5	0.375	0.375	0.312	MCW375-2750-375-H9B
3	3.5	0.312	0.25	0.312	MCW-3000-H9B
	3.75	0.375	0.375	0.312	MCW375-3000-375-H9B
3.125	3.75	0.312	0.312	0.312	MCW-3125-H9B
3.25	3.875	0.312	0.312	0.312	MCW-3250-H9B
3.5	4.125	0.312	0.312	0.312	MCW-3500-H9B
	4.25	0.375	0.312	0.312	MCW375-3500-312-H9B
3.625	4.25	0.312	0.312	0.312	MCW-3625-H9B
3.75	4.375	0.312	0.312	0.312	MCW-3750-H9B
4	4.625	0.312	0.312	0.312	MCW-4000-H9B
4.25	4.875	0.312	0.312	0.312	MCW-4250-H9B
4.5	5.125	0.312	0.312	0.312	MCW-4500-H9B
5	5.625	0.312	0.312	0.312	MCW-5000-H9B
5.5	6.125	0.375	0.312	0.312	MCW-5500-H9B
	6.25	0.375	0.312	0.312	MCW375-5500-312-H9B
5.75	6.375	0.375	0.312	0.312	MCW-5750-H9B
	6.75	0.5	0.5	0.375	MCW500-5750-500-H9B
6	6.625	0.375	0.312	0.312	MCW-6000-H9B
6.5	7.125	0.312	0.312	0.312	MCW312-6500-312-H9B

Cylinder dimensions					Designation
d	D	L	S	C	
f7	±0.001	+0.015		min.	
in.					-
<b>6.75</b>	7.375	0.312	0.312	0.312	<b>MCW312-6750-312-H9B</b>
	7.375	0.375	0.312	0.312	<b>MCW-6750-H9B</b>
<b>7</b>	7.75	0.375	0.312	0.312	<b>MCW375-7000-312-H9B</b>
<b>8</b>	8.75	0.375	0.375	0.312	<b>MCW375-8000-375-H9B</b>
<b>8.5</b>	9.125	0.375	0.312	0.312	<b>MCW-8500-H9B</b>

Other sizes are available on request

### 4.3 PAD and PADV profiles

## PAD and PADV profile data

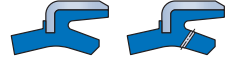

<b>Material</b>	TPU W93 For additional information → <b>page 26</b>
<b>Speed</b>	Up to 1 m/s (3.2 ft/s)
<b>Temperature range</b>	-40 to +110 °C (-40 to +230 °F)
<b>Counter-surface</b>	→ <b>page 22</b>

Maximum values of application parameters (e.g. speed, temperature) should not be applied continuously nor simultaneously.

## 4.3 PAD and PADV profile wiper seals, metric sizes d 35 – 120 mm

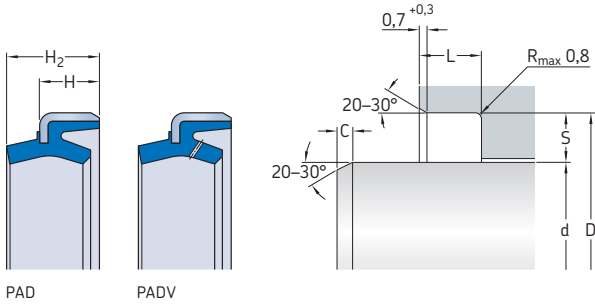

Cylinder dimensions					Seal dimensions		Designations	
d	D	L	S	C	H	H <sub>2</sub>	PAD	PADV (with vent)
f7	H8	±0,25		min.		+1		
mm					mm		-	
35	47	7,5	6	4	7	10	PAD 35x47x7x10	PADV 35x47x7x10
40	52	7,5	6	4	7	10	PAD 40x52x7x10	PADV 40x52x7x10
45	57	7,5	6	4	7	10	PAD 45x57x7x10	PADV 45x57x7x10
50	62	7,5	6	4	7	10	PAD 50x62x7x10	PADV 50x62x7x10
55	69	8,5	7	5	8	11	PAD 55x69x8x11	PADV 55x69x8x11
60	74	8,5	7	5	8	11	PAD 60x74x8x11	PADV 60x74x8x11
65	79	8,5	7	5	8	11	PAD 65x79x8x11	PADV 65x79x8x11
70	84	8,5	7	5	8	11	PAD 70x84x8x11	PADV 70x84x8x11
75	89	8,5	7	5	8	11	PAD 75x89x8x11	PADV 75x89x8x11
80	94	8,5	7	5	8	11	PAD 80x94x8x11	PADV 80x94x8x11
85	99	8,5	7	5	8	11	PAD 85x99x8x11	PADV 85x99x8x11
90	104	8,5	7	5	8	11	PAD 90x104x8x11	PADV 90x104x8x11
95	109	8,5	7	5	8	11	PAD 95x109x8x11	PADV 95x109x8x11
100	114	8,5	7	5	8	11	PAD 100x114x8x11	PADV 100x114x8x11
105	121	9,5	8	7	9	12	PAD 105x121x9x12	PADV 105x121x9x12
110	126	9,5	8	7	9	12	PAD 110x126x9x12	PADV 110x126x9x12
115	131	9,5	8	7	9	12	PAD 115x131x9x12	PADV 115x131x9x12
120	136	9,5	8	7	9	12	PAD 120x136x9x12	PADV 120x136x9x12

Other sizes are available on request

## 4.4 DTW profile

### DTW profile data



<b>Material</b>	TPU U-1003 For additional information → <b>page 26</b>
<b>Speed</b>	Up to 0,75 m/s (2.4 ft/s)
<b>Temperature range</b>	-40 to +120 °C (-40 to +250 °F)
<b>Counter-surface</b>	→ <b>page 22</b>

Maximum values of application parameters (e.g. speed, temperature) should not be applied continuously nor simultaneously.

## 4.4 DTW profile wiper seals, metric sizes

d 18 – 75 mm

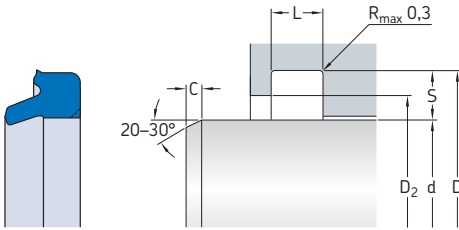

Cylinder dimensions						Designation
d	D	L	D <sub>2</sub>	S	C	
f7	H9	+0,25	+0,25		min.	
mm						-
18	26	5	22	4	4,5	DTW-18x26x5-J2G
20	28	5	24	4	4,5	DTW-20x28x5-J2G
25	33	5	29	4	4,5	DTW-25x33x5-J2G
28	36	5	32	4	4,5	DTW-28x36x5-J2G
30	38	6	34	4	4,5	DTW-30x38x6-J2G
32	40	5	36	4	4,5	DTW-32x40x5-J2G
	40	6	36	4	4,5	DTW-32x40x6-J2G
35	43	6	39	4	4,5	DTW-35x43x6-J2G
40	48	5	44	4	4,5	DTW-40x48x5-J2G
	48	6	44	4	4,5	DTW-40x48x6-J2G
45	53	6	49	4	4,5	DTW-45x53x6-J2G
50	58	5	54	4	4,5	DTW-50x58x5-J2G
	58	6	54	4	4,5	DTW-50x58x6-J2G
55	63	6	59	4	4,5	DTW-55x63x6-J2G
	65	7	60	5	5	DTW-55x65x7-J2G
56	64	6	60	4	4,5	DTW-56x64x6-J2G
60	68	6	64	4	4,5	DTW-60x68x6-J2G
	70	7	65	5	5	DTW-60x70x7-J2G
63	71	6	67	4	4,5	DTW-63x71x6-J2G
65	73	6	69	4	4,5	DTW-65x73x6-J2G
	75	7	70	5	5	DTW-65x75x7-J2G
70	80	7	75	5	5	DTW-70x80x7-J2G
71	81	7	76	5	5	DTW-71x81x7-J2G
75	85	7	80	5	5	DTW-75x85x7-J2G

## 4.4 DTW profile wiper seals, metric sizes

d 80 – 230 mm

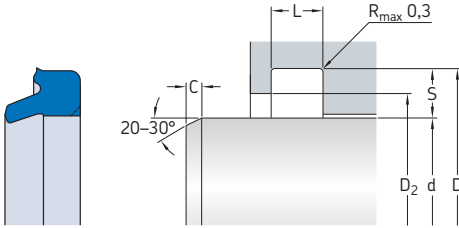

Cylinder dimensions						Designation
d	D	L	D <sub>2</sub>	S	C	
f7	H9	+0,25	+0,25		min.	
mm						-
80	90	7	85	5	5	DTW-80x90x7-J2G
85	95	7	90	5	5	DTW-85x95x7-J2G
90	100	7	95	5	5	DTW-90x100x7-J2G
95	105	7	100	5	5	DTW-95x105x7-J2G
100	110	7	105	5	5	DTW-100x110x7-J2G
105	115	7	110	5	5	DTW-105x115x7-J2G
110	120	7	115	5	5	DTW-110x120x7-J2G
112	122	7	117	5	5	DTW-112x122x7-J2G
115	125	7	120	5	5	DTW-115x125x7-J2G
120	130	7	125	5	5	DTW-120x130x7-J2G
125	138	8	132	6,5	5,5	DTW-125x138x8-J2G
130	143	8	137	6,5	5,5	DTW-130x143x8-J2G
140	153	8	147	6,5	5,5	DTW-140x153x8-J2G
145	158	8	152	6,5	5,5	DTW-145x158x8-J2G
150	163	8	157	6,5	5,5	DTW-150x163x8-J2G
160	173	8	167	6,5	5,5	DTW-160x173x8-J2G
160	174	8	167	7	6	DTW-160x174x8-J2G
170	183	8	177	6,5	5,5	DTW-170x183x8-J2G
170	184	8	177	7	6	DTW-170x184x8-J2G
180	194	8	187	7	6	DTW-180x194x8-J2G



Cylinder dimensions

Designation

d  
f7      D  
H9      L  
+0,25      D<sub>2</sub>  
+0,25      S      C  
min.

mm

-

200	213	8	207	6,5	5,5	DTW-200x213x8-J2G
	214	8	207	7	6	DTW-200x214x8-J2G
230	244	8	237	7	6	DTW-230x244x8-J2G

Other sizes are available on request

## 4.4 DTW profile wiper seals, inch sizes

d 0.25 – 7 in.

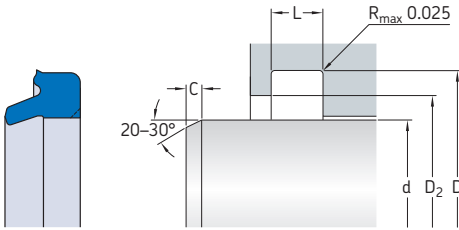

Cylinder dimensions					Designation
d	D	L	D <sub>2</sub>	C	
f7	+0.006	+0.004	+0.010	min.	
in.					-
0.25	0.497	0.124	0.41	0.125	DTW-250-J2G
0.312	0.56	0.124	0.475	0.125	DTW-312-J2G
0.375	0.622	0.124	0.535	0.125	DTW-375-J2G
0.437	0.685	0.124	0.6	0.125	DTW-437-J2G
0.5	0.747	0.124	0.66	0.125	DTW-500-J2G
0.562	0.81	0.124	0.725	0.125	DTW-562-J2G
0.625	0.872	0.124	0.785	0.125	DTW-625-J2G
0.75	1.122	0.187	0.995	0.187	DTW-750-J2G
0.812	1.185	0.187	1.06	0.187	DTW-812-J2G
0.875	1.247	0.187	1.12	0.187	DTW-875-J2G
0.937	1.31	0.187	1.185	0.187	DTW-937-J2G
1	1.372	0.187	1.245	0.187	DTW-1000-J2G
1.125	1.497	0.187	1.37	0.187	DTW-1125-J2G
1.187	1.559	0.187	1.435	0.187	DTW-1187-J2G
1.25	1.622	0.187	1.495	0.187	DTW-1250-J2G
1.312	1.684	0.187	1.56	0.187	DTW-1312-J2G
1.375	1.747	0.187	1.62	0.187	DTW-1375-J2G
1.5	1.872	0.187	1.745	0.187	DTW-1500-J2G
1.562	1.935	0.187	1.81	0.187	DTW-1562-J2G
1.625	1.997	0.187	1.87	0.187	DTW-1625-J2G
1.75	2.122	0.187	1.995	0.187	DTW-1750-J2G

Cylinder dimensions					Designation
d f7	D +0.006	L +0.004	D <sub>2</sub> +0.010	C min.	
in.					-
1.875	2.247	0.187	2.12	0.187	DTW-1875-J2G
1.937	2.31	0.187	2.185	0.187	DTW-1937-J2G
2	2.497	0.249	2.327	0.25	DTW-2000-J2G
2.125	2.622	0.249	2.452	0.25	DTW-2125-J2G
2.25	2.747	0.249	2.577	0.25	DTW-2250-J2G
2.375	2.872	0.249	2.702	0.25	DTW-2375-J2G
2.5	2.997	0.249	2.827	0.25	DTW-2500-J2G
2.625	3.122	0.249	2.952	0.25	DTW-2625-J2G
2.75	3.247	0.249	3.077	0.25	DTW-2750-J2G
2.875	3.372	0.249	3.202	0.25	DTW-2875-J2G
3	3.497	0.249	3.327	0.25	DTW-3000-J2G
3.125	3.622	0.249	3.452	0.25	DTW-3125-J2G
3.25	3.747	0.249	3.577	0.25	DTW-3250-J2G
3.375	3.872	0.249	3.702	0.25	DTW-3375-J2G
3.5	3.997	0.249	3.827	0.25	DTW-3500-J2G
3.625	4.122	0.249	3.952	0.25	DTW-3625-J2G
3.75	4.247	0.249	4.077	0.25	DTW-3750-J2G
3.875	4.372	0.249	4.202	0.25	DTW-3875-J2G
4	4.497	0.249	4.327	0.25	DTW-4000-J2G
4.125	4.622	0.249	4.452	0.25	DTW-4125-J2G
4.25	4.747	0.249	4.577	0.25	DTW-4250-J2G
4.375	4.872	0.249	4.702	0.25	DTW-4375-J2G
4.5	5.247	0.374	4.993	0.375	DTW-4500-J2G
4.75	5.497	0.374	5.243	0.375	DTW-4750-J2G
4.875	5.622	0.374	5.368	0.375	DTW-4875-J2G
5	5.747	0.374	5.493	0.375	DTW-5000-J2G
5.25	5.997	0.374	5.743	0.375	DTW-5250-J2G
5.5	6.247	0.374	5.993	0.375	DTW-5500-J2G
5.75	6.497	0.374	6.243	0.375	DTW-5750-J2G
6	6.747	0.374	6.493	0.375	DTW-6000-J2G
6.25	6.997	0.374	6.743	0.375	DTW-6250-J2G
6.5	7.247	0.374	6.993	0.375	DTW-6500-J2G
6.75	7.497	0.374	7.243	0.375	DTW-6750-J2G
7	7.747	0.374	7.493	0.375	DTW-7000-J2G

## 4.4 DTW profile wiper seals, inch sizes

d 7.25 – 15.75 in.

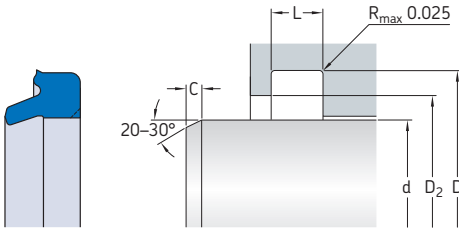

Cylinder dimensions					Designation
d	D	L	D <sub>2</sub>	C	
f7	+0.006	+0.004	+0.010	min.	
in.					-
7.25	7.997	0.374	7.743	0.375	DTW-7250-J2G
7.5	8.247	0.374	7.993	0.375	DTW-7500-J2G
7.75	8.497	0.374	8.243	0.375	DTW-7750-J2G
8	8.747	0.374	8.493	0.375	DTW-8000-J2G
8.25	8.997	0.374	8.743	0.375	DTW-8250-J2G
8.5	9.247	0.374	8.993	0.375	DTW-8500-J2G
8.75	9.497	0.374	9.243	0.375	DTW-8750-J2G
9	9.747	0.374	9.493	0.375	DTW-9000-J2G
9.5	10.247	0.374	9.993	0.375	DTW-9500-J2G
9.75	10.497	0.374	10.243	0.375	DTW-9750-J2G
10	10.997	0.499	10.659	0.5	DTW-10000-J2G
10.5	11.497	0.499	11.159	0.5	DTW-10500-J2G
11	11.997	0.499	11.659	0.5	DTW-11000-J2G
11.5	12.497	0.499	12.159	0.5	DTW-11500-J2G
12.5	13.497	0.499	13.159	0.5	DTW-12500-J2G
15.75	16.747	0.499	16.409	0.5	DTW-15750-J2G

Other sizes are available on request



### DX profile data



<b>Material</b>	Wiper lip: TPU U-1003 or U-1004 O-ring: NBR N70 For additional information → <b>page 26</b>
<b>Speed</b>	Up to 1 m/s (3.2 ft/s)
<b>Temperature range</b>	-40 to +120 °C (-40 to +250 °F)
<b>Counter-surface</b>	→ <b>page 22</b>

Maximum values of application parameters (e.g. speed, temperature) should not be applied continuously nor simultaneously.

## 4.5 DX profile wiper seals, inch sizes

d 0.75 – 4.5 in.

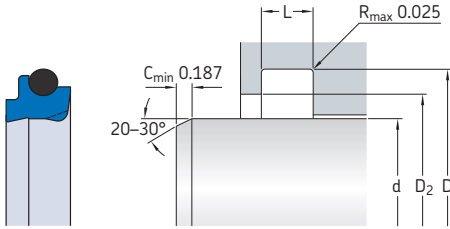

Cylinder dimensions				Designation
d	D	L	D <sub>2</sub>	
f7	+0.006	+0.004	+0.010	
in.				-
0.75	1.122	0.187	0.995	DX-750-J1S
1	1.372	0.187	1.245	DX-1000-J1S
1.125	1.497	0.187	1.37	DX-1125-J1S
1.25	1.622	0.187	1.495	DX-1250-J1S
1.375	1.747	0.187	1.62	DX-1375-J1S
1.5	1.872	0.187	1.745	DX-1500-J1S
1.625	1.997	0.187	1.87	DX-1625-J1S
1.75	2.122	0.187	1.995	DX-1750-J1S
2	2.497	0.249	2.327	DX-2000-J1S
2.25	2.747	0.249	2.577	DX-2250-J1S
2.5	2.997	0.249	2.827	DX-2500-J1S
2.75	3.247	0.249	3.077	DX-2750-J1S
3	3.497	0.249	3.327	DX-3000-J1S
3.125	3.622	0.249	3.452	DX-3125-J1S
3.25	3.747	0.249	3.577	DX-3250-J2X
3.375	3.872	0.249	3.702	DX-3375-J2X
3.5	3.997	0.249	3.827	DX-3500-J2X
3.75	4.247	0.249	4.077	DX-3750-J2X
4	4.497	0.249	4.327	DX-4000-J2X
4.25	4.747	0.249	4.577	DX-4250-J2X
4.5	5.247	0.374	4.993	DX-4500-J2X

## 4.5 DX profile wiper seals, inch sizes d 4.625 – 9 in.

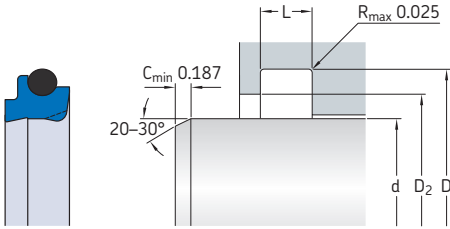

Cylinder dimensions				Designation
d	D	L	D <sub>2</sub>	
f7	+0.006	+0.004	+0.010	
in.				-
4.625	5.372	0.374	5.118	DX-4625-J2X
4.75	5.497	0.374	5.243	DX-4750-J2X
5	5.747	0.374	5.493	DX-5000-J2X
5.5	6.247	0.374	5.993	DX-5500-J2X
5.75	6.497	0.374	6.243	DX-5750-J2X
6	6.747	0.374	6.493	DX-6000-J2X
6.5	7.247	0.374	6.993	DX-6500-J2X
7	7.747	0.374	7.493	DX-7000-J2X
7.25	7.997	0.374	7.743	DX-7250-J2X
8	8.747	0.374	8.493	DX-8000-J2X
8.5	9.247	0.374	8.993	DX-8500-J2X
9	9.747	0.374	9.493	DX-9000-J2X

Other sizes are available on request





## HW profile data



<b>Material</b>	TPU U-1003 For additional information → <b>page 26</b>
<b>Speed</b>	Up to 0,75 m/s (2.4 ft/s)
<b>Temperature range</b>	-40 to +100 °C (-40 to +210 °F)
<b>Counter-surface</b>	→ <b>page 22</b>

Maximum values of application parameters (e.g. speed, temperature) should not be applied continuously nor simultaneously.

## 4.6 HW profile wiper seals, metric sizes

d 14 – 70 mm

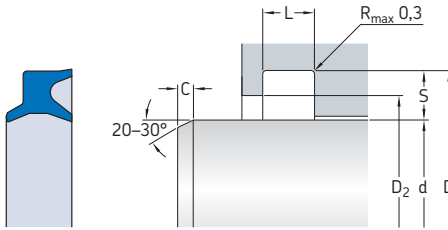

Cylinder dimensions						Designation
d	D	L	D <sub>2</sub>	S	C	
f7	H9	+0,25	+0,25		min.	
mm						-
14	22	5	18	4	3,5	HW-14x22x5-J2G
16	24	5	20	4	3,5	HW-16x24x5-J2G
18	26	5	22	4	3,5	HW-18x26x5-J2G
20	28	5	24	4	3,5	HW-20x28x5-J2G
22	30	5	26	4	3,5	HW-22x30x5-J2G
25	33	5	29	4	3,5	HW-25x33x5-J2G
28	36	5	32	4	3,5	HW-28x36x5-J2G
30	38	6	34	4	3,5	HW-30x38x6-J2G
32	40	6	36	4	3,5	HW-32x40x6-J2G
35	43	6	39	4	3,5	HW-35x43x6-J2G
36	44	6	40	4	3,5	HW-36x44x6-J2G
40	48	6	44	4	3,5	HW-40x48x6-J2G
45	53	6	49	4	3,5	HW-45x53x6-J2G
50	58	6	54	4	3,5	HW-50x58x6-J2G
55	63	6	59	4	3,5	HW-55x63x6-J2G
56	64	6	60	4	3,5	HW-56x64x6-J2G
60	68	6	64	4	3,5	HW-60x68x6-J2G
63	71	6	67	4	3,5	HW-63x71x6-J2G
65	73	6	69	4	3,5	HW-65x73x6-J2G
67	75	6	71	4	3,5	HW-67x75x6-J2G
70	80	7	75	5	3,5	HW-70x80x7-J2G

## 4.6 HW profile wiper seals, metric sizes

d 75 – 140 mm

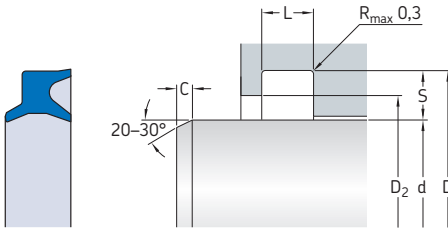

Cylinder dimensions						Designation
d	D	L	D <sub>2</sub>	S	C	
f7	H9	+0,25	+0,25		min.	
mm						-
75	85	7	80	5	3,5	HW-75x85x7-J2G
80	90	7	85	5	3,5	HW-80x90x7-J2G
85	95	7	90	5	3,5	HW-85x95x7-J2G
90	100	7	95	5	3,5	HW-90x100x7-J2G
95	105	7	100	5	3,5	HW-95x105x7-J2G
98	108	7	103	5	3,5	HW-98x108x7-J2G
100	110	7	105	5	3,5	HW-100x110x7-J2G
105	115	7	110	5	3,5	HW-105x115x7-J2G
112	122	7	117	5	3,5	HW-112x122x7-J2G
125	138	8	132	6,5	4,5	HW-125x138x8-J2G
140	153	8	147	6,5	4,5	HW-140x153x8-J2G

Other sizes are available on request

## 4.6 HW profile wiper seals, inch sizes

d 0.25 – 3.5 in.

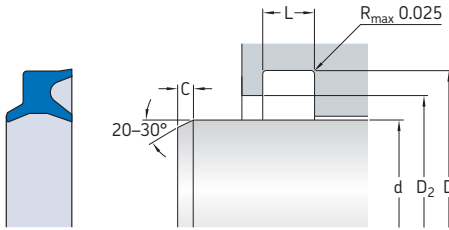

Cylinder dimensions					Designation
d	D	L	D <sub>2</sub>	C	
f7	+0.003	+0.015	+0.003	min.	
in.					-
0.25	0.552	0.203	0.37	0.187	HW-0250-J2G
0.5	0.802	0.203	0.62	0.187	HW-0500-J2G
0.625	0.927	0.203	0.745	0.187	HW-0625-J2G
0.75	1.052	0.203	0.87	0.187	HW-0750-J2G
0.937	1.302	0.218	1.072	0.187	HW-0937-J2G
1	1.365	0.218	1.135	0.187	HW-1000-J2G
1.25	1.615	0.218	1.385	0.187	HW-1250-J2G
1.375	1.74	0.218	1.51	0.187	HW-1375-J2G
1.437	1.802	0.218	1.572	0.187	HW-1437-J2G
1.5	1.865	0.218	1.635	0.187	HW-1500-J2G
1.625	1.99	0.218	1.76	0.187	HW-1625-J2G
1.75	2.115	0.218	1.885	0.187	HW-1750-J2G
1.875	2.24	0.218	2.01	0.187	HW-1875-J2G
2	2.365	0.218	2.135	0.187	HW-2000-J2G
2.125	2.49	0.218	2.26	0.187	HW-2125-J2G
2.25	2.745	0.281	2.385	0.25	HW-2250-J2G
2.5	2.995	0.281	2.635	0.25	HW-2500-J2G
2.625	3.12	0.281	2.76	0.25	HW-2625-J2G
3	3.495	0.281	3.135	0.25	HW-3000-J2G
3.25	3.745	0.281	3.385	0.25	HW-3250-J2G
3.5	3.995	0.281	3.635	0.25	HW-3500-J2G

4.6

## 4.6 HW profile wiper seals, inch sizes

d 3.75 – 8 in.

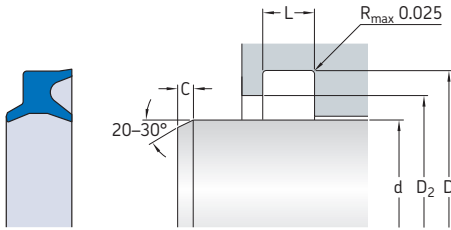

Cylinder dimensions					Designation
d	D	L	D <sub>2</sub>	C	
f7	+0.003	+0.015	+0.003	min.	
in.					-
3.75	4.245	0.281	3.885	0.25	HW-3750-J2G
4	4.495	0.281	4.135	0.25	HW-4000-J2G
4.25	4.745	0.281	4.385	0.25	HW-4250-J2G
4.5	4.995	0.281	4.635	0.25	HW-4500-J2G
4.75	5.245	0.281	4.885	0.25	HW-4750-J2G
5	5.495	0.281	5.135	0.25	HW-5000-J2G
5.125	5.62	0.281	5.26	0.25	HW-5125-J2G
5.25	5.745	0.281	5.385	0.25	HW-5250-J2G
7	7.495	0.281	7.135	0.25	HW-7000-J2G
8	8.495	0.281	8.135	0.25	HW-8000-J2G

Other sizes are available on request



## Wiper seals

### More wiper seals

#### Wiper seals made of PTFE

SKF wiper seals made of PTFE (→ **fig. 12**) are intended for applications where there is a demand for low breakaway friction or chemical resistance. SKF machines PTFE wipers from stock. Therefore, SKF can supply PTFE wipers in a wide variety of profiles and different sizes at short notice.

For additional information about PTFE wiper seals, contact SKF.

#### Rod seals used as wiper seals

STD rod seal profiles (→ *STD profiles*, **page 118**) are designed with similar inside and outside sealing geometry and, therefore, can also be used as aggressive snap-in wiper seals (→ **fig. 13**).

For additional information about rod seals used as wiper seals, contact SKF.

#### Customized machined seal profiles

SKF can manufacture a wide variety of wiper seal profiles (→ **fig. 14**) with different materials and customized sizes with its industry-leading SKF SEAL JET production system. SKF can supply these tailor-made machined wiper seals in close partnership with customers from the design phase to serial production.

For additional information about customized machined profiles, refer to publication *Customized machined seals – Product range* or contact SKF.

Fig. 12

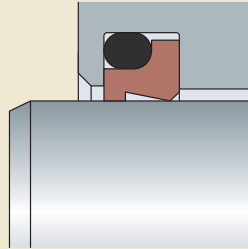

Fig. 13

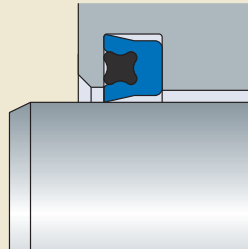



Fig. 14

SKF SEAL JET profile examples



A01-A



A01-B



A02-A



A02-B



A02-I



A03-A



A04-A



A04-B



A05-A



A05-B



A05-I



A06-A



A07-A



A08-B



A09-A



A10-A



A11-A



A11-I



A12-3A



A12-A



A12-B



A13-A



A25-F



A26-F



A27-F

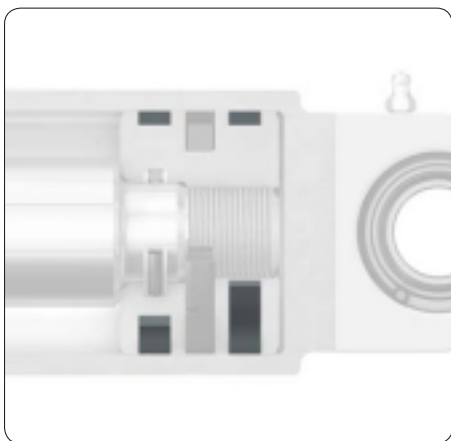
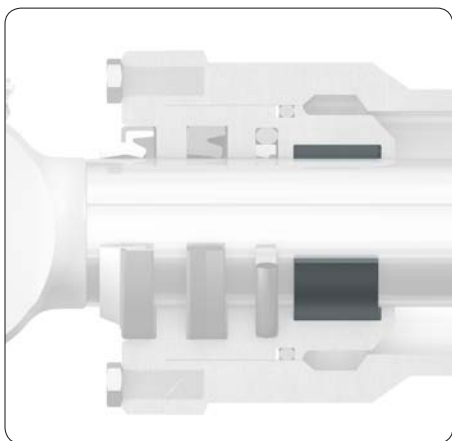
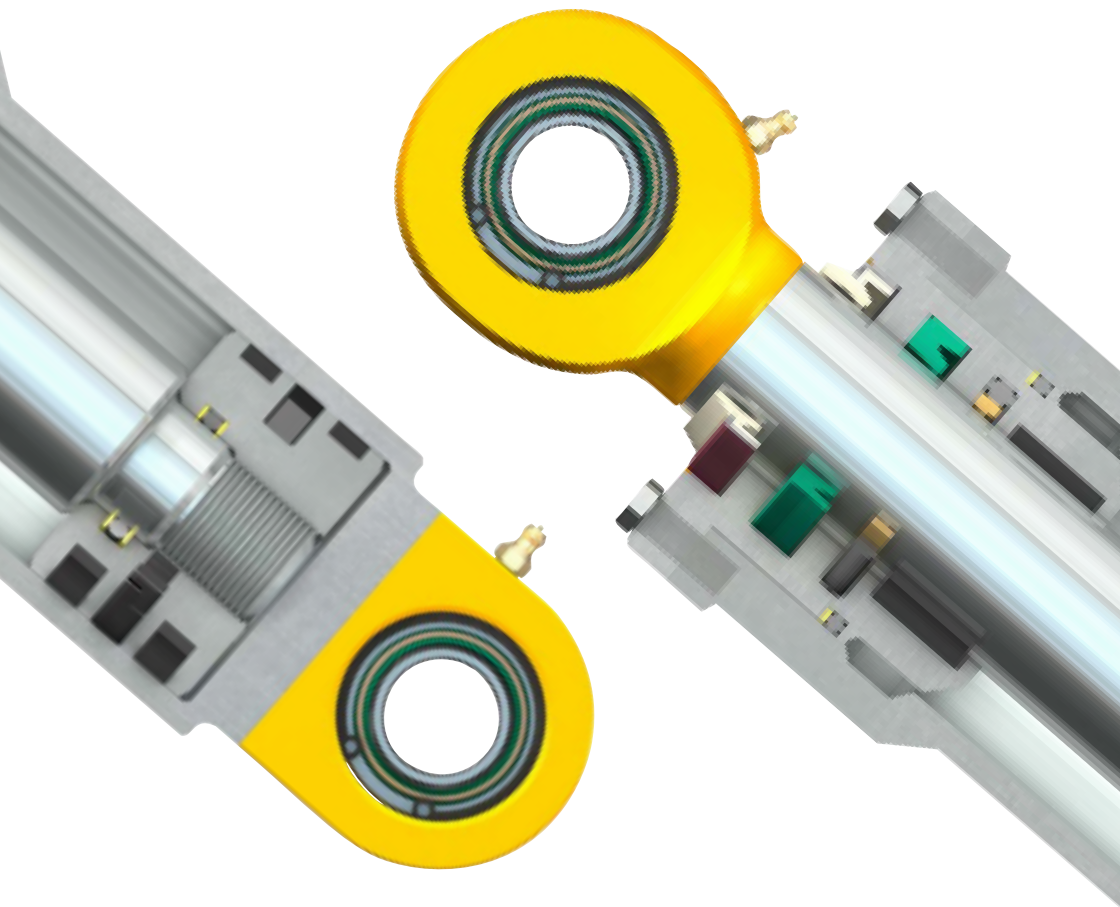

# Guide rings and guide strips

<b>Basics</b> .....	<b>250</b>	<b>Profile data</b>	
Concentric alignment of cylinder components .....	251	<b>5.1</b> WAT rod or piston guide rings, metric sizes .....	260
Guide distance .....	251	<b>5.2</b> WAT rod or piston guide rings, inch sizes .....	266
Guide lubrication .....	251	<b>5.3</b> RGR rod guide rings, metric sizes .....	280
Load distribution and guide width .....	252	<b>5.4</b> PGR piston guide rings, metric sizes .....	284
<b>Materials</b> .....	<b>253</b>	<b>More guide rings</b> .....	<b>288</b>
Polyamide .....	253	Spark rings .....	288
Phenolic/fabric composite .....	253	Customized machined guide profiles .....	288
PTFE .....	253		
<b>Guide rings</b> .....	<b>255</b>		
WAT rod or piston guide rings .....	255		
RGR rod guide rings .....	255		
PGR piston guide rings .....	255		
<b>Guide strips</b> .....	<b>256</b>		
<b>Guide ring width</b> .....	<b>259</b>		

## Basics

Guide rings and guide strips accommodate radial loads of forces acting on the cylinder assembly and guide the rod in the cylinder head as well as the piston in the cylinder bore (→ **fig. 1**).

Guides are made of polymer materials and, therefore, avoid metal-to-metal contact between moving parts in a working hydraulic cylinder. Compared to metal guides, polymer guides provide the following advantages in hydraulic cylinders:

- significantly longer service life
- work more smoothly against the cylinder tube and the sealing surfaces
- avoid wear of cylinder surfaces despite the presence of contamination particles
- high resistance to insufficient lubrication at low speeds
- larger contact area (→ **fig. 2, page 251** and **fig. 4, page 252**) due to higher degree of elastic deformation distributes the load and reduces stress to counter-surface
- certain self-lubricating ability

SKF supplies different precision machined guide rings with different polymer materials and sizes, which make them appropriate for a wide variety of operating conditions and applications.

Guide strips and guide rings of PTFE are also available for applications where static friction must be minimized. PTFE guides have limited load carrying capability and should only be used in applications with light loads.

### More information

Counter-surface finish properties . . . . .	22
Materials . . . . .	26
Hydraulic fluids . . . . .	31
Storage . . . . .	36

Fig. 1

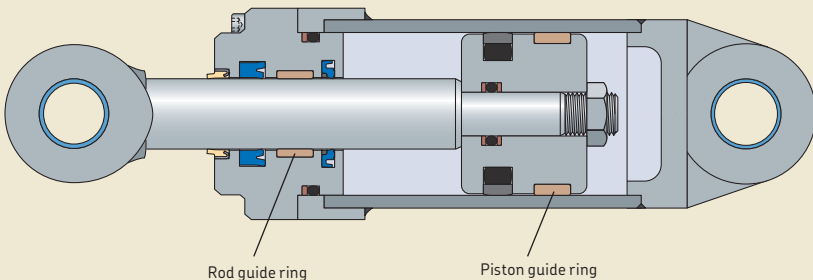

## Concentric alignment of cylinder components

Significantly, cylinders and all their components are designed to minimize radial movements at load or pressure changes. It is also important that the piston and rod remain in a concentric position during the entire stroke to maintain seal effectiveness, especially at low temperatures, and to minimize the buckling loads on the piston rod. This in turn depends on the combined tolerances of the cylinder bore, the rod, the radial thickness of the guide rings or strips, and the housing diameters.

## Guide distance

The bending moment on the cylinder components and the load on guide rings at any point in the cylinder stroke are a function of the radial loads and the distance between the rod and piston guides. Therefore, the distance between guide rings should be considered when designing the cylinder and calculating the guide ring loads.

## Guide lubrication

The guide must receive ample lubrication at all times. Rod guide rings are typically placed inward of both the rod and buffer seal and should be lubricated on assembly with the same oil as the system media. SKF recommends not to place guide rings outside the rod seal. However, in certain conditions, PTFE guides or strips may be used outside the rod seal due to their self-lubricating properties.

Fig. 2

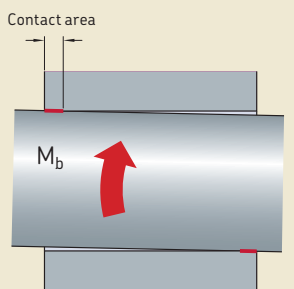

Metal guide

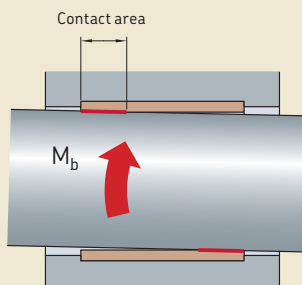

Polymer guide

## Guide rings and guide strips

### Load distribution and guide width

With metal guides, the machining tolerance would cause a diameter mismatch, resulting in a narrow contact area and high stress contact ( $\rightarrow$  fig. 3), which could cause damage or wear to the guiding surfaces.

The higher degree of elastic deformation of polymer materials provides larger contact surfaces and a better utilization of the guide width ( $\rightarrow$  fig. 4). While the guide ring load is realistically not an even distribution, the guide

ring load and width requirements of precision tolerance guide rings are estimated with the projected area of the full dynamic surface (inside diameter for rod guides or outside diameter for piston guides) assuming the load is carried evenly across the surface ( $\rightarrow$  fig. 5).

SKF recommends using a safety factor of at least  $f \geq 2$  to double the radial load when calculating the required guide width ( $\rightarrow$  *Guide ring width*, page 259). The effective load carrying width of the guide ring is approx. 2 mm (0.08 in.) smaller than the housing groove width because of the manufacturing and installation tolerances and the reduction of the guide ring width by the chamfers and radii. Dynamic forces, accelerating forces, vibrations and angular forces should be considered when calculating the transverse forces from the rod ends of the cylinders.

For additional information, contact SKF.

Fig.3

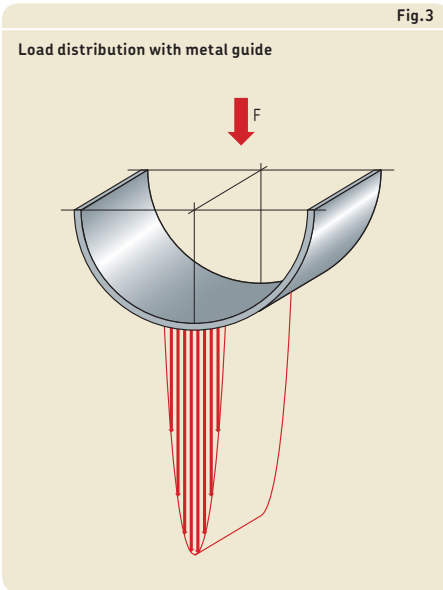

Fig.4

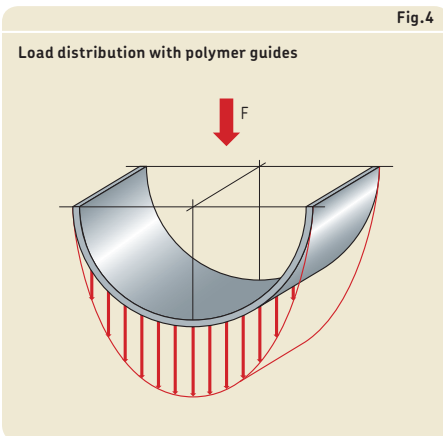
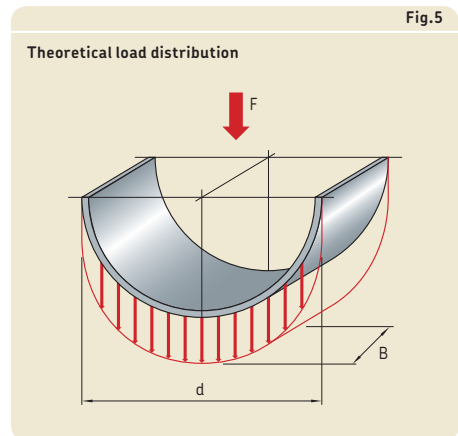

Fig.5



## Materials

The demands on reliability are continuously increasing. At the same time, the service conditions are getting tougher to match the development towards higher effectiveness of the hydraulic systems. Therefore, it is very important to be familiar with the operating conditions and parameters, such as operating temperature and pressure, load, speed, and fluid when choosing the most appropriate guide material. The most common materials for guides listed in this catalogue are:

- glass fibre reinforced polyamide
- phenolic/fabric composite
- PTFE

### Polyamide

Glass fibre reinforced polyamide guides are suitable for medium and heavy duty applications and are characterized by the following properties:

- wide temperature range
- wear resistant
- reduce vibrations
- protect seals from particles
- protect components from diesel effect
- easy to install
- tight tolerances
- withstand heavy side loads
- withstand high cycling speed
- prone to moisture swell before installation

GFR PA P-2501 is the standard polyamide material for guide rings. Technical specifications are provided in **table 1** (→ **page 254**). For additional information, refer to *Materials* (→ **page 26**).

### Phenolic/fabric composite

Phenolic/fabric composite consists of cotton fabric bound with thermoset phenolic resin. Its structure and the ability of the fabric fibres to absorb a certain amount of oil make phenolic guides almost self-lubricating. However, phenolic guides should not be used at high stroke speeds over 0,5 m/s (1.6 ft/s). Phenolic guides are suitable for medium and heavy duty appli-

cations and are characterized by the following properties:

- wide temperature range
- wear resistant
- reduce vibrations
- protect seals from particles
- protect components from diesel effect
- low thermal expansion
- easy to install
- tight tolerances
- withstand heavy side loads

Technical specifications are provided in **table 1** (→ **page 254**). SKF also supplies a variety of other thermosetting resins and fabrics on request.

For additional information, refer to *Materials* (→ **page 26**).

### PTFE

PTFE is typically used in guides where low friction and resistance to chemical, heat or wear are essential. However, PTFE should only be used in applications with low surface pressure. To obtain optimal wear resistance, PTFE materials are available with different fillers, such as bronze or carbon powder. PTFE guides are characterized by the following properties:

- chemical resistance
- wide temperature range
- low friction
- anti-adhesive, low breakaway friction
- good wear resistance
- reduce vibrations
- protect seals from particles
- protect components from diesel effect
- tight tolerance machined guide rings available

PTFE MS-292 is the standard PTFE material for guides and strips. Technical specifications are provided in **table 1** (→ **page 254**). SKF also can supply many other PTFE material compounds on request.

For additional information, refer to *Materials* (→ **page 26**).

Table 1

### Guide ring material comparison

Material	Ultimate compressive strength	Maximum recommended speed <sup>1)</sup>	Maximum recommended application temperature <sup>1)</sup>	Maximum recommended bearing load pressure <sup>1)</sup> at 20 °C (70 °F)	Maximum recommended bearing load pressure <sup>1)</sup> at 80 °C (175 °F)
–	N/mm <sup>2</sup> (psi)	m/s (ft/s)	°C (°F)	N/mm <sup>2</sup> (psi)	N/mm <sup>2</sup> (psi)
<b>Polyamide P-2551</b>	158 (22 915)	1 (3.3)	120 (250)	40 (5 800)	30 (4 350)
<b>Phenolic PF</b>	240 (34 805)	0,5 (1.6)	120 (250)	50 (7 250)	30 (4 350)
<b>PTFE MS-292</b>	<sup>2)</sup> (depending on time and temperature)	5 (16.4) (depending on seal system)	200 (390)	15 (2 175)	7,5 (1 085)

<sup>1)</sup> Maximum values are for intermittent exposure and should not be applied simultaneously.

<sup>2)</sup> PTFE is subject to creep under compression and, therefore, compressive strength depends on time and temperature.



## Guide rings

SKF guide rings are precision machined according to tight tolerance specifications on the radial section of the guide. Therefore, they optimize guide load distribution and limit radial misalignment of components for best seal performance. SKF supplies the following guide rings:

- WAT rod or piston guide rings
- RGR rod guide rings
- PGR piston guide rings

All of these precision guide rings are split with an angle cut as standard (→ **fig. 8, page 257**). Other types and designs or angles of cut are available on request.

### WAT rod or piston guide rings

These standard guide rings can be used in piston or rod applications, means either dynamic on the outside or inside surfaces. WAT guide rings are made of glass fibre reinforced polyamide (GFR PA P-2501) as standard. On request, SKF can supply WAT guide rings in a variety of materials, including self-lubricated rings with PTFE (P-2551).

### RGR rod guide rings

RGR guide rings are developed for guiding rods with dynamic inside surfaces. They are made of phenolic/fabric composite (PF) as standard. On request, SKF can supply RGR guide rings in a variety of materials.

They are manufactured and packaged to promote an open split before mounting and, therefore, clamp in the inside groove of the cylinder head. This makes it easier to assemble the cylinder later.

### PGR piston guide rings

PGR guide rings are developed for guiding pistons with dynamic outside surface. They are made of phenolic/fabric composite (PF) as standard. On request, SKF can supply RGR guide rings in a variety of materials.

They are manufactured and packaged to promote a narrow split or even closed ring before mounting and, therefore, be tight in the external groove in the piston. This makes it easier to assemble the cylinder later.

## Guide rings and guide strips

### Guide strips

SKF guide strips are made of PTFE and should only be used in light duty applications or when fluid, temperature, friction, or speed do not allow any other material. They are typically used with PTFE sealing systems (→ **fig. 6**). At system operating pressures over 200 bar (2 900 psi), contact SKF.

PTFE guide strips are available with different designs (→ **fig. 7**) and can be cut with different configurations (→ **fig. 8**).

### Guide strips cut to length

Based on the hardware dimensions, SKF can supply guide strips with specified lengths. They are designated according to a system that states the type and design, dynamic diameter, groove diameter, groove width, type of cut and material (→ **table 2**).

For additional information and order assistance, contact SKF.

Fig. 6

#### PTFE sealing system

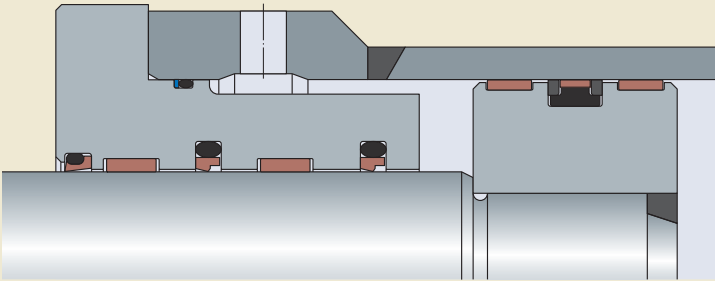

Fig. 7

#### Guide strips surface treatments



Type SB with a basic design



Type SB/C with four chamfered edges

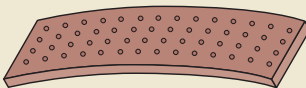

Type SBC with a coined surface



Type SBE etched on both sides

Fig. 8

Guide strips cut configurations

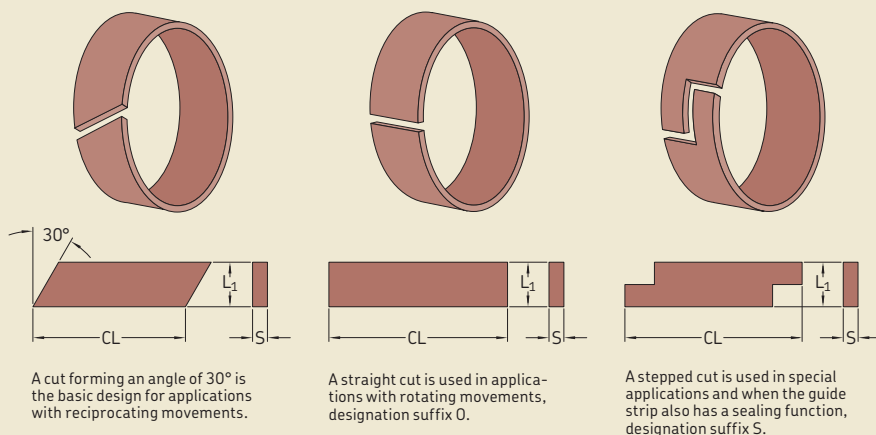

5

Table 2

Designation system for guide strips with individual length



## Guide rings and guide strips

### Guide strips uncut

SKF can also supply uncut guide strips. They are designated by the type and design, thickness and groove width in millimetres, material code, and length in metres, such as SB 2x8,1-292 / 25 m.

For additional information and order assistance, contact SKF.

### Calculating the guide strip length

The individual guide strip length CL can be calculated using the formulas provided in **table 3**.

Table 3

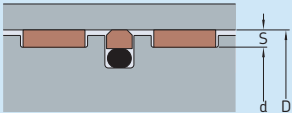
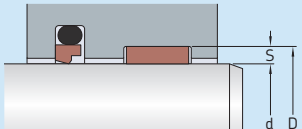
Guide strip length CL		
Material	Guide strip for piston applications	Guide strip for rod applications
		
PTFE, material code MS-292	$CL = 3,11 (D - S) - 0,8$	$CL = 3,11 (d + S) - 0,8$
PTFE, material codes MS-302, MS-304	$CL = 3,116 (D - S) - 0,8$	$CL = 3,116 (d + S) - 0,8$
	CL = guide strip length [mm] D = cylinder bore diameter [mm] d = rod diameter [mm] S = strip thickness [mm]	

## Guide ring width

The requisite minimum guide ring width can be calculated for:

- piston guide ring width using

$$L = \frac{F f}{p D} + 2$$

- rod guide ring width using

$$L = \frac{F f}{p d} + 2$$

where

L = requisite minimum guide ring housing width [mm]

D = cylinder bore diameter [mm]

d = rod diameter [mm]

F = radial load [N]

f = safety factor (recommended minimum 2 for calculations using max. load pressure p)

p = maximum recommended bearing load pressure [N/mm<sup>2</sup>] (→ **table 1, page 254**)

### Example

A phenolic/fabric composite piston guide ring (type PGR .. PF), 3 mm thick, is required for a piston diameter D = 100 mm. The load F = 20 000 N and the safety factor f = 2. What is the required guide ring width L at an operating temperature of 80 °C?

From **table 1** (→ **page 254**), the maximum recommended bearing load pressure p = 30 N/mm<sup>2</sup>. The required guide ring width L is

$$L = \frac{20\,000 \times 2}{30 \times 100} + 2 = 15,3 \text{ mm}$$

The required guide ring width L is 15,3 mm, however, choose a guide ring with L = 20 mm, which is the nearest larger guide ring width, such as PGR 100x94x20-PF (→ **product table, page 285**).

## 5.1 WAT rod or piston guide rings, metric sizes

D 28 – 86 mm

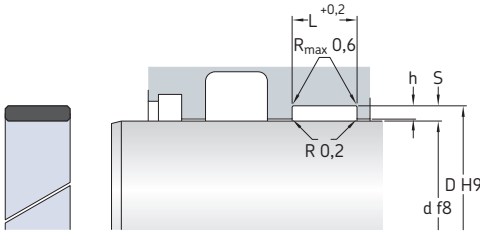

Rod application  
(dynamic on the inside surface)

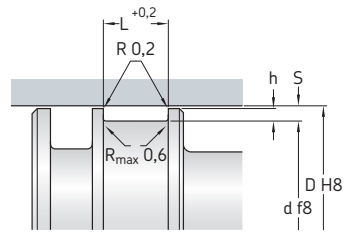

Piston application  
(dynamic on the outside surface)

$h \geq S/2$

Cylinder dimensions				Designation
D	d	L	S	
mm				-
28	25	5,6	1,5	WAT-25x28x5.6-E8D
28,1	25	4	1,55	WAT-25x28.1x4-E8D
30	25	5,6	2,5	WAT-25x30x5.6-E8D
	25	9,7	2,5	WAT-25x30x9.7-E8D
	26	8	2	WAT-26x30x8-E8D
	27	5,6	1,5	WAT-27x30x5.6-E8D
31	27	8	2	WAT-27x31x8-E8D
	28	5,6	1,5	WAT-28x31x5.6-E8D
31,1	28	4	1,55	WAT-28x31.1x4-E8D
32	27	5,6	2,5	WAT-27x32x5.6-E8D
	28	8	2	WAT-28x32x8-E8D
	28,9	4	1,55	WAT-28.9x32x4-E8D
	29	5,6	1,5	WAT-29x32x5.6-E8D
33	28	5,6	2,5	WAT-28x33x5.6-E8D
	29	10	2	WAT-29x33x10-E8D
	30	5,6	1,5	WAT-30x33x5.6-E8D
35	30	15,3	2,5	WAT-30x35x15.3-E8D
	31	8	2	WAT-31x35x8-E8D
	31	10	2	WAT-31x35x10-E8D
	32	5,6	1,5	WAT-32x35x5.6-E8D
36	33	5,6	1,5	WAT-33x36x5.6-E8D
	37	5,6	2,5	WAT-32x37x5.6-E8D
37	32	5,6	2,5	WAT-32x37x5.6-E8D
	32	9,7	2,5	WAT-32x37x9.7-E8D
	32	15	2,5	WAT-32x37x15-E8D
38	34	10	2	WAT-34x38x10-E8D
	35	5,6	1,5	WAT-35x38x5.6-E8D
39	36	5,6	1,5	WAT-36x39x5.6-E8D

Cylinder dimensions				Designation
D	d	L	S	
mm				-
40	35	5,6	2,5	WAT-35x40x5.6-E8D
	35	10	2,5	WAT-35x40x10-E8D
	35	15	2,5	WAT-35x40x15-E8D
36	36	8	2	WAT-36x40x8-E8D
	36	10	2	WAT-36x40x10-E8D
	36,9	4	1,55	WAT-36.9x40x4-E8D
	37	5,6	1,5	WAT-37x40x5.6-E8D
	37	5,6	1,5	WAT-37x40x5.6-E8D
41	36	5,6	2,5	WAT-36x41x5.6-E8D
	36	9,7	2,5	WAT-36x41x9.7-E8D
	37	15	2	WAT-37x41x15-E8D
	37	15,3	2	WAT-37x41x15.3-E8D
38	5,6	1,5	WAT-38x41x5.6-E8D	
42	37	5,6	2,5	WAT-37x42x5.6-E8D
43	38	15	2,5	WAT-38x43x15-E8D
	38	15,3	2,5	WAT-38x43x15.3-E8D
	40	5,6	1,5	WAT-40x43x5.6-E8D
45	40	5,6	2,5	WAT-40x45x5.6-E8D
	40	8	2,5	WAT-40x45x8-E8D
	40	9,7	2,5	WAT-40x45x9.7-E8D
	40	15	2,5	WAT-40x45x15-E8D
	40	20	2,5	WAT-40x45x20-E8D
47	42	5,6	2,5	WAT-42x47x5.6-E8D
	42	15	2,5	WAT-42x47x15-E8D
50	44	10	3	WAT-44x50x10-E8D
	45	5,6	2,5	WAT-45x50x5.6-E8D
	45	8	2,5	WAT-45x50x8-E8D
	45	9,7	2,5	WAT-45x50x9.7-E8D
	45	15	2,5	WAT-45x50x15-E8D
45	15,3	2,5	WAT-45x50x15.3-E8D	
46,9	4	1,55	WAT-46.9x50x4-E8D	

Cylinder dimensions				Designation	
D	d	L	S		
mm				-	
55	50	5,6	2,5	WAT-50x55x5,6-E8D	
	50	5,8	2,5	WAT-50x55x5,8-E8D	
	50	8	2,5	WAT-50x55x8-E8D	
	50	9,7	2,5	WAT-50x55x9,7-E8D	
	50	15	2,5	WAT-50x55x15-E8D	
	50	15,3	2,5	WAT-50x55x15,3-E8D	
56	51	5,6	2,5	WAT-51x56x5,6-E8D	
	51	8	2,5	WAT-51x56x8-E8D	
	51	15	2,5	WAT-51x56x15-E8D	
	51	15,3	2,5	WAT-51x56x15,3-E8D	
60	54	13	3	WAT-54x60x13-E8D	
	55	5,6	2,5	WAT-55x60x5,6-E8D	
	55	8	2,5	WAT-55x60x8-E8D	
	55	9,7	2,5	WAT-55x60x9,7-E8D	
	55	10	2,5	WAT-55x60x10-E8D	
	55	13	2,5	WAT-55x60x13-E8D	
	55	15	2,5	WAT-55x60x15-E8D	
	55	15,3	2,5	WAT-55x60x15,3-E8D	
	61	50	5,6	5,5	WAT-50x61x5,6-E8D
		50	9,7	5,5	WAT-50x61x9,7-E8D
56		5,6	2,5	WAT-56x61x5,6-E8D	
56		9,7	2,5	WAT-56x61x9,7-E8D	
56		15	2,5	WAT-56x61x15-E8D	
63		58	5,6	2,5	WAT-58x63x5,6-E8D
	58	8	2,5	WAT-58x63x8-E8D	
	58	9,7	2,5	WAT-58x63x9,7-E8D	
	58	15	2,5	WAT-58x63x15-E8D	
65	59	13	3	WAT-59x65x13-E8D	
	60	5,6	2,5	WAT-60x65x5,6-E8D	
	60	9,7	2,5	WAT-60x65x9,7-E8D	
	60	10	2,5	WAT-60x65x10-E8D	
	60	15	2,5	WAT-60x65x15-E8D	
	60	15,3	2,5	WAT-60x65x15,3-E8D	
	60	20	2,5	WAT-60x65x20-E8D	
	60	20,3	2,5	WAT-60x65x20,3-E8D	
	60	25	2,5	WAT-60x65x25-E8D	
	66	60	10	3	WAT-60x66x10-E8D
60		13	3	WAT-60x66x13-E8D	
61		20	2,5	WAT-61x66x20-E8D	
61		20,3	2,5	WAT-61x66x20,3-E8D	
68	63	5,6	2,5	WAT-63x68x5,6-E8D	
	63	9,7	2,5	WAT-63x68x9,7-E8D	
	63	10	2,5	WAT-63x68x10-E8D	
	63	13	2,5	WAT-63x68x13-E8D	
	63	15	2,5	WAT-63x68x15-E8D	
	63	20	2,5	WAT-63x68x20-E8D	
69	64	10	2,5	WAT-64x69x10-E8D	
	64	20	2,5	WAT-64x69x20-E8D	
	64	20,3	2,5	WAT-64x69x20,3-E8D	

Cylinder dimensions				Designation
D	d	L	S	
mm				-
70	62	25	4	WAT-62x70x25-E8D
	64	13	3	WAT-64x70x13-E8D
65	65	9,7	2,5	WAT-65x70x9,7-E8D
	65	10	2,5	WAT-65x70x10-E8D
	65	13	2,5	WAT-65x70x13-E8D
	65	15	2,5	WAT-65x70x15-E8D
	65	20	2,5	WAT-65x70x20-E8D
	65	20,3	2,5	WAT-65x70x20,3-E8D
	71	66	10	2,5
66		20	2,5	WAT-66x71x20-E8D
73	68	10	2,5	WAT-68x73x10-E8D
	68	13	2,5	WAT-68x73x13-E8D
75	69	10	3	WAT-69x75x10-E8D
	69	13	3	WAT-69x75x13-E8D
70	70	5,6	2,5	WAT-70x75x5,6-E8D
	70	9,7	2,5	WAT-70x75x9,7-E8D
	70	10	2,5	WAT-70x75x10-E8D
	70	13	2,5	WAT-70x75x13-E8D
70	70	15	2,5	WAT-70x75x15-E8D
	70	20	2,5	WAT-70x75x20-E8D
	70	20,3	2,5	WAT-70x75x20,3-E8D
	76	70	13	3
70		15,3	3	WAT-70x76x15,3-E8D
70		19,5	3	WAT-70x76x19,5-E8D
71		20	2,5	WAT-71x76x20-E8D
80	74	20,3	3	WAT-74x80x20,3-E8D
	74	25,5	3	WAT-74x80x25,5-E8D
75	75	5,6	2,5	WAT-75x80x5,6-E8D
	75	9,7	2,5	WAT-75x80x9,7-E8D
	75	10	2,5	WAT-75x80x10-E8D
	75	15	2,5	WAT-75x80x15-E8D
	75	20	2,5	WAT-75x80x20-E8D
75	75	20,3	2,5	WAT-75x80x20,3-E8D
	75	30,5	2,5	WAT-75x80x30,5-E8D
	85	79	13	3
79		15	3	WAT-79x85x15-E8D
79		25	3	WAT-79x85x25-E8D
80	80	9,7	2,5	WAT-80x85x9,7-E8D
	80	13	2,5	WAT-80x85x13-E8D
	80	15	2,5	WAT-80x85x15-E8D
	80	20	2,5	WAT-80x85x20-E8D
	80	25	2,5	WAT-80x85x25-E8D
86	80	13	3	WAT-80x86x13-E8D
	80	19,5	3	WAT-80x86x19,5-E8D



## 5.1 WAT rod or piston guide rings, metric sizes

D 90 – 165 mm

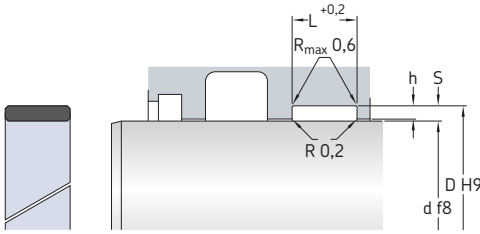

Rod application  
(dynamic on the inside surface)

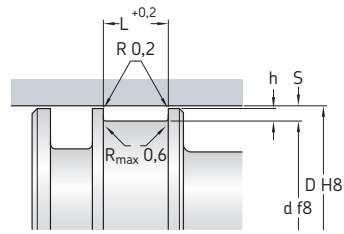

Piston application  
(dynamic on the outside surface)

$h \geq S/2$

Cylinder dimensions					Designation	Cylinder dimensions					Designation
D	d	L	S			D	d	L	S		
mm					-	mm					-
90	84	13	3		WAT-84x90x13-E8D	101	95	13	3		WAT-95x101x13-E8D
	84	15	3		WAT-84x90x15-E8D		95	19,5	3		WAT-95x101x19.5-E8D
	84	15,3	3		WAT-84x90x15.3-E8D	105	99	10	3		WAT-99x105x10-E8D
	84	25	3		WAT-84x90x25-E8D		99	25	3		WAT-99x105x25-E8D
	84	25,5	3		WAT-84x90x25.5-E8D		100	9,7	2,5		WAT-100x105x9.7-E8D
							100	15	2,5		WAT-100x105x15-E8D
					100	25	2,5		WAT-100x105x25-E8D		
					100	30,5	2,5		WAT-100x105x30.5-E8D		
93	85	9,7	2,5		WAT-85x90x9.7-E8D	107	101	15	3		WAT-101x107x15-E8D
	85	10	2,5		WAT-85x90x10-E8D		110	102	15	4	
	85	15	2,5		WAT-85x90x15-E8D	102		25	4		WAT-102x110x25-E8D
85	30	2,5		WAT-85x90x30-E8D	104	13		3		WAT-104x110x13-E8D	
95	88	10	2,5		WAT-88x93x10-E8D	104		15	3		WAT-104x110x15-E8D
	88	13	2,5		WAT-88x93x13-E8D	104		25	3		WAT-104x110x25-E8D
96	89	13	3		WAT-89x95x13-E8D	104		25,5	3		WAT-104x110x25.5-E8D
	89	15	3		WAT-89x95x15-E8D	105	105	8	2,5		WAT-105x110x8-E8D
	90	9,7	2,5		WAT-90x95x9.7-E8D		105	9,7	2,5		WAT-105x110x9.7-E8D
	90	10	2,5		WAT-90x95x10-E8D		105	13	2,5		WAT-105x110x13-E8D
	90	13	2,5		WAT-90x95x13-E8D		105	15	2,5		WAT-105x110x15-E8D
	90	15	2,5		WAT-90x95x15-E8D		112	106	15	3	
90	20	2,5		WAT-90x95x20-E8D	106	30		3		WAT-106x112x30-E8D	
96	90	10	3		WAT-90x96x10-E8D	107		10	2,5		WAT-107x112x10-E8D
	90	13	3		WAT-90x96x13-E8D	107	13	2,5		WAT-107x112x13-E8D	
	90	19,5	3		WAT-90x96x19.5-E8D	115	107	13	4		WAT-107x115x13-E8D
100	94	15	3		WAT-94x100x15-E8D		109	19,5	3		WAT-109x115x19.5-E8D
	94	15,3	3		WAT-94x100x15.3-E8D		109	30	3		WAT-109x115x30-E8D
	94	25	3		WAT-94x100x25-E8D	110	110	9,7	2,5		WAT-110x115x9.7-E8D
	94	25,5	3		WAT-94x100x25.5-E8D		110	15	2,5		WAT-110x115x15-E8D
	94	30,5	3		WAT-94x100x30.5-E8D		110	20	2,5		WAT-110x115x20-E8D
							110	25	2,5		WAT-110x115x25-E8D
					110		30	2,5		WAT-110x115x30-E8D	
					110		30	2,5		WAT-110x115x30-E8D	
100	95	5,6	2,5		WAT-95x100x5.6-E8D	116	110	9,7	3		WAT-110x116x9.7-E8D
	95	9,7	2,5		WAT-95x100x9.7-E8D		110	25,5	3		WAT-110x116x25.5-E8D
	95	10	2,5		WAT-95x100x10-E8D						
	95	13	2,5		WAT-95x100x13-E8D						
	95	15	2,5		WAT-95x100x15-E8D						
	95	15,3	2,5		WAT-95x100x15.3-E8D						



Cylinder dimensions				Designation	
D	d	L	S		
mm				-	
120	112	25	4	WAT-112x120x25-E8D	
	114	13	3	WAT-114x120x13-E8D	
	114	15	3	WAT-114x120x15-E8D	
	114	15,3	3	WAT-114x120x15.3-E8D	
	114	20	3	WAT-114x120x20-E8D	
	114	30	3	WAT-114x120x30-E8D	
	114	30,5	3	WAT-114x120x30.5-E8D	
	115	9,7	2,5	WAT-115x120x9.7-E8D	
	115	13	2,5	WAT-115x120x13-E8D	
	115	15	2,5	WAT-115x120x15-E8D	
	115	25	2,5	WAT-115x120x25-E8D	
	121	115	20,3	3	WAT-115x121x20.3-E8D
		115	30,5	3	WAT-115x121x30.5-E8D
	125	117	25	4	WAT-117x125x25-E8D
119		15	3	WAT-119x125x15-E8D	
119		19,5	3	WAT-119x125x19.5-E8D	
119		25,5	3	WAT-119x125x25.5-E8D	
119		30	3	WAT-119x125x30-E8D	
119		30,5	3	WAT-119x125x30.5-E8D	
120		5,6	2,5	WAT-120x125x5.6-E8D	
120		8	2,5	WAT-120x125x8-E8D	
120		9,7	2,5	WAT-120x125x9.7-E8D	
120		15	2,5	WAT-120x125x15-E8D	
126	120	20	2,5	WAT-120x125x20-E8D	
	120	25	2,5	WAT-120x125x25-E8D	
	120	10	3	WAT-120x126x10-E8D	
	120	15,3	3	WAT-120x126x15.3-E8D	
	120	20,3	3	WAT-120x126x20.3-E8D	
	130	123	15	3,5	WAT-123x130x15-E8D
123		30	3,5	WAT-123x130x30-E8D	
124		10	3	WAT-124x130x10-E8D	
124		13	3	WAT-124x130x13-E8D	
124		30,5	3	WAT-124x130x30.5-E8D	
125		8	2,5	WAT-125x130x8-E8D	
125		9,7	2,5	WAT-125x130x9.7-E8D	
125		15	2,5	WAT-125x130x15-E8D	
125		15,3	2,5	WAT-125x130x15.3-E8D	
125		25,5	2,5	WAT-125x130x25.5-E8D	
135		129	19,5	3	WAT-129x135x19.5-E8D
		130	9,7	2,5	WAT-130x135x9.7-E8D
	130	15	2,5	WAT-130x135x15-E8D	
	130	20	2,5	WAT-130x135x20-E8D	
	130	30	2,5	WAT-130x135x30-E8D	
136	130	9,7	3	WAT-130x136x9.7-E8D	
	130	15,3	3	WAT-130x136x15.3-E8D	
	130	25,5	3	WAT-130x136x25.5-E8D	

Cylinder dimensions				Designation
D	d	L	S	
mm				-
140	132	20	4	WAT-132x140x20-E8D
	132	25	4	WAT-132x140x25-E8D
	133	20	3,5	WAT-133x140x20-E8D
134	134	13	3	WAT-134x140x13-E8D
	134	15,3	3	WAT-134x140x15.3-E8D
	134	20,3	3	WAT-134x140x20.3-E8D
	134	25,5	3	WAT-134x140x25.5-E8D
	135	9,7	2,5	WAT-135x140x9.7-E8D
	135	13	2,5	WAT-135x140x13-E8D
135	135	15	2,5	WAT-135x140x15-E8D
	135	15,3	2,5	WAT-135x140x15.3-E8D
	135	20	2,5	WAT-135x140x20-E8D
	139	13	3	WAT-139x145x13-E8D
	139	19,5	3	WAT-139x145x19.5-E8D
	139	30,5	3	WAT-139x145x30.5-E8D
140	140	9,7	2,5	WAT-140x145x9.7-E8D
	140	15	2,5	WAT-140x145x15-E8D
	140	20	2,5	WAT-140x145x20-E8D
	140	25	2,5	WAT-140x145x25-E8D
	140	30	2,5	WAT-140x145x30-E8D
	140	30,5	2,5	WAT-140x145x30.5-E8D
146	140	13	3	WAT-140x146x13-E8D
	140	15,3	3	WAT-140x146x15.3-E8D
150	142	20	4	WAT-142x150x20-E8D
	142	25	4	WAT-142x150x25-E8D
	143	20	3,5	WAT-143x150x20-E8D
	144	13	3	WAT-144x150x13-E8D
	144	25,5	3	WAT-144x150x25.5-E8D
145	145	9,7	2,5	WAT-145x150x9.7-E8D
	145	13	2,5	WAT-145x150x13-E8D
	145	15	2,5	WAT-145x150x15-E8D
	145	20	2,5	WAT-145x150x20-E8D
	145	25	2,5	WAT-145x150x25-E8D
	150	15	2,5	WAT-150x155x15-E8D
155	150	20	2,5	WAT-150x155x20-E8D
	150	30,5	2,5	WAT-150x155x30.5-E8D
	150	40	3,5	WAT-150x157x40-E8D
160	152	15,3	4	WAT-152x160x15.3-E8D
	152	25	4	WAT-152x160x25-E8D
	153	20	3,5	WAT-153x160x20-E8D
	153	40	3,5	WAT-153x160x40-E8D
	154	19,5	3	WAT-154x160x19.5-E8D
	154	25,5	3	WAT-154x160x25.5-E8D
	155	9,7	2,5	WAT-155x160x9.7-E8D
	155	15	2,5	WAT-155x160x15-E8D
155	155	15,3	2,5	WAT-155x160x15.3-E8D
	155	20	2,5	WAT-155x160x20-E8D
	155	25	2,5	WAT-155x160x25-E8D
	155	25,5	2,5	WAT-155x160x25.5-E8D
	157	45	4	WAT-157x165x45-E8D
	159	19,5	3	WAT-159x165x19.5-E8D
160	160	9,7	2,5	WAT-160x165x9.7-E8D
	160	15	2,5	WAT-160x165x15-E8D
	160	30,5	2,5	WAT-160x165x30.5-E8D
	160	30,5	2,5	WAT-160x165x30.5-E8D

5.1

## 5.1 WAT rod or piston guide rings, metric sizes

D 170 – 260 mm

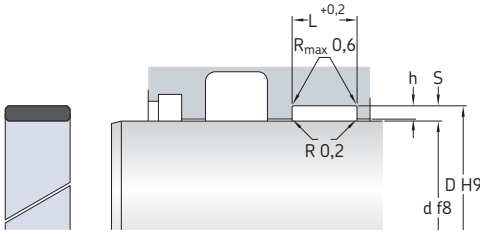

Rod application  
(dynamic on the inside surface)

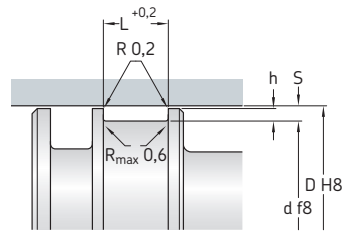

Piston application  
(dynamic on the outside surface)

$h \geq S/2$

Cylinder dimensions					Designation	Cylinder dimensions					Designation	
D	d	L	S			D	d	L	S			
mm					-	mm					-	
170	162	15	4		WAT-162x170x15-E8D	190	182	25	4		WAT-182x190x25-E8D	
	162	25	4		WAT-162x170x25-E8D		182	45	4		WAT-182x190x45-E8D	
	162	45	4		WAT-162x170x45-E8D		184	15	3		WAT-184x190x15-E8D	
	164	9,7	3		WAT-164x170x9.7-E8D		185	15,3	2,5		WAT-185x190x15.3-E8D	
	164	25,5	3		WAT-164x170x25.5-E8D		185	25,5	2,5		WAT-185x190x25.5-E8D	
	165	9,7	2,5		WAT-165x170x9.7-E8D		195	190	15	2,5		WAT-190x195x15-E8D
	165	15	2,5		WAT-165x170x15-E8D			190	25	2,5		WAT-190x195x25-E8D
	165	15,3	2,5		WAT-165x170x15.3-E8D		200	192	25	4		WAT-192x200x25-E8D
	165	20	2,5		WAT-165x170x20-E8D			192	45	4		WAT-192x200x45-E8D
	165	20,3	2,5		WAT-165x170x20.3-E8D			194	15,3	3		WAT-194x200x15.3-E8D
170	15	2,5		WAT-170x175x15-E8D	194	20,3		3		WAT-194x200x20.3-E8D		
175	170	25	2,5		WAT-170x175x25-E8D	195	195	9,7	2,5		WAT-195x200x9.7-E8D	
	170	30,5	2,5		WAT-170x175x30.5-E8D		195	15	2,5		WAT-195x200x15-E8D	
180	172	15	4		WAT-172x180x15-E8D		195	15,3	2,5		WAT-195x200x15.3-E8D	
	172	20	4		WAT-172x180x20-E8D		195	20	2,5		WAT-195x200x20-E8D	
	172	25	4		WAT-172x180x25-E8D		195	25	2,5		WAT-195x200x25-E8D	
	172	45	4		WAT-172x180x45-E8D		195	25,5	2,5		WAT-195x200x25.5-E8D	
	174	19,5	3		WAT-174x180x19.5-E8D	204	196	25	4		WAT-196x204x25-E8D	
185	175	9,7	2,5		WAT-175x180x9.7-E8D	205	197	50	4		WAT-197x205x50-E8D	
	175	15	2,5		WAT-175x180x15-E8D		200	15	2,5		WAT-200x205x15-E8D	
	175	15,3	2,5		WAT-175x180x15.3-E8D		200	25	2,5		WAT-200x205x25-E8D	
	175	20,3	2,5		WAT-175x180x20.3-E8D	208	200	25	4		WAT-200x208x25-E8D	
	177	45	4		WAT-177x185x45-E8D		202	25	4		WAT-202x210x25-E8D	
	179	9,7	3		WAT-179x185x9.7-E8D		202	50	4		WAT-202x210x50-E8D	
186	180	9,7	2,5		WAT-180x185x9.7-E8D	210	205	15	2,5		WAT-205x210x15-E8D	
	180	15	2,5		WAT-180x185x15-E8D		202	25	3		WAT-209x215x25.5-E8D	
	180	25,5	2,5		WAT-180x185x25.5-E8D	210	15	2,5		WAT-210x215x15-E8D		
	186	180	15,3	3		WAT-180x186x15.3-E8D	210	20,3	2,5		WAT-210x215x20.3-E8D	
188	180	25	4		WAT-180x188x25-E8D	218	210	25	4		WAT-210x218x25-E8D	

Cylinder dimensions				Designation
D	d	L	S	
mm				-
220	212	50	4	WAT-212x220x50-E8D
	215	9,7	2,5	WAT-215x220x9.7-E8D
	215	15	2,5	WAT-215x220x15-E8D
	215	15,3	2,5	WAT-215x220x15.3-E8D
224	216	25	4	WAT-216x224x25-E8D
	216	50	4	WAT-216x224x50-E8D
225	217	25	4	WAT-217x225x25-E8D
	217	50	4	WAT-217x225x50-E8D
	219	15,3	3	WAT-219x225x15.3-E8D
	220	15	2,5	WAT-220x225x15-E8D
	220	25	2,5	WAT-220x225x25-E8D
230	222	20	4	WAT-222x230x20-E8D
	222	30	4	WAT-222x230x30-E8D
	222	55	4	WAT-222x230x55-E8D
	225	20,3	2,5	WAT-225x230x20.3-E8D
235	229	25,5	3	WAT-229x235x25.5-E8D
240	232	30	4	WAT-232x240x30-E8D
	232	55	4	WAT-232x240x55-E8D
	235	20,3	2,5	WAT-235x240x20.3-E8D
	235	25,5	2,5	WAT-235x240x25.5-E8D
250	242	20,3	4	WAT-242x250x20.3-E8D
	242	30	4	WAT-242x250x30-E8D
	242	55	4	WAT-242x250x55-E8D
	244	15,3	3	WAT-244x250x15.3-E8D
	245	9,7	2,5	WAT-245x250x9.7-E8D
	245	15	2,5	WAT-245x250x15-E8D
255	250	15	2,5	WAT-250x255x15-E8D
	250	25	2,5	WAT-250x255x25-E8D
260	252	20,3	4	WAT-252x260x20.3-E8D
	252	30,5	4	WAT-252x260x30.5-E8D

5.1

## 5.2 WAT rod or piston guide rings, inch sizes

D 1 – 2.5 in.

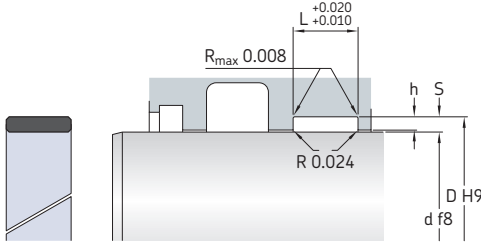

Rod application  
(dynamic on the inside surface)

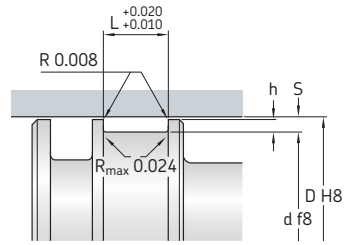

Piston application  
(dynamic on the outside surface)

$h \geq S/2$

Cylinder dimensions				Designation	Cylinder dimensions				Designation	
D	d	L	S		D	d	L	S		
in.				-	in.				-	
1	0.813	0.25	0.093	WAT93-1000-250-E8D	1.25	1.125	0.312	0.062	WAT62-1250-312-E8D	
	0.813	0.312	0.093	WAT93-1000-312-E8D		cont.	1.125	0.375	0.062	WAT62-1250-375-E8D
	0.813	0.375	0.093	WAT93-1000-375-E8D		1.125	0.5	0.062	WAT62-1250-500-E8D	
	0.813	0.5	0.093	WAT93-1000-500-E8D		1.125	0.625	0.062	WAT62-1250-625-E8D	
	0.813	0.625	0.093	WAT93-1000-625-E8D		1.125	0.75	0.062	WAT62-1250-750-E8D	
	0.875	0.25	0.062	WAT62-1000-250-E8D		1.5	1.25	0.187	0.125	WAT125-1500-187-E8D
	0.875	0.312	0.062	WAT62-1000-312-E8D			1.25	0.25	0.125	WAT125-1500-250-E8D
	0.875	0.375	0.062	WAT62-1000-375-E8D			1.25	0.312	0.125	WAT125-1500-312-E8D
	0.875	0.5	0.062	WAT62-1000-500-E8D			1.25	0.375	0.125	WAT125-1500-375-E8D
	0.875	0.625	0.062	WAT62-1000-625-E8D			1.25	0.5	0.125	WAT125-1500-500-E8D
1.125	0.938	0.25	0.093	WAT93-1125-250-E8D	1.25	0.625	0.125	WAT125-1500-625-E8D		
	0.938	0.312	0.093	WAT93-1125-312-E8D	1.25	0.75	0.125	WAT125-1500-750-E8D		
	0.938	0.375	0.093	WAT93-1125-375-E8D	1.25	0.875	0.125	WAT125-1500-875-E8D		
	0.938	0.5	0.093	WAT93-1125-500-E8D	1.25	1	0.125	WAT125-1500-1000-E8D		
	0.938	0.625	0.093	WAT93-1125-625-E8D	1.313	0.25	0.093	WAT93-1500-250-E8D		
	1	0.187	0.062	WAT62-1125-187-E8D	1.313	0.312	0.093	WAT93-1500-312-E8D		
	1	0.25	0.062	WAT62-1125-250-E8D	1.313	0.375	0.093	WAT93-1500-375-E8D		
	1	0.312	0.062	WAT62-1125-312-E8D	1.313	0.5	0.093	WAT93-1500-500-E8D		
	1	0.375	0.062	WAT62-1125-375-E8D	1.313	0.625	0.093	WAT93-1500-625-E8D		
	1	0.5	0.062	WAT62-1125-500-E8D	1.313	0.75	0.093	WAT93-1500-750-E8D		
1.25	1	0.625	0.062	WAT62-1125-625-E8D	1.313	0.875	0.093	WAT93-1500-875-E8D		
	1	0.625	0.062	WAT62-1125-625-E8D	1.313	1	0.093	WAT93-1500-1000-E8D		
	1	0.187	0.125	WAT125-1250-187-E8D	1.375	0.187	0.062	WAT62-1500-187-E8D		
	1	0.25	0.125	WAT125-1250-250-E8D	1.375	0.25	0.062	WAT62-1500-250-E8D		
	1	0.312	0.125	WAT125-1250-312-E8D	1.375	0.312	0.062	WAT62-1500-312-E8D		
	1	0.375	0.125	WAT125-1250-375-E8D	1.375	0.375	0.062	WAT62-1500-375-E8D		
	1	0.5	0.125	WAT125-1250-500-E8D	1.375	0.5	0.062	WAT62-1500-500-E8D		
	1	0.625	0.125	WAT125-1250-625-E8D	1.375	0.625	0.062	WAT62-1500-625-E8D		
	1	0.75	0.125	WAT125-1250-750-E8D	1.375	0.75	0.062	WAT62-1500-750-E8D		
	1.063	0.25	0.093	WAT93-1250-250-E8D	1.375	0.875	0.062	WAT62-1500-875-E8D		
1.063	0.312	0.093	WAT93-1250-312-E8D	1.375	1	0.062	WAT62-1500-1000-E8D			
1.063	0.375	0.093	WAT93-1250-375-E8D	1.75	1.5	0.25	0.125	WAT125-1750-250-E8D		
1.063	0.5	0.093	WAT93-1250-500-E8D		1.5	0.312	0.125	WAT125-1750-312-E8D		
1.063	0.625	0.093	WAT93-1250-625-E8D		1.5	0.375	0.125	WAT125-1750-375-E8D		
1.063	0.75	0.093	WAT93-1250-750-E8D		1.5	0.5	0.125	WAT125-1750-500-E8D		
1.125	0.187	0.062	WAT62-1250-187-E8D							
1.125	0.25	0.062	WAT62-1250-250-E8D							

Cylinder dimensions				Designation
D	d	L	S	
in.				-
1.75 cont.	1.5	0.625	0.125	WAT125-1750-625-E8D
	1.5	0.75	0.125	WAT125-1750-750-E8D
	1.5	0.875	0.125	WAT125-1750-875-E8D
	1.5	1	0.125	WAT125-1750-1000-E8D
	1.563	0.25	0.093	WAT93-1750-250-E8D
	1.563	0.312	0.093	WAT93-1750-312-E8D
	1.563	0.375	0.093	WAT93-1750-375-E8D
	1.563	0.5	0.093	WAT93-1750-500-E8D
	1.563	0.625	0.093	WAT93-1750-625-E8D
	1.563	0.75	0.093	WAT93-1750-750-E8D
	1.563	0.875	0.093	WAT93-1750-875-E8D
	1.563	1	0.093	WAT93-1750-1000-E8D
2	1.625	0.25	0.062	WAT62-1750-250-E8D
	1.625	0.312	0.062	WAT62-1750-312-E8D
	1.625	0.375	0.062	WAT62-1750-375-E8D
	1.625	0.5	0.062	WAT62-1750-500-E8D
	1.625	0.625	0.062	WAT62-1750-625-E8D
	1.625	0.75	0.062	WAT62-1750-750-E8D
	1.625	0.875	0.062	WAT62-1750-875-E8D
	1.625	1	0.062	WAT62-1750-1000-E8D
	1.625	0.25	0.187	WAT187-2000-250-E8D
	1.625	0.312	0.187	WAT187-2000-312-E8D
	1.625	0.375	0.187	WAT187-2000-375-E8D
	1.625	0.5	0.187	WAT187-2000-500-E8D
1.625	0.625	0.187	WAT187-2000-625-E8D	
2	1.625	0.75	0.187	WAT187-2000-750-E8D
	1.625	0.875	0.187	WAT187-2000-875-E8D
	1.625	1	0.187	WAT187-2000-1000-E8D
	1.625	1.25	0.187	WAT187-2000-1250-E8D
	1.625	1.5	0.187	WAT187-2000-1500-E8D
	1.75	0.25	0.125	WAT125-2000-250-E8D
	1.75	0.312	0.125	WAT125-2000-312-E8D
	1.75	0.375	0.125	WAT125-2000-375-E8D
	1.75	0.5	0.125	WAT125-2000-500-E8D
	1.75	0.625	0.125	WAT125-2000-625-E8D
	1.75	0.75	0.125	WAT125-2000-750-E8D
	1.75	0.875	0.125	WAT125-2000-875-E8D
1.75	1	0.125	WAT125-2000-1000-E8D	
1.75	1.25	0.125	WAT125-2000-1250-E8D	
1.75	1.5	0.125	WAT125-2000-1500-E8D	
1.813	0.25	0.093	WAT93-2000-250-E8D	
	0.312	0.093	WAT93-2000-312-E8D	
	0.375	0.093	WAT93-2000-375-E8D	
	0.5	0.093	WAT93-2000-500-E8D	
	0.625	0.093	WAT93-2000-625-E8D	
	0.75	0.093	WAT93-2000-750-E8D	
	0.875	0.093	WAT93-2000-875-E8D	
	1	0.093	WAT93-2000-1000-E8D	
	1.25	0.093	WAT93-2000-1250-E8D	
	1.5	0.093	WAT93-2000-1500-E8D	
	1.875	0.25	0.062	WAT62-2000-250-E8D
	1.875	0.312	0.062	WAT62-2000-312-E8D
1.875	0.375	0.062	WAT62-2000-375-E8D	
1.875	0.5	0.062	WAT62-2000-500-E8D	
1.875	0.625	0.062	WAT62-2000-625-E8D	

Cylinder dimensions				Designation
D	d	L	S	
in.				-
2	1.875	0.75	0.062	WAT62-2000-750-E8D
	1.875	0.875	0.062	WAT62-2000-875-E8D
	1.875	1	0.062	WAT62-2000-1000-E8D
	1.875	1.25	0.062	WAT62-2000-1250-E8D
	1.875	1.5	0.062	WAT62-2000-1500-E8D
2.25	1.875	0.25	0.187	WAT187-2250-250-E8D
	1.875	0.312	0.187	WAT187-2250-312-E8D
	1.875	0.375	0.187	WAT187-2250-375-E8D
	1.875	0.5	0.187	WAT187-2250-500-E8D
	1.875	0.625	0.187	WAT187-2250-625-E8D
2	1.875	0.75	0.187	WAT187-2250-750-E8D
	1.875	0.875	0.187	WAT187-2250-875-E8D
	1.875	1	0.187	WAT187-2250-1000-E8D
	1.875	1.25	0.187	WAT187-2250-1250-E8D
	1.875	1.5	0.187	WAT187-2250-1500-E8D
2	2	0.25	0.125	WAT125-2250-250-E8D
	2	0.312	0.125	WAT125-2250-312-E8D
	2	0.375	0.125	WAT125-2250-375-E8D
	2	0.5	0.125	WAT125-2250-500-E8D
	2	0.625	0.125	WAT125-2250-625-E8D
2	2	0.75	0.125	WAT125-2250-750-E8D
	2	0.875	0.125	WAT125-2250-875-E8D
	2	1	0.125	WAT125-2250-1000-E8D
	2	1.25	0.125	WAT125-2250-1250-E8D
	2	1.5	0.125	WAT125-2250-1500-E8D
2.063	0.25	0.093	WAT93-2250-250-E8D	
	0.312	0.093	WAT93-2250-312-E8D	
	0.375	0.093	WAT93-2250-375-E8D	
	0.5	0.093	WAT93-2250-500-E8D	
	0.625	0.093	WAT93-2250-625-E8D	
2.063	0.75	0.093	WAT93-2250-750-E8D	
	0.875	0.093	WAT93-2250-875-E8D	
	1	0.093	WAT93-2250-1000-E8D	
	1.25	0.093	WAT93-2250-1250-E8D	
	1.5	0.093	WAT93-2250-1500-E8D	
2.125	0.25	0.062	WAT62-2250-250-E8D	
	0.312	0.062	WAT62-2250-312-E8D	
	0.375	0.062	WAT62-2250-375-E8D	
	0.5	0.062	WAT62-2250-500-E8D	
	0.625	0.062	WAT62-2250-625-E8D	
2.125	0.75	0.062	WAT62-2250-750-E8D	
	0.875	0.062	WAT62-2250-875-E8D	
	1	0.062	WAT62-2250-1000-E8D	
	1.25	0.062	WAT62-2250-1250-E8D	
	1.5	0.062	WAT62-2250-1500-E8D	
2.5	2.125	0.25	0.187	WAT187-2500-250-E8D
	2.125	0.312	0.187	WAT187-2500-312-E8D
	2.125	0.375	0.187	WAT187-2500-375-E8D
	2.125	0.5	0.187	WAT187-2500-500-E8D
	2.125	0.625	0.187	WAT187-2500-625-E8D
2.125	0.75	0.187	WAT187-2500-750-E8D	
	0.875	0.187	WAT187-2500-875-E8D	
	1	0.187	WAT187-2500-1000-E8D	
	1.25	0.187	WAT187-2500-1250-E8D	
	1.5	0.187	WAT187-2500-1500-E8D	
2.125	1.75	0.187	WAT187-2500-1750-E8D	

5.2

## 5.2 WAT rod or piston guide rings, inch sizes

D 2.5 – 3.25 in.

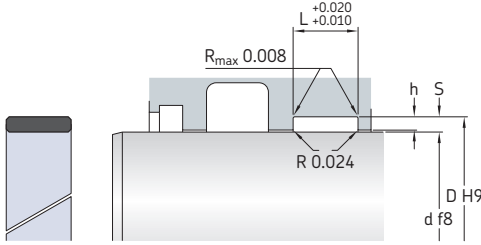

Rod application  
(dynamic on the inside surface)

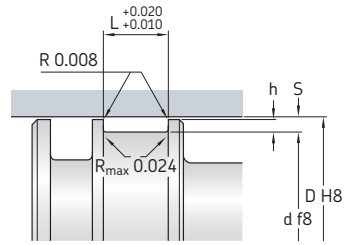

Piston application  
(dynamic on the outside surface)

$h \geq S/2$

Cylinder dimensions				Designation
D	d	L	S	
in.				-
2.5 cont.	2.25	0.25	0.125	WAT125-2500-250-E8D
	2.25	0.312	0.125	WAT125-2500-312-E8D
	2.25	0.375	0.125	WAT125-2500-375-E8D
	2.25	0.5	0.125	WAT125-2500-500-E8D
	2.25	0.625	0.125	WAT125-2500-625-E8D
	2.25	0.75	0.125	WAT125-2500-750-E8D
	2.25	0.875	0.125	WAT125-2500-875-E8D
	2.25	1	0.125	WAT125-2500-1000-E8D
	2.25	1.25	0.125	WAT125-2500-1250-E8D
	2.25	1.5	0.125	WAT125-2500-1500-E8D
	2.25	1.75	0.125	WAT125-2500-1750-E8D
	2.313	0.25	0.093	WAT93-2500-250-E8D
	2.313	0.312	0.093	WAT93-2500-312-E8D
	2.313	0.375	0.093	WAT93-2500-375-E8D
	2.313	0.5	0.093	WAT93-2500-500-E8D
	2.313	0.625	0.093	WAT93-2500-625-E8D
	2.313	0.75	0.093	WAT93-2500-750-E8D
	2.313	0.875	0.093	WAT93-2500-875-E8D
	2.313	1	0.093	WAT93-2500-1000-E8D
	2.313	1.25	0.093	WAT93-2500-1250-E8D
	2.313	1.5	0.093	WAT93-2500-1500-E8D
	2.313	1.75	0.093	WAT93-2500-1750-E8D
	2.375	0.25	0.062	WAT62-2500-250-E8D
	2.375	0.312	0.062	WAT62-2500-312-E8D
2.375	0.375	0.062	WAT62-2500-375-E8D	
2.375	0.5	0.062	WAT62-2500-500-E8D	
2.375	0.625	0.062	WAT62-2500-625-E8D	
2.375	0.75	0.062	WAT62-2500-750-E8D	
2.375	0.875	0.062	WAT62-2500-875-E8D	
2.375	1	0.062	WAT62-2500-1000-E8D	
2.375	1.25	0.062	WAT62-2500-1250-E8D	
2.375	1.5	0.062	WAT62-2500-1500-E8D	
2.375	1.75	0.062	WAT62-2500-1750-E8D	
2.625	2.25	0.25	0.187	WAT187-2625-250-E8D
	2.25	0.312	0.187	WAT187-2625-312-E8D
	2.25	0.375	0.187	WAT187-2625-375-E8D

Cylinder dimensions				Designation
D	d	L	S	
in.				-
2.625 cont.	2.25	0.375	0.187	WAT187-2625-375-E8D
	2.25	0.5	0.187	WAT187-2625-500-E8D
	2.25	0.625	0.187	WAT187-2625-625-E8D
	2.25	0.75	0.187	WAT187-2625-750-E8D
	2.25	0.875	0.187	WAT187-2625-875-E8D
	2.25	1	0.187	WAT187-2625-1000-E8D
	2.25	1.25	0.187	WAT187-2625-1250-E8D
	2.25	1.5	0.187	WAT187-2625-1500-E8D
	2.25	1.75	0.187	WAT187-2625-1750-E8D
	2.375	0.25	0.125	WAT125-2625-250-E8D
	2.375	0.312	0.125	WAT125-2625-312-E8D
	2.375	0.375	0.125	WAT125-2625-375-E8D
	2.375	0.5	0.125	WAT125-2625-500-E8D
	2.375	0.625	0.125	WAT125-2625-625-E8D
	2.375	0.75	0.125	WAT125-2625-750-E8D
2.375	0.875	0.125	WAT125-2625-875-E8D	
2.375	1	0.125	WAT125-2625-1000-E8D	
2.375	1.25	0.125	WAT125-2625-1250-E8D	
2.375	1.5	0.125	WAT125-2625-1500-E8D	
2.375	1.75	0.125	WAT125-2625-1750-E8D	
2.438	0.25	0.093	WAT93-2625-250-E8D	
2.438	0.312	0.093	WAT93-2625-312-E8D	
2.438	0.375	0.093	WAT93-2625-375-E8D	
2.438	0.5	0.093	WAT93-2625-500-E8D	
2.438	0.625	0.093	WAT93-2625-625-E8D	
2.438	0.75	0.093	WAT93-2625-750-E8D	
2.438	0.875	0.093	WAT93-2625-875-E8D	
2.438	1	0.093	WAT93-2625-1000-E8D	
2.438	1.25	0.093	WAT93-2625-1250-E8D	
2.438	1.5	0.093	WAT93-2625-1500-E8D	
2.438	1.75	0.093	WAT93-2625-1750-E8D	
2.5	0.25	0.062	WAT62-2625-250-E8D	
2.5	0.312	0.062	WAT62-2625-312-E8D	
2.5	0.375	0.062	WAT62-2625-375-E8D	
2.5	0.5	0.062	WAT62-2625-500-E8D	

Cylinder dimensions				Designation	
D	d	L	S		
in.				-	
2.625 cont.	2.5	0.625	0.062	WAT62-2625-625-E8D	
	2.5	0.75	0.062	WAT62-2625-750-E8D	
2.75	2.5	0.875	0.062	WAT62-2625-875-E8D	
	2.5	1	0.062	WAT62-2625-1000-E8D	
	2.5	1.25	0.062	WAT62-2625-1250-E8D	
	2.5	1.5	0.062	WAT62-2625-1500-E8D	
	2.5	1.75	0.062	WAT62-2625-1750-E8D	
	2.375	0.25	0.187	WAT187-2750-250-E8D	
	2.375	0.312	0.187	WAT187-2750-312-E8D	
	2.375	0.375	0.187	WAT187-2750-375-E8D	
	2.375	0.5	0.187	WAT187-2750-500-E8D	
	2.375	0.625	0.187	WAT187-2750-625-E8D	
2.375	0.75	0.187	WAT187-2750-750-E8D		
2.875	2.375	0.875	0.187	WAT187-2750-875-E8D	
	2.375	1	0.187	WAT187-2750-1000-E8D	
	2.375	1.25	0.187	WAT187-2750-1250-E8D	
	2.375	1.5	0.187	WAT187-2750-1500-E8D	
	2.375	1.75	0.187	WAT187-2750-1750-E8D	
	2.375	2	0.187	WAT187-2750-2000-E8D	
	2.5	0.25	0.125	WAT125-2750-250-E8D	
	2.5	0.312	0.125	WAT125-2750-312-E8D	
	2.5	0.375	0.125	WAT125-2750-375-E8D	
	2.5	0.5	0.125	WAT125-2750-500-E8D	
2.5	0.625	0.125	WAT125-2750-625-E8D		
2.5	0.75	0.125	WAT125-2750-750-E8D		
2.563	2.5	0.875	0.125	WAT125-2750-875-E8D	
	2.5	1	0.125	WAT125-2750-1000-E8D	
	2.5	1.25	0.125	WAT125-2750-1250-E8D	
	2.5	1.5	0.125	WAT125-2750-1500-E8D	
	2.5	1.75	0.125	WAT125-2750-1750-E8D	
	2.5	2	0.125	WAT125-2750-2000-E8D	
	2.563	0.25	0.093	WAT93-2750-250-E8D	
	2.563	0.312	0.093	WAT93-2750-312-E8D	
	2.563	0.375	0.093	WAT93-2750-375-E8D	
	2.563	0.5	0.093	WAT93-2750-500-E8D	
2.563	0.625	0.093	WAT93-2750-625-E8D		
2.563	0.75	0.093	WAT93-2750-750-E8D		
2.563	0.875	0.093	WAT93-2750-875-E8D		
	2.563	1	0.093	WAT93-2750-1000-E8D	
	2.563	1.25	0.093	WAT93-2750-1250-E8D	
	2.563	1.5	0.093	WAT93-2750-1500-E8D	
	2.563	1.75	0.093	WAT93-2750-1750-E8D	
	2.563	2	0.093	WAT93-2750-2000-E8D	
	2.625	0.25	0.062	WAT62-2750-250-E8D	
	2.625	0.312	0.062	WAT62-2750-312-E8D	
	2.625	0.375	0.062	WAT62-2750-375-E8D	
	2.625	0.5	0.062	WAT62-2750-500-E8D	
2.625	0.625	0.062	WAT62-2750-625-E8D		
2.625	0.75	0.062	WAT62-2750-750-E8D		
2.625	0.875	0.062	WAT62-2750-875-E8D		
	2.625	1	0.062	WAT62-2750-1000-E8D	
	2.625	1.25	0.062	WAT62-2750-1250-E8D	
	2.625	1.5	0.062	WAT62-2750-1500-E8D	
	2.625	1.75	0.062	WAT62-2750-1750-E8D	
	2.625	2	0.062	WAT62-2750-2000-E8D	
	3	2.625	0.25	0.187	WAT187-3000-250-E8D
		2.625	0.312	0.187	WAT187-3000-312-E8D

Cylinder dimensions				Designation	
D	d	L	S		
in.				-	
3 cont.	2.625	0.375	0.187	WAT187-3000-375-E8D	
	2.625	0.5	0.187	WAT187-3000-500-E8D	
2.625	0.625	0.187	WAT187-3000-625-E8D		
	0.75	0.187	WAT187-3000-750-E8D		
	0.875	0.187	WAT187-3000-875-E8D		
	1	0.187	WAT187-3000-1000-E8D		
	1.25	0.187	WAT187-3000-1250-E8D		
	1.5	0.187	WAT187-3000-1500-E8D		
	1.75	0.187	WAT187-3000-1750-E8D		
	2	0.187	WAT187-3000-2000-E8D		
	2.75	0.25	0.125	WAT125-3000-250-E8D	
	2.75	0.312	0.125	WAT125-3000-312-E8D	
2.75	0.375	0.125	WAT125-3000-375-E8D		
2.75	0.5	0.125	WAT125-3000-500-E8D		
2.75	0.625	0.125	WAT125-3000-625-E8D		
2.75	0.75	0.125	WAT125-3000-750-E8D		
2.813	0.875	0.125	WAT125-3000-875-E8D		
	2.75	1	0.125	WAT125-3000-1000-E8D	
	2.75	1.25	0.125	WAT125-3000-1250-E8D	
	2.75	1.5	0.125	WAT125-3000-1500-E8D	
	2.75	1.75	0.125	WAT125-3000-1750-E8D	
	2.75	2	0.125	WAT125-3000-2000-E8D	
	2.813	0.25	0.093	WAT93-3000-250-E8D	
	2.813	0.312	0.093	WAT93-3000-312-E8D	
	2.813	0.375	0.093	WAT93-3000-375-E8D	
	2.813	0.5	0.093	WAT93-3000-500-E8D	
2.813	0.625	0.093	WAT93-3000-625-E8D		
2.813	0.75	0.093	WAT93-3000-750-E8D		
2.813	0.875	0.093	WAT93-3000-875-E8D		
	2.813	1	0.093	WAT93-3000-1000-E8D	
	2.813	1.25	0.093	WAT93-3000-1250-E8D	
	2.813	1.5	0.093	WAT93-3000-1500-E8D	
	2.813	1.75	0.093	WAT93-3000-1750-E8D	
	2.813	2	0.093	WAT93-3000-2000-E8D	
	2.875	0.25	0.062	WAT62-3000-250-E8D	
	2.875	0.312	0.062	WAT62-3000-312-E8D	
	2.875	0.375	0.062	WAT62-3000-375-E8D	
	2.875	0.5	0.062	WAT62-3000-500-E8D	
2.875	0.625	0.062	WAT62-3000-625-E8D		
2.875	0.75	0.062	WAT62-3000-750-E8D		
2.875	0.875	0.062	WAT62-3000-875-E8D		
	2.875	1	0.062	WAT62-3000-1000-E8D	
	2.875	1.25	0.062	WAT62-3000-1250-E8D	
	2.875	1.5	0.062	WAT62-3000-1500-E8D	
	2.875	1.75	0.062	WAT62-3000-1750-E8D	
	2.875	2	0.062	WAT62-3000-2000-E8D	
	3.25	2.875	0.25	0.187	WAT187-3250-250-E8D
		2.875	0.312	0.187	WAT187-3250-312-E8D
	2.875	0.375	0.187	WAT187-3250-375-E8D	
		0.5	0.187	WAT187-3250-500-E8D	
0.625		0.187	WAT187-3250-625-E8D		
0.75		0.187	WAT187-3250-750-E8D		
0.875		0.187	WAT187-3250-875-E8D		
2.875		1	0.187	WAT187-3250-1000-E8D	
2.875		1.25	0.187	WAT187-3250-1250-E8D	
2.875		1.5	0.187	WAT187-3250-1500-E8D	
2.875		1.75	0.187	WAT187-3250-1750-E8D	
2.875		2	0.187	WAT187-3250-2000-E8D	

## 5.2 WAT rod or piston guide rings, inch sizes

D 3.25 – 4 in.

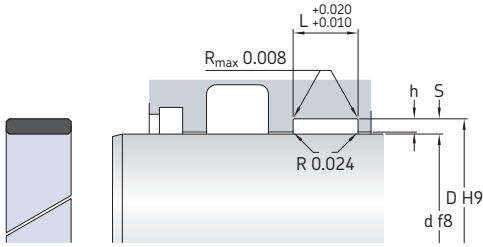

Rod application  
(dynamic on the inside surface)

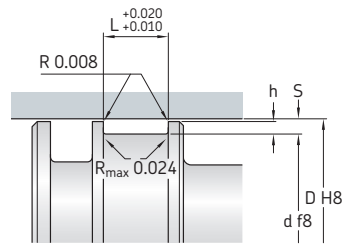

Piston application  
(dynamic on the outside surface)

$h \geq S/2$

Cylinder dimensions				Designation	Cylinder dimensions				Designation
D	d	L	S		D	d	L	S	
in.				-	in.				-
3.25 cont.	3	0.25	0.125	WAT125-3250-250-E8D	3.5	3.125	0.25	0.187	WAT187-3500-250-E8D
	3	0.312	0.125	WAT125-3250-312-E8D		3.125	0.312	0.187	WAT187-3500-312-E8D
	3	0.375	0.125	WAT125-3250-375-E8D		3.125	0.375	0.187	WAT187-3500-375-E8D
	3	0.5	0.125	WAT125-3250-500-E8D		3.125	0.5	0.187	WAT187-3500-500-E8D
	3	0.625	0.125	WAT125-3250-625-E8D		3.125	0.625	0.187	WAT187-3500-625-E8D
	3	0.75	0.125	WAT125-3250-750-E8D		3.125	0.75	0.187	WAT187-3500-750-E8D
	3	0.875	0.125	WAT125-3250-875-E8D		3.125	0.875	0.187	WAT187-3500-875-E8D
	3	1	0.125	WAT125-3250-1000-E8D		3.125	1	0.187	WAT187-3500-1000-E8D
	3	1.25	0.125	WAT125-3250-1250-E8D		3.125	1.25	0.187	WAT187-3500-1250-E8D
	3	1.5	0.125	WAT125-3250-1500-E8D		3.125	1.5	0.187	WAT187-3500-1500-E8D
	3	1.75	0.125	WAT125-3250-1750-E8D		3.125	1.75	0.187	WAT187-3500-1750-E8D
	3	2	0.125	WAT125-3250-2000-E8D		3.125	2	0.187	WAT187-3500-2000-E8D
	3.063	0.25	0.093	WAT93-3250-250-E8D		3.25	0.25	0.125	WAT125-3500-250-E8D
	3.063	0.312	0.093	WAT93-3250-312-E8D		3.25	0.312	0.125	WAT125-3500-312-E8D
	3.063	0.375	0.093	WAT93-3250-375-E8D		3.25	0.375	0.125	WAT125-3500-375-E8D
	3.063	0.5	0.093	WAT93-3250-500-E8D		3.25	0.5	0.125	WAT125-3500-500-E8D
	3.063	0.625	0.093	WAT93-3250-625-E8D		3.25	0.625	0.125	WAT125-3500-625-E8D
	3.063	0.75	0.093	WAT93-3250-750-E8D		3.25	0.75	0.125	WAT125-3500-750-E8D
	3.063	0.875	0.093	WAT93-3250-875-E8D		3.25	0.875	0.125	WAT125-3500-875-E8D
	3.063	1	0.093	WAT93-3250-1000-E8D		3.25	1	0.125	WAT125-3500-1000-E8D
3.063	1.25	0.093	WAT93-3250-1250-E8D	3.25	1.25	0.125	WAT125-3500-1250-E8D		
3.063	1.5	0.093	WAT93-3250-1500-E8D	3.25	1.5	0.125	WAT125-3500-1500-E8D		
3.063	1.75	0.093	WAT93-3250-1750-E8D	3.25	1.75	0.125	WAT125-3500-1750-E8D		
3.063	2	0.093	WAT93-3250-2000-E8D	3.25	2	0.125	WAT125-3500-2000-E8D		
3.125	0.25	0.062	WAT62-3250-250-E8D	3.313	0.25	0.093	WAT93-3500-250-E8D		
3.125	0.312	0.062	WAT62-3250-312-E8D	3.313	0.312	0.093	WAT93-3500-312-E8D		
3.125	0.375	0.062	WAT62-3250-375-E8D	3.313	0.375	0.093	WAT93-3500-375-E8D		
3.125	0.5	0.062	WAT62-3250-500-E8D	3.313	0.5	0.093	WAT93-3500-500-E8D		
3.125	0.625	0.062	WAT62-3250-625-E8D	3.313	0.625	0.093	WAT93-3500-625-E8D		
3.125	0.75	0.062	WAT62-3250-750-E8D	3.313	0.75	0.093	WAT93-3500-750-E8D		
3.125	0.875	0.062	WAT62-3250-875-E8D	3.313	0.875	0.093	WAT93-3500-875-E8D		
3.125	1	0.062	WAT62-3250-1000-E8D	3.313	1	0.093	WAT93-3500-1000-E8D		
3.125	1.25	0.062	WAT62-3250-1250-E8D	3.313	1.25	0.093	WAT93-3500-1250-E8D		
3.125	1.5	0.062	WAT62-3250-1500-E8D	3.313	1.5	0.093	WAT93-3500-1500-E8D		
3.125	1.75	0.062	WAT62-3250-1750-E8D	3.313	1.75	0.093	WAT93-3500-1750-E8D		
3.125	2	0.062	WAT62-3250-2000-E8D	3.313	2	0.093	WAT93-3500-2000-E8D		



Cylinder dimensions				Designation	
D	d	L	S		
in.				-	
3.5 cont.	3.375	0.25	0.062	WAT62-3500-250-E8D	
	3.375	0.312	0.062	WAT62-3500-312-E8D	
	3.375	0.375	0.062	WAT62-3500-375-E8D	
	3.375	0.5	0.062	WAT62-3500-500-E8D	
	3.375	0.625	0.062	WAT62-3500-625-E8D	
	3.375	0.75	0.062	WAT62-3500-750-E8D	
	3.375	0.875	0.062	WAT62-3500-875-E8D	
	3.375	1	0.062	WAT62-3500-1000-E8D	
	3.375	1.25	0.062	WAT62-3500-1250-E8D	
	3.375	1.5	0.062	WAT62-3500-1500-E8D	
	3.375	1.75	0.062	WAT62-3500-1750-E8D	
	3.375	2	0.062	WAT62-3500-2000-E8D	
	3.75	3.375	0.312	0.187	WAT187-3750-312-E8D
		3.375	0.375	0.187	WAT187-3750-375-E8D
		3.375	0.5	0.187	WAT187-3750-500-E8D
3.375		0.625	0.187	WAT187-3750-625-E8D	
3.375		0.75	0.187	WAT187-3750-750-E8D	
3.375		0.875	0.187	WAT187-3750-875-E8D	
3.375		1	0.187	WAT187-3750-1000-E8D	
3.375		1.25	0.187	WAT187-3750-1250-E8D	
3.375		1.5	0.187	WAT187-3750-1500-E8D	
3.375		1.75	0.187	WAT187-3750-1750-E8D	
3.375		2	0.187	WAT187-3750-2000-E8D	
3.5		0.312	0.125	WAT125-3750-312-E8D	
3.5		0.375	0.125	WAT125-3750-375-E8D	
3.5		0.5	0.125	WAT125-3750-500-E8D	
3.5		0.625	0.125	WAT125-3750-625-E8D	
3.5	0.75	0.125	WAT125-3750-750-E8D		
3.5	0.875	0.125	WAT125-3750-875-E8D		
3.5	1	0.125	WAT125-3750-1000-E8D		
3.5	1.25	0.125	WAT125-3750-1250-E8D		
3.5	1.5	0.125	WAT125-3750-1500-E8D		
3.5	1.75	0.125	WAT125-3750-1750-E8D		
3.5	2	0.125	WAT125-3750-2000-E8D		
3.563	0.312	0.093	WAT93-3750-312-E8D		
3.563	0.375	0.093	WAT93-3750-375-E8D		
3.563	0.5	0.093	WAT93-3750-500-E8D		
3.563	0.625	0.093	WAT93-3750-625-E8D		
3.563	0.75	0.093	WAT93-3750-750-E8D		
3.563	0.875	0.093	WAT93-3750-875-E8D		
3.563	1	0.093	WAT93-3750-1000-E8D		
3.563	1.25	0.093	WAT93-3750-1250-E8D		
3.563	1.5	0.093	WAT93-3750-1500-E8D		
3.563	1.75	0.093	WAT93-3750-1750-E8D		
3.563	2	0.093	WAT93-3750-2000-E8D		
3.625	0.312	0.062	WAT62-3750-312-E8D		
3.625	0.375	0.062	WAT62-3750-375-E8D		
3.625	0.5	0.062	WAT62-3750-500-E8D		
3.625	0.625	0.062	WAT62-3750-625-E8D		
3.625	0.75	0.062	WAT62-3750-750-E8D		
3.625	0.875	0.062	WAT62-3750-875-E8D		
3.625	1	0.062	WAT62-3750-1000-E8D		
3.625	1.25	0.062	WAT62-3750-1250-E8D		
3.625	1.5	0.062	WAT62-3750-1500-E8D		
3.625	1.75	0.062	WAT62-3750-1750-E8D		
3.625	2	0.062	WAT62-3750-2000-E8D		
3.875	3.5	0.312	0.187	WAT187-3875-312-E8D	
	3.5	0.375	0.187	WAT187-3875-375-E8D	

Cylinder dimensions				Designation
D	d	L	S	
in.				-
3.875 cont.	3.5	0.5	0.187	WAT187-3875-500-E8D
	3.5	0.625	0.187	WAT187-3875-625-E8D
	3.5	0.75	0.187	WAT187-3875-750-E8D
	3.5	0.875	0.187	WAT187-3875-875-E8D
	3.5	1	0.187	WAT187-3875-1000-E8D
	3.5	1.25	0.187	WAT187-3875-1250-E8D
	3.5	1.5	0.187	WAT187-3875-1500-E8D
	3.5	1.75	0.187	WAT187-3875-1750-E8D
	3.5	2	0.187	WAT187-3875-2000-E8D
	3.625	0.312	0.125	WAT125-3875-312-E8D
	3.625	0.375	0.125	WAT125-3875-375-E8D
	3.625	0.5	0.125	WAT125-3875-500-E8D
	3.625	0.625	0.125	WAT125-3875-625-E8D
	3.625	0.75	0.125	WAT125-3875-750-E8D
	3.625	0.875	0.125	WAT125-3875-875-E8D
3.625	1	0.125	WAT125-3875-1000-E8D	
3.625	1.25	0.125	WAT125-3875-1250-E8D	
3.625	1.5	0.125	WAT125-3875-1500-E8D	
3.625	1.75	0.125	WAT125-3875-1750-E8D	
3.625	2	0.125	WAT125-3875-2000-E8D	
3.688	0.312	0.093	WAT93-3875-312-E8D	
3.688	0.375	0.093	WAT93-3875-375-E8D	
3.688	0.5	0.093	WAT93-3875-500-E8D	
3.688	0.625	0.093	WAT93-3875-625-E8D	
3.688	0.75	0.093	WAT93-3875-750-E8D	
3.688	0.875	0.093	WAT93-3875-875-E8D	
3.688	1	0.093	WAT93-3875-1000-E8D	
3.688	1.25	0.093	WAT93-3875-1250-E8D	
3.688	1.5	0.093	WAT93-3875-1500-E8D	
3.688	1.75	0.093	WAT93-3875-1750-E8D	
3.688	2	0.093	WAT93-3875-2000-E8D	
3.75	0.312	0.062	WAT62-3875-312-E8D	
3.75	0.375	0.062	WAT62-3875-375-E8D	
3.75	0.5	0.062	WAT62-3875-500-E8D	
3.75	0.625	0.062	WAT62-3875-625-E8D	
3.75	0.75	0.062	WAT62-3875-750-E8D	
3.75	0.875	0.062	WAT62-3875-875-E8D	
3.75	1	0.062	WAT62-3875-1000-E8D	
3.75	1.25	0.062	WAT62-3875-1250-E8D	
3.75	1.5	0.062	WAT62-3875-1500-E8D	
3.75	1.75	0.062	WAT62-3875-1750-E8D	
3.75	2	0.062	WAT62-3875-2000-E8D	
4	3.625	0.312	0.187	WAT187-4000-312-E8D
	3.625	0.375	0.187	WAT187-4000-375-E8D
	3.625	0.5	0.187	WAT187-4000-500-E8D
	3.625	0.625	0.187	WAT187-4000-625-E8D
	3.625	0.75	0.187	WAT187-4000-750-E8D
	3.625	0.875	0.187	WAT187-4000-875-E8D
	3.625	1	0.187	WAT187-4000-1000-E8D
	3.625	1.25	0.187	WAT187-4000-1250-E8D
	3.625	1.5	0.187	WAT187-4000-1500-E8D
	3.625	1.75	0.187	WAT187-4000-1750-E8D
	3.625	2	0.187	WAT187-4000-2000-E8D
	3.75	0.312	0.125	WAT125-4000-312-E8D
	3.75	0.375	0.125	WAT125-4000-375-E8D
	3.75	0.5	0.125	WAT125-4000-500-E8D
	3.75	0.625	0.125	WAT125-4000-625-E8D
3.75	0.75	0.125	WAT125-4000-750-E8D	
3.75	0.875	0.125	WAT125-4000-875-E8D	

## 5.2 WAT rod or piston guide rings, inch sizes

D 4 – 5.25 in.

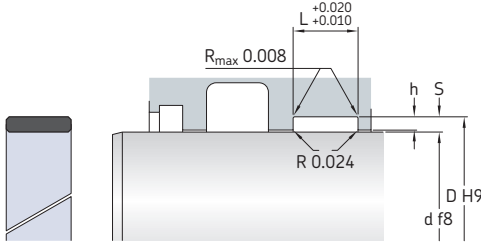

Rod application  
(dynamic on the inside surface)

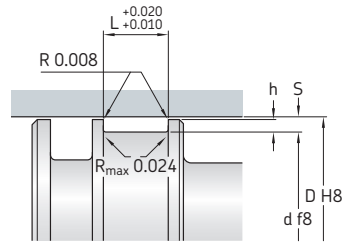

Piston application  
(dynamic on the outside surface)

$h \geq S/2$

Cylinder dimensions				Designation	Cylinder dimensions				Designation	
D	d	L	S		D	d	L	S		
in.										
4 cont.	3.75	1	0.125	WAT125-4000-1000-E8D	4.25 cont.	4.063	0.375	0.093	WAT93-4250-375-E8D	
	3.75	1.25	0.125	WAT125-4000-1250-E8D		4.063	0.5	0.093	WAT93-4250-500-E8D	
	3.75	1.5	0.125	WAT125-4000-1500-E8D		4.063	0.625	0.093	WAT93-4250-625-E8D	
	3.75	1.75	0.125	WAT125-4000-1750-E8D		4.063	0.75	0.093	WAT93-4250-750-E8D	
	3.75	2	0.125	WAT125-4000-2000-E8D		4.063	0.875	0.093	WAT93-4250-875-E8D	
	3.813	0.312	0.093	WAT93-4000-312-E8D		4.063	1	0.093	WAT93-4250-1000-E8D	
	3.813	0.375	0.093	WAT93-4000-375-E8D		4.063	1.25	0.093	WAT93-4250-1250-E8D	
	3.813	0.5	0.093	WAT93-4000-500-E8D		4.063	1.5	0.093	WAT93-4250-1500-E8D	
	3.813	0.625	0.093	WAT93-4000-625-E8D		4.063	1.75	0.093	WAT93-4250-1750-E8D	
	3.813	0.75	0.093	WAT93-4000-750-E8D		4.063	2	0.093	WAT93-4250-2000-E8D	
	3.813	0.875	0.093	WAT93-4000-875-E8D		4.5	4.125	0.375	0.187	WAT187-4500-375-E8D
	3.813	1	0.093	WAT93-4000-1000-E8D			4.125	0.5	0.187	WAT187-4500-500-E8D
3.813	1.25	0.093	WAT93-4000-1250-E8D	4.125	0.625		0.187	WAT187-4500-625-E8D		
3.813	1.5	0.093	WAT93-4000-1500-E8D	4.125	0.75		0.187	WAT187-4500-750-E8D		
3.813	1.75	0.093	WAT93-4000-1750-E8D	4.125	0.875		0.187	WAT187-4500-875-E8D		
3.813	2	0.093	WAT93-4000-2000-E8D	4.125	1		0.187	WAT187-4500-1000-E8D		
4.25	3.875	0.375	0.187	WAT187-4250-375-E8D	4.125		1.25	0.187	WAT187-4500-1250-E8D	
	3.875	0.5	0.187	WAT187-4250-500-E8D	4.125		1.5	0.187	WAT187-4500-1500-E8D	
	3.875	0.625	0.187	WAT187-4250-625-E8D	4.125		1.75	0.187	WAT187-4500-1750-E8D	
	3.875	0.75	0.187	WAT187-4250-750-E8D	4.125		2	0.187	WAT187-4500-2000-E8D	
	3.875	0.875	0.187	WAT187-4250-875-E8D	4.25		0.375	0.125	WAT125-4500-375-E8D	
	3.875	1	0.187	WAT187-4250-1000-E8D	4.25		0.5	0.125	WAT125-4500-500-E8D	
	3.875	1.25	0.187	WAT187-4250-1250-E8D	4.25	0.625	0.125	WAT125-4500-625-E8D		
	3.875	1.5	0.187	WAT187-4250-1500-E8D	4.25	0.75	0.125	WAT125-4500-750-E8D		
	3.875	1.75	0.187	WAT187-4250-1750-E8D	4.25	0.875	0.125	WAT125-4500-875-E8D		
	3.875	2	0.187	WAT187-4250-2000-E8D	4.25	1	0.125	WAT125-4500-1000-E8D		
	4	0.375	0.125	WAT125-4250-375-E8D	4.25	1.25	0.125	WAT125-4500-1250-E8D		
	4	0.5	0.125	WAT125-4250-500-E8D	4.25	1.5	0.125	WAT125-4500-1500-E8D		
4	0.625	0.125	WAT125-4250-625-E8D	4.25	1.75	0.125	WAT125-4500-1750-E8D			
4	0.75	0.125	WAT125-4250-750-E8D	4.25	2	0.125	WAT125-4500-2000-E8D			
4	0.875	0.125	WAT125-4250-875-E8D	4.313	0.375	0.093	WAT93-4500-375-E8D			
4	1	0.125	WAT125-4250-1000-E8D		0.5	0.093	WAT93-4500-500-E8D			
4	1.25	0.125	WAT125-4250-1250-E8D		0.625	0.093	WAT93-4500-625-E8D			
4	1.5	0.125	WAT125-4250-1500-E8D		0.75	0.093	WAT93-4500-750-E8D			
4	1.75	0.125	WAT125-4250-1750-E8D		0.875	0.093	WAT93-4500-875-E8D			
4	2	0.125	WAT125-4250-2000-E8D							

Cylinder dimensions				Designation
D	d	L	S	
in.				-
2.625 cont.	4.313	1	0.093	WAT93-4500-1000-E8D
	4.313	1.25	0.093	WAT93-4500-1250-E8D
	4.313	1.5	0.093	WAT93-4500-1500-E8D
	4.313	1.75	0.093	WAT93-4500-1750-E8D
	4.313	2	0.093	WAT93-4500-2000-E8D
4.75	4.375	0.375	0.187	WAT187-4750-375-E8D
	4.375	0.5	0.187	WAT187-4750-500-E8D
	4.375	0.625	0.187	WAT187-4750-625-E8D
	4.375	0.75	0.187	WAT187-4750-750-E8D
	4.375	0.875	0.187	WAT187-4750-875-E8D
	4.375	1	0.187	WAT187-4750-1000-E8D
	4.375	1.25	0.187	WAT187-4750-1250-E8D
	4.375	1.5	0.187	WAT187-4750-1500-E8D
	4.375	1.75	0.187	WAT187-4750-1750-E8D
	4.375	2	0.187	WAT187-4750-2000-E8D
4.5	4.5	0.375	0.125	WAT125-4750-375-E8D
	4.5	0.5	0.125	WAT125-4750-500-E8D
	4.5	0.625	0.125	WAT125-4750-625-E8D
	4.5	0.75	0.125	WAT125-4750-750-E8D
	4.5	0.875	0.125	WAT125-4750-875-E8D
	4.5	1	0.125	WAT125-4750-1000-E8D
	4.5	1.25	0.125	WAT125-4750-1250-E8D
	4.5	1.5	0.125	WAT125-4750-1500-E8D
	4.5	1.75	0.125	WAT125-4750-1750-E8D
	4.5	2	0.125	WAT125-4750-2000-E8D
4.563	4.563	0.375	0.093	WAT93-4750-375-E8D
	4.563	0.5	0.093	WAT93-4750-500-E8D
	4.563	0.625	0.093	WAT93-4750-625-E8D
	4.563	0.75	0.093	WAT93-4750-750-E8D
	4.563	0.875	0.093	WAT93-4750-875-E8D
	4.563	1	0.093	WAT93-4750-1000-E8D
	4.563	1.25	0.093	WAT93-4750-1250-E8D
	4.563	1.5	0.093	WAT93-4750-1500-E8D
	4.563	1.75	0.093	WAT93-4750-1750-E8D
	4.563	2	0.093	WAT93-4750-2000-E8D
4.875	4.5	0.375	0.187	WAT187-4875-375-E8D
	4.5	0.5	0.187	WAT187-4875-500-E8D
	4.5	0.625	0.187	WAT187-4875-625-E8D
	4.5	0.75	0.187	WAT187-4875-750-E8D
	4.5	0.875	0.187	WAT187-4875-875-E8D
	4.5	1	0.187	WAT187-4875-1000-E8D
	4.5	1.25	0.187	WAT187-4875-1250-E8D
	4.5	1.5	0.187	WAT187-4875-1500-E8D
	4.5	1.75	0.187	WAT187-4875-1750-E8D
	4.5	2	0.187	WAT187-4875-2000-E8D
4.625	4.625	0.375	0.125	WAT125-4875-375-E8D
	4.625	0.5	0.125	WAT125-4875-500-E8D
	4.625	0.625	0.125	WAT125-4875-625-E8D
	4.625	0.75	0.125	WAT125-4875-750-E8D
	4.625	0.875	0.125	WAT125-4875-875-E8D
	4.625	1	0.125	WAT125-4875-1000-E8D
	4.625	1.25	0.125	WAT125-4875-1250-E8D
	4.625	1.5	0.125	WAT125-4875-1500-E8D
	4.625	1.75	0.125	WAT125-4875-1750-E8D
	4.625	2	0.125	WAT125-4875-2000-E8D
4.688	4.688	0.375	0.093	WAT93-4875-375-E8D
	4.688	0.5	0.093	WAT93-4875-500-E8D

Cylinder dimensions				Designation	
D	d	L	S		
in.				-	
4.875 cont.	4.688	0.625	0.093	WAT93-4875-625-E8D	
	4.688	0.75	0.093	WAT93-4875-750-E8D	
	4.688	0.875	0.093	WAT93-4875-875-E8D	
4.688	4.688	1	0.093	WAT93-4875-1000-E8D	
	4.688	1.25	0.093	WAT93-4875-1250-E8D	
	4.688	1.5	0.093	WAT93-4875-1500-E8D	
	4.688	1.75	0.093	WAT93-4875-1750-E8D	
	4.688	2	0.093	WAT93-4875-2000-E8D	
5	4.625	0.375	0.187	WAT187-5000-375-E8D	
	4.625	0.5	0.187	WAT187-5000-500-E8D	
	4.625	0.625	0.187	WAT187-5000-625-E8D	
	4.625	0.75	0.187	WAT187-5000-750-E8D	
	4.625	0.875	0.187	WAT187-5000-875-E8D	
	4.625	1	0.187	WAT187-5000-1000-E8D	
	4.625	1.25	0.187	WAT187-5000-1250-E8D	
	4.625	1.5	0.187	WAT187-5000-1500-E8D	
	4.625	1.75	0.187	WAT187-5000-1750-E8D	
	4.625	2	0.187	WAT187-5000-2000-E8D	
4.75	4.75	0.375	0.125	WAT125-5000-375-E8D	
	4.75	0.5	0.125	WAT125-5000-500-E8D	
	4.75	0.625	0.125	WAT125-5000-625-E8D	
	4.75	0.75	0.125	WAT125-5000-750-E8D	
	4.75	0.875	0.125	WAT125-5000-875-E8D	
4.75	4.75	1	0.125	WAT125-5000-1000-E8D	
	4.75	1.25	0.125	WAT125-5000-1250-E8D	
	4.75	1.5	0.125	WAT125-5000-1500-E8D	
	4.75	1.75	0.125	WAT125-5000-1750-E8D	
	4.75	2	0.125	WAT125-5000-2000-E8D	
4.813	4.813	0.375	0.093	WAT93-5000-375-E8D	
	4.813	0.5	0.093	WAT93-5000-500-E8D	
	4.813	0.625	0.093	WAT93-5000-625-E8D	
	4.813	0.75	0.093	WAT93-5000-750-E8D	
	4.813	0.875	0.093	WAT93-5000-875-E8D	
4.813	4.813	1	0.093	WAT93-5000-1000-E8D	
	4.813	1.25	0.093	WAT93-5000-1250-E8D	
	4.813	1.5	0.093	WAT93-5000-1500-E8D	
	4.813	1.75	0.093	WAT93-5000-1750-E8D	
	4.813	2	0.093	WAT93-5000-2000-E8D	
5.25	4.875	0.375	0.187	WAT187-5250-375-E8D	
	4.875	0.5	0.187	WAT187-5250-500-E8D	
	4.875	0.625	0.187	WAT187-5250-625-E8D	
	4.875	0.75	0.187	WAT187-5250-750-E8D	
	4.875	0.875	0.187	WAT187-5250-875-E8D	
4.875	4.875	1	0.187	WAT187-5250-1000-E8D	
	4.875	1.25	0.187	WAT187-5250-1250-E8D	
	4.875	1.5	0.187	WAT187-5250-1500-E8D	
	4.875	1.75	0.187	WAT187-5250-1750-E8D	
	4.875	2	0.187	WAT187-5250-2000-E8D	
	4.875	2.25	0.187	WAT187-5250-2250-E8D	
	4.875	2.5	0.187	WAT187-5250-2500-E8D	
	5	5	0.375	0.125	WAT125-5250-375-E8D
		5	0.5	0.125	WAT125-5250-500-E8D
		5	0.625	0.125	WAT125-5250-625-E8D
5		0.75	0.125	WAT125-5250-750-E8D	
5		0.875	0.125	WAT125-5250-875-E8D	
5	1	0.125	WAT125-5250-1000-E8D		

## 5.2 WAT rod or piston guide rings, inch sizes

D 5.25 – 6.75 in.

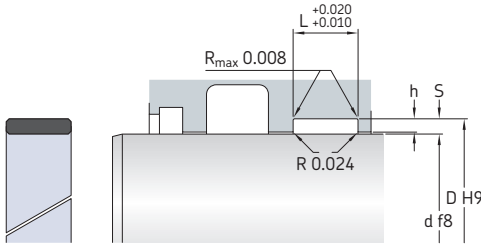

Rod application  
(dynamic on the inside surface)

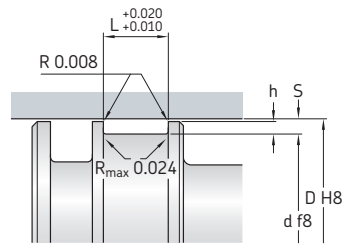

Piston application  
(dynamic on the outside surface)

$h \geq S/2$

Cylinder dimensions				Designation
D	d	L	S	
in.				-
5.25 cont.	5	1.25	0.125	WAT125-5250-1250-E8D
	5	1.5	0.125	WAT125-5250-1500-E8D
	5	1.75	0.125	WAT125-5250-1750-E8D
	5	2	0.125	WAT125-5250-2000-E8D
	5	2.25	0.125	WAT125-5250-2250-E8D
	5	2.5	0.125	WAT125-5250-2500-E8D
	5.063	0.375	0.093	WAT93-5250-375-E8D
	5.063	0.5	0.093	WAT93-5250-500-E8D
	5.063	0.625	0.093	WAT93-5250-625-E8D
	5.063	0.75	0.093	WAT93-5250-750-E8D
5.063	0.875	0.093	WAT93-5250-875-E8D	
5.063	1	0.093	WAT93-5250-1000-E8D	
5.063	1.25	0.093	WAT93-5250-1250-E8D	
5.063	1.5	0.093	WAT93-5250-1500-E8D	
5.063	1.75	0.093	WAT93-5250-1750-E8D	
5.063	2	0.093	WAT93-5250-2000-E8D	
5.063	2.25	0.093	WAT93-5250-2250-E8D	
5.063	2.5	0.093	WAT93-5250-2500-E8D	
5.5	5.125	0.375	0.187	WAT187-5500-375-E8D
	5.125	0.5	0.187	WAT187-5500-500-E8D
	5.125	0.625	0.187	WAT187-5500-625-E8D
	5.125	0.75	0.187	WAT187-5500-750-E8D
	5.125	0.875	0.187	WAT187-5500-875-E8D
	5.125	1	0.187	WAT187-5500-1000-E8D
	5.125	1.25	0.187	WAT187-5500-1250-E8D
	5.125	1.5	0.187	WAT187-5500-1500-E8D
	5.125	1.75	0.187	WAT187-5500-1750-E8D
	5.125	2	0.187	WAT187-5500-2000-E8D
5.25	0.375	0.125	WAT125-5500-375-E8D	
5.25	0.5	0.125	WAT125-5500-500-E8D	
5.25	0.625	0.125	WAT125-5500-625-E8D	
5.25	0.75	0.125	WAT125-5500-750-E8D	
5.25	0.875	0.125	WAT125-5500-875-E8D	
5.25	1	0.125	WAT125-5500-1000-E8D	
5.25	1.25	0.125	WAT125-5500-1250-E8D	

Cylinder dimensions				Designation
D	d	L	S	
in.				-
5.5 cont.	5.25	1.5	0.125	WAT125-5500-1500-E8D
	5.25	1.75	0.125	WAT125-5500-1750-E8D
	5.25	2	0.125	WAT125-5500-2000-E8D
	5.313	0.375	0.093	WAT93-5500-375-E8D
	5.313	0.5	0.093	WAT93-5500-500-E8D
	5.313	0.625	0.093	WAT93-5500-625-E8D
	5.313	0.75	0.093	WAT93-5500-750-E8D
	5.313	0.875	0.093	WAT93-5500-875-E8D
	5.313	1	0.093	WAT93-5500-1000-E8D
	5.313	1.25	0.093	WAT93-5500-1250-E8D
5.313	1.5	0.093	WAT93-5500-1500-E8D	
5.313	1.75	0.093	WAT93-5500-1750-E8D	
5.313	2	0.093	WAT93-5500-2000-E8D	
5.625	5.25	0.375	0.187	WAT187-5625-375-E8D
	5.25	0.5	0.187	WAT187-5625-500-E8D
	5.25	0.625	0.187	WAT187-5625-625-E8D
	5.25	0.75	0.187	WAT187-5625-750-E8D
	5.25	0.875	0.187	WAT187-5625-875-E8D
	5.25	1	0.187	WAT187-5625-1000-E8D
	5.25	1.25	0.187	WAT187-5625-1250-E8D
	5.25	1.5	0.187	WAT187-5625-1500-E8D
	5.25	1.75	0.187	WAT187-5625-1750-E8D
	5.25	2	0.187	WAT187-5625-2000-E8D
5.375	0.375	0.125	WAT125-5625-375-E8D	
5.375	0.5	0.125	WAT125-5625-500-E8D	
5.375	0.625	0.125	WAT125-5625-625-E8D	
5.375	0.75	0.125	WAT125-5625-750-E8D	
5.375	0.875	0.125	WAT125-5625-875-E8D	
5.375	1	0.125	WAT125-5625-1000-E8D	
5.375	1.25	0.125	WAT125-5625-1250-E8D	
5.375	1.5	0.125	WAT125-5625-1500-E8D	
5.375	1.75	0.125	WAT125-5625-1750-E8D	
5.375	2	0.125	WAT125-5625-2000-E8D	
5.438	0.375	0.093	WAT93-5625-375-E8D	
5.438	0.5	0.093	WAT93-5625-500-E8D	

Cylinder dimensions				Designation	
D	d	L	S		
in.					
5.625 cont.	5.438	0.625	0.093	WAT93-5625-625-E8D	
	5.438	0.75	0.093	WAT93-5625-750-E8D	
	5.438	0.875	0.093	WAT93-5625-875-E8D	
	5.438	1	0.093	WAT93-5625-1000-E8D	
	5.438	1.25	0.093	WAT93-5625-1250-E8D	
	5.438	1.5	0.093	WAT93-5625-1500-E8D	
	5.438	1.75	0.093	WAT93-5625-1750-E8D	
	5.438	2	0.093	WAT93-5625-2000-E8D	
	5.75	5.375	0.375	0.187	WAT187-5750-375-E8D
		5.375	0.5	0.187	WAT187-5750-500-E8D
5.375		0.625	0.187	WAT187-5750-625-E8D	
5.375		0.75	0.187	WAT187-5750-750-E8D	
5.375		0.875	0.187	WAT187-5750-875-E8D	
5.375		1	0.187	WAT187-5750-1000-E8D	
5.375		1.25	0.187	WAT187-5750-1250-E8D	
5.375		1.5	0.187	WAT187-5750-1500-E8D	
5.375		1.75	0.187	WAT187-5750-1750-E8D	
5.375		2	0.187	WAT187-5750-2000-E8D	
5.5	5.5	0.375	0.125	WAT125-5750-375-E8D	
	5.5	0.5	0.125	WAT125-5750-500-E8D	
	5.5	0.625	0.125	WAT125-5750-625-E8D	
	5.5	0.75	0.125	WAT125-5750-750-E8D	
	5.5	0.875	0.125	WAT125-5750-875-E8D	
	5.5	1	0.125	WAT125-5750-1000-E8D	
	5.5	1.25	0.125	WAT125-5750-1250-E8D	
	5.5	1.5	0.125	WAT125-5750-1500-E8D	
	5.5	1.75	0.125	WAT125-5750-1750-E8D	
	5.5	2	0.125	WAT125-5750-2000-E8D	
5.563	5.563	0.375	0.093	WAT93-5750-375-E8D	
	5.563	0.5	0.093	WAT93-5750-500-E8D	
	5.563	0.625	0.093	WAT93-5750-625-E8D	
	5.563	0.75	0.093	WAT93-5750-750-E8D	
	5.563	0.875	0.093	WAT93-5750-875-E8D	
	5.563	1	0.093	WAT93-5750-1000-E8D	
	5.563	1.25	0.093	WAT93-5750-1250-E8D	
	5.563	1.5	0.093	WAT93-5750-1500-E8D	
	5.563	1.75	0.093	WAT93-5750-1750-E8D	
	5.563	2	0.093	WAT93-5750-2000-E8D	
6	5.625	0.375	0.187	WAT187-6000-375-E8D	
	5.625	0.5	0.187	WAT187-6000-500-E8D	
	5.625	0.625	0.187	WAT187-6000-625-E8D	
	5.625	0.75	0.187	WAT187-6000-750-E8D	
	5.625	0.875	0.187	WAT187-6000-875-E8D	
	5.625	1	0.187	WAT187-6000-1000-E8D	
	5.625	1.25	0.187	WAT187-6000-1250-E8D	
	5.625	1.5	0.187	WAT187-6000-1500-E8D	
	5.625	1.75	0.187	WAT187-6000-1750-E8D	
	5.625	2	0.187	WAT187-6000-2000-E8D	
5.75	5.75	0.375	0.125	WAT125-6000-375-E8D	
	5.75	0.5	0.125	WAT125-6000-500-E8D	
	5.75	0.625	0.125	WAT125-6000-625-E8D	
	5.75	0.75	0.125	WAT125-6000-750-E8D	
	5.75	0.875	0.125	WAT125-6000-875-E8D	
	5.75	1	0.125	WAT125-6000-1000-E8D	
	5.75	1.25	0.125	WAT125-6000-1250-E8D	
	5.75	1.5	0.125	WAT125-6000-1500-E8D	
	5.75	1.75	0.125	WAT125-6000-1750-E8D	
	5.75	2	0.125	WAT125-6000-2000-E8D	

Cylinder dimensions				Designation
D	d	L	S	
in.				
6.25	5.875	0.5	0.187	WAT187-6250-500-E8D
	5.875	0.625	0.187	WAT187-6250-625-E8D
	5.875	0.75	0.187	WAT187-6250-750-E8D
	5.875	0.875	0.187	WAT187-6250-875-E8D
	5.875	1	0.187	WAT187-6250-1000-E8D
	5.875	1.25	0.187	WAT187-6250-1250-E8D
	5.875	1.5	0.187	WAT187-6250-1500-E8D
	5.875	1.75	0.187	WAT187-6250-1750-E8D
	5.875	2	0.187	WAT187-6250-2000-E8D
	6	6	0.5	0.125
6		0.625	0.125	WAT125-6250-625-E8D
6		0.75	0.125	WAT125-6250-750-E8D
6		0.875	0.125	WAT125-6250-875-E8D
6		1	0.125	WAT125-6250-1000-E8D
6		1.25	0.125	WAT125-6250-1250-E8D
6		1.5	0.125	WAT125-6250-1500-E8D
6		1.75	0.125	WAT125-6250-1750-E8D
6		2	0.125	WAT125-6250-2000-E8D
6.5		6.125	0.5	0.187
	6.125	0.625	0.187	WAT187-6500-625-E8D
	6.125	0.75	0.187	WAT187-6500-750-E8D
	6.125	0.875	0.187	WAT187-6500-875-E8D
	6.125	1	0.187	WAT187-6500-1000-E8D
	6.125	1.25	0.187	WAT187-6500-1250-E8D
	6.125	1.5	0.187	WAT187-6500-1500-E8D
	6.125	1.75	0.187	WAT187-6500-1750-E8D
	6.125	2	0.187	WAT187-6500-2000-E8D
	6.25	6.25	0.5	0.125
6.25		0.625	0.125	WAT125-6500-625-E8D
6.25		0.75	0.125	WAT125-6500-750-E8D
6.25		0.875	0.125	WAT125-6500-875-E8D
6.25		1	0.125	WAT125-6500-1000-E8D
6.25		1.25	0.125	WAT125-6500-1250-E8D
6.25		1.5	0.125	WAT125-6500-1500-E8D
6.25		1.75	0.125	WAT125-6500-1750-E8D
6.25		2	0.125	WAT125-6500-2000-E8D
6.75		6.375	0.5	0.187
	6.375	0.625	0.187	WAT187-6750-625-E8D
	6.375	0.75	0.187	WAT187-6750-750-E8D
	6.375	0.875	0.187	WAT187-6750-875-E8D
	6.375	1	0.187	WAT187-6750-1000-E8D
	6.375	1.25	0.187	WAT187-6750-1250-E8D
	6.375	1.5	0.187	WAT187-6750-1500-E8D
	6.375	1.75	0.187	WAT187-6750-1750-E8D
	6.375	2	0.187	WAT187-6750-2000-E8D
	6.5	6.5	0.5	0.125
6.5		0.625	0.125	WAT125-6750-625-E8D
6.5		0.75	0.125	WAT125-6750-750-E8D
6.5		0.875	0.125	WAT125-6750-875-E8D
6.5		1	0.125	WAT125-6750-1000-E8D
6.5		1.25	0.125	WAT125-6750-1250-E8D
6.5		1.5	0.125	WAT125-6750-1500-E8D
6.5		1.75	0.125	WAT125-6750-1750-E8D
6.5		2	0.125	WAT125-6750-2000-E8D

## 5.2 WAT rod or piston guide rings, inch sizes

D 7 – 9.5 in.

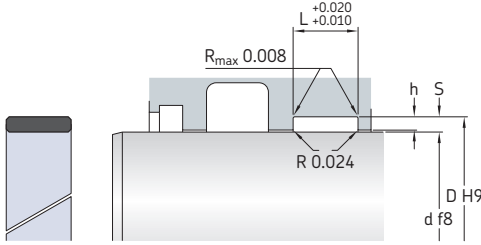

Rod application  
(dynamic on the inside surface)

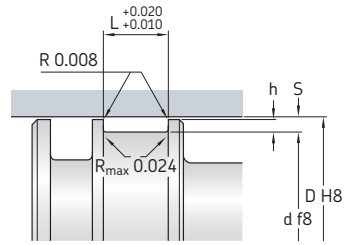

Piston application  
(dynamic on the outside surface)

$h \geq S/2$

Cylinder dimensions				Designation
D	d	L	S	
in.				-
7	6.625	0.5	0.187	WAT187-7000-500-E8D
	6.625	0.625	0.187	WAT187-7000-625-E8D
	6.625	0.75	0.187	WAT187-7000-750-E8D
	6.625	0.875	0.187	WAT187-7000-875-E8D
	6.625	1	0.187	WAT187-7000-1000-E8D
	6.625	1.25	0.187	WAT187-7000-1250-E8D
	6.625	1.5	0.187	WAT187-7000-1500-E8D
	6.625	1.75	0.187	WAT187-7000-1750-E8D
	6.625	2	0.187	WAT187-7000-2000-E8D
	6.75	0.5	0.125	WAT125-7000-500-E8D
	6.75	0.625	0.125	WAT125-7000-625-E8D
	6.75	0.75	0.125	WAT125-7000-750-E8D
6.75	0.875	0.125	WAT125-7000-875-E8D	
7.25	6.75	1	0.125	WAT125-7000-1000-E8D
	6.75	1.25	0.125	WAT125-7000-1250-E8D
	6.75	1.5	0.125	WAT125-7000-1500-E8D
	6.75	1.75	0.125	WAT125-7000-1750-E8D
	6.75	2	0.125	WAT125-7000-2000-E8D
	6.875	0.5	0.187	WAT187-7250-500-E8D
	6.875	0.625	0.187	WAT187-7250-625-E8D
	6.875	0.75	0.187	WAT187-7250-750-E8D
	6.875	0.875	0.187	WAT187-7250-875-E8D
	6.875	1	0.187	WAT187-7250-1000-E8D
	6.875	1.25	0.187	WAT187-7250-1250-E8D
	6.875	1.5	0.187	WAT187-7250-1500-E8D
6.875	1.75	0.187	WAT187-7250-1750-E8D	
6.875	2	0.187	WAT187-7250-2000-E8D	
7	0.5	0.125	WAT125-7250-500-E8D	
7	0.625	0.125	WAT125-7250-625-E8D	
7	0.75	0.125	WAT125-7250-750-E8D	
7	0.875	0.125	WAT125-7250-875-E8D	

Cylinder dimensions				Designation
D	d	L	S	
in.				-
7.25 cont.	7	1	0.125	WAT125-7250-1000-E8D
	7	1.25	0.125	WAT125-7250-1250-E8D
	7	1.5	0.125	WAT125-7250-1500-E8D
	7	1.75	0.125	WAT125-7250-1750-E8D
	7	2	0.125	WAT125-7250-2000-E8D
7.5	7.125	0.5	0.187	WAT187-7500-500-E8D
	7.125	0.625	0.187	WAT187-7500-625-E8D
	7.125	0.75	0.187	WAT187-7500-750-E8D
	7.125	0.875	0.187	WAT187-7500-875-E8D
	7.125	1	0.187	WAT187-7500-1000-E8D
	7.125	1.25	0.187	WAT187-7500-1250-E8D
	7.125	1.5	0.187	WAT187-7500-1500-E8D
	7.125	1.75	0.187	WAT187-7500-1750-E8D
	7.125	2	0.187	WAT187-7500-2000-E8D
	7.25	0.5	0.125	WAT125-7500-500-E8D
	7.25	0.625	0.125	WAT125-7500-625-E8D
	7.25	0.75	0.125	WAT125-7500-750-E8D
7.25	0.875	0.125	WAT125-7500-875-E8D	
7.25	7.25	1	0.125	WAT125-7500-1000-E8D
	7.25	1.25	0.125	WAT125-7500-1250-E8D
	7.25	1.5	0.125	WAT125-7500-1500-E8D
	7.25	1.75	0.125	WAT125-7500-1750-E8D
	7.25	2	0.125	WAT125-7500-2000-E8D
7.75	7.375	0.625	0.187	WAT187-7750-625-E8D
	7.375	0.75	0.187	WAT187-7750-750-E8D
	7.375	0.875	0.187	WAT187-7750-875-E8D
	7.375	1	0.187	WAT187-7750-1000-E8D
	7.375	1.25	0.187	WAT187-7750-1250-E8D
7.375	1.5	0.187	WAT187-7750-1500-E8D	
7.375	1.75	0.187	WAT187-7750-1750-E8D	
7.375	2	0.187	WAT187-7750-2000-E8D	
7.5	0.625	0.125	WAT125-7750-625-E8D	
7.5	0.75	0.125	WAT125-7750-750-E8D	
7.5	0.875	0.125	WAT125-7750-875-E8D	
7.5	1	0.125	WAT125-7750-1000-E8D	

Cylinder dimensions				Designation
D	d	L	S	
in.				-
<b>7.75</b> cont.	7.5	1.25	0.125	WAT125-7750-1250-E8D
	7.5	1.5	0.125	WAT125-7750-1500-E8D
	7.5	1.75	0.125	WAT125-7750-1750-E8D
	7.5	2	0.125	WAT125-7750-2000-E8D
<b>8</b>	7.625	0.625	0.187	WAT187-8000-625-E8D
	7.625	0.75	0.187	WAT187-8000-750-E8D
	7.625	0.875	0.187	WAT187-8000-875-E8D
	7.625	1	0.187	WAT187-8000-1000-E8D
	7.625	1.25	0.187	WAT187-8000-1250-E8D
	7.625	1.5	0.187	WAT187-8000-1500-E8D
	7.625	1.75	0.187	WAT187-8000-1750-E8D
	7.625	2	0.187	WAT187-8000-2000-E8D
	7.75	0.625	0.125	WAT125-8000-625-E8D
	7.75	0.75	0.125	WAT125-8000-750-E8D
	7.75	0.875	0.125	WAT125-8000-875-E8D
	7.75	1	0.125	WAT125-8000-1000-E8D
7.75	1.25	0.125	WAT125-8000-1250-E8D	
7.75	1.5	0.125	WAT125-8000-1500-E8D	
7.75	1.75	0.125	WAT125-8000-1750-E8D	
7.75	2	0.125	WAT125-8000-2000-E8D	
<b>8.25</b>	7.875	0.625	0.187	WAT187-8250-625-E8D
	7.875	0.75	0.187	WAT187-8250-750-E8D
	7.875	0.875	0.187	WAT187-8250-875-E8D
	7.875	1	0.187	WAT187-8250-1000-E8D
	7.875	1.25	0.187	WAT187-8250-1250-E8D
	7.875	1.5	0.187	WAT187-8250-1500-E8D
	7.875	1.75	0.187	WAT187-8250-1750-E8D
	7.875	2	0.187	WAT187-8250-2000-E8D
	8	0.625	0.125	WAT125-8250-625-E8D
	8	0.75	0.125	WAT125-8250-750-E8D
	8	0.875	0.125	WAT125-8250-875-E8D
	8	1	0.125	WAT125-8250-1000-E8D
8	1.25	0.125	WAT125-8250-1250-E8D	
8	1.5	0.125	WAT125-8250-1500-E8D	
8	1.75	0.125	WAT125-8250-1750-E8D	
8	2	0.125	WAT125-8250-2000-E8D	
<b>8.5</b>	8.125	0.625	0.187	WAT187-8500-625-E8D
	8.125	0.75	0.187	WAT187-8500-750-E8D
	8.125	0.875	0.187	WAT187-8500-875-E8D
	8.125	1	0.187	WAT187-8500-1000-E8D
	8.125	1.25	0.187	WAT187-8500-1250-E8D
	8.125	1.5	0.187	WAT187-8500-1500-E8D
	8.125	1.75	0.187	WAT187-8500-1750-E8D
	8.125	2	0.187	WAT187-8500-2000-E8D
	8.25	0.625	0.125	WAT125-8500-625-E8D
	8.25	0.75	0.125	WAT125-8500-750-E8D
	8.25	0.875	0.125	WAT125-8500-875-E8D
	8.25	1	0.125	WAT125-8500-1000-E8D
8.25	1.25	0.125	WAT125-8500-1250-E8D	
8.25	1.5	0.125	WAT125-8500-1500-E8D	
8.25	1.75	0.125	WAT125-8500-1750-E8D	
8.25	2	0.125	WAT125-8500-2000-E8D	
<b>8.75</b>	8.375	0.625	0.187	WAT187-8750-625-E8D
	8.375	0.75	0.187	WAT187-8750-750-E8D
	8.375	0.875	0.187	WAT187-8750-875-E8D
	8.375	1	0.187	WAT187-8750-1000-E8D

Cylinder dimensions				Designation	
D	d	L	S		
in.				-	
<b>8.75</b> cont.	8.375	1.25	0.187	WAT187-8750-1250-E8D	
	8.375	1.5	0.187	WAT187-8750-1500-E8D	
	8.375	1.75	0.187	WAT187-8750-1750-E8D	
	8.375	2	0.187	WAT187-8750-2000-E8D	
<b>8.5</b>	8.5	0.625	0.125	WAT125-8750-625-E8D	
	8.5	0.75	0.125	WAT125-8750-750-E8D	
	8.5	0.875	0.125	WAT125-8750-875-E8D	
	8.5	1	0.125	WAT125-8750-1000-E8D	
	8.5	1.25	0.125	WAT125-8750-1250-E8D	
	8.5	1.5	0.125	WAT125-8750-1500-E8D	
	8.5	1.75	0.125	WAT125-8750-1750-E8D	
	8.5	2	0.125	WAT125-8750-2000-E8D	
	<b>9</b>	8.625	0.625	0.187	WAT187-9000-625-E8D
		8.625	0.75	0.187	WAT187-9000-750-E8D
		8.625	0.875	0.187	WAT187-9000-875-E8D
		8.625	1	0.187	WAT187-9000-1000-E8D
8.625		1.25	0.187	WAT187-9000-1250-E8D	
8.625		1.5	0.187	WAT187-9000-1500-E8D	
8.625		1.75	0.187	WAT187-9000-1750-E8D	
8.625		2	0.187	WAT187-9000-2000-E8D	
8.75		0.625	0.125	WAT125-9000-625-E8D	
8.75		0.75	0.125	WAT125-9000-750-E8D	
8.75		0.875	0.125	WAT125-9000-875-E8D	
8.75		1	0.125	WAT125-9000-1000-E8D	
8.75	1.25	0.125	WAT125-9000-1250-E8D		
8.75	1.5	0.125	WAT125-9000-1500-E8D		
8.75	1.75	0.125	WAT125-9000-1750-E8D		
8.75	2	0.125	WAT125-9000-2000-E8D		
<b>9.25</b>	8.875	0.75	0.187	WAT187-9250-750-E8D	
	8.875	0.875	0.187	WAT187-9250-875-E8D	
	8.875	1	0.187	WAT187-9250-1000-E8D	
	8.875	1.25	0.187	WAT187-9250-1250-E8D	
	8.875	1.5	0.187	WAT187-9250-1500-E8D	
	8.875	1.75	0.187	WAT187-9250-1750-E8D	
	8.875	2	0.187	WAT187-9250-2000-E8D	
	9	0.75	0.125	WAT125-9250-750-E8D	
	9	0.875	0.125	WAT125-9250-875-E8D	
	9	1	0.125	WAT125-9250-1000-E8D	
	9	1.25	0.125	WAT125-9250-1250-E8D	
	9	1.5	0.125	WAT125-9250-1500-E8D	
9	1.75	0.125	WAT125-9250-1750-E8D		
9	2	0.125	WAT125-9250-2000-E8D		
<b>9.5</b>	9.125	0.75	0.187	WAT187-9500-750-E8D	
	9.125	0.875	0.187	WAT187-9500-875-E8D	
	9.125	1	0.187	WAT187-9500-1000-E8D	
	9.125	1.25	0.187	WAT187-9500-1250-E8D	
	9.125	1.5	0.187	WAT187-9500-1500-E8D	
	9.125	1.75	0.187	WAT187-9500-1750-E8D	
	9.125	2	0.187	WAT187-9500-2000-E8D	
	9.25	0.75	0.125	WAT125-9500-750-E8D	
	9.25	0.875	0.125	WAT125-9500-875-E8D	
	9.25	1	0.125	WAT125-9500-1000-E8D	
	9.25	1.25	0.125	WAT125-9500-1250-E8D	
	9.25	1.5	0.125	WAT125-9500-1500-E8D	
9.25	1.75	0.125	WAT125-9500-1750-E8D		
9.25	2	0.125	WAT125-9500-2000-E8D		



## 5.2 WAT rod or piston guide rings, inch sizes

D 9.75 – 10.5 in.

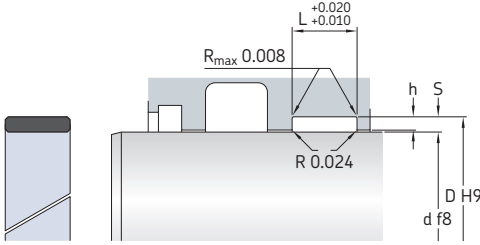

Rod application  
(dynamic on the inside surface)

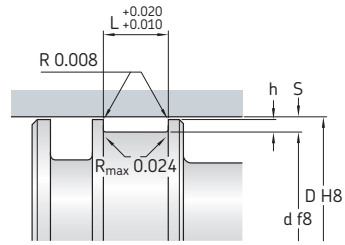

Piston application  
(dynamic on the outside surface)

$$h \geq S/2$$

Cylinder dimensions				Designation	
D	d	L	S		
in.				-	
9.75	9.375	0.75	0.187	WAT187-9750-750-E8D	
	9.375	0.875	0.187	WAT187-9750-875-E8D	
	9.375	1	0.187	WAT187-9750-1000-E8D	
	9.375	1.25	0.187	WAT187-9750-1250-E8D	
	9.375	1.5	0.187	WAT187-9750-1500-E8D	
	9.375	1.75	0.187	WAT187-9750-1750-E8D	
	9.375	2	0.187	WAT187-9750-2000-E8D	
	9.5	0.75	0.125	WAT125-9750-750-E8D	
	9.5	0.875	0.125	WAT125-9750-875-E8D	
	9.5	1	0.125	WAT125-9750-1000-E8D	
	9.5	1.25	0.125	WAT125-9750-1250-E8D	
	9.5	1.5	0.125	WAT125-9750-1500-E8D	
	9.5	1.75	0.125	WAT125-9750-1750-E8D	
	9.5	2	0.125	WAT125-9750-2000-E8D	
	10	9.625	0.75	0.187	WAT187-10000-750-E8D
		9.625	0.875	0.187	WAT187-10000-875-E8D
9.625		1	0.187	WAT187-10000-1000-E8D	
9.625		1.25	0.187	WAT187-10000-1250-E8D	
9.625		1.5	0.187	WAT187-10000-1500-E8D	
9.625		1.75	0.187	WAT187-10000-1750-E8D	
9.625		2	0.187	WAT187-10000-2000-E8D	
9.625		2.25	0.187	WAT187-10000-2250-E8D	
9.75		0.75	0.125	WAT125-10000-750-E8D	
9.75		0.875	0.125	WAT125-10000-875-E8D	
9.75		1	0.125	WAT125-10000-1000-E8D	
9.75		1.25	0.125	WAT125-10000-1250-E8D	
9.75		1.5	0.125	WAT125-10000-1500-E8D	
9.75		1.75	0.125	WAT125-10000-1750-E8D	
9.75		2	0.125	WAT125-10000-2000-E8D	
9.75		2.25	0.125	WAT125-10000-2250-E8D	

Cylinder dimensions				Designation
D	d	L	S	
in.				-
10.5	10.125	0.75	0.187	WAT187-10500-750-E8D
	10.125	0.875	0.187	WAT187-10500-875-E8D
	10.125	1	0.187	WAT187-10500-1000-E8D
	10.125	1.25	0.187	WAT187-10500-1250-E8D
	10.125	1.5	0.187	WAT187-10500-1500-E8D
	10.125	1.75	0.187	WAT187-10500-1750-E8D
	10.13	2	0.187	WAT187-10500-2000-E8D
	10.25	0.75	0.125	WAT125-10500-750-E8D
	10.25	0.875	0.125	WAT125-10500-875-E8D
	10.25	1	0.125	WAT125-10500-1000-E8D
	10.25	1.25	0.125	WAT125-10500-1250-E8D
	10.25	1.5	0.125	WAT125-10500-1500-E8D
	10.25	1.75	0.125	WAT125-10500-1750-E8D
	10.25	2	0.125	WAT125-10500-2000-E8D





### 5.3 RGR rod guide rings, metric sizes

d 12 – 140 mm

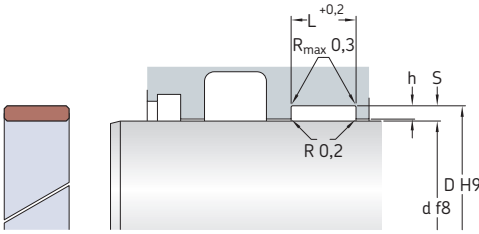

$$h \geq S/2$$

Cylinder dimensions				Designation
d	D	L	S	
mm				
12	15	6,3	1,5	RGR 12x15x6.3-PF
	15,1	4	1,55	RGR 12x15.1x4-PF
14	17,1	4	1,55	RGR 14x17.1x4-PF
15	18,1	4	1,55	RGR 15x18.1x4-PF
16	19	6	1,5	RGR 16x19x6-PF
	19	6	1,5	RGR 16x19x6-PF
	19,1	4	1,55	RGR 16x19.1x4-PF
	20	10	2	RGR 16x20x10-PF
18	21,1	4	1,55	RGR 18x21.1x4-PF
20	23	10	1,5	RGR 20x23x10-PF
	23,1	4	1,55	RGR 20x23.1x4-PF
	24	5,6	2	RGR 20x24x5.6-PF
22	25	10	1,5	RGR 22x25x10-PF
	25,1	4	1,55	RGR 22x25.1x4.0-PF
	25,1	4	1,55	RGR 22x25.1x4-PF
25	28	6	1,5	RGR 25x28x6-PF
	28	10	1,5	RGR 25x28x10-PF
	28	20	1,5	RGR 25x28x20-PF
	28,1	4	1,55	RGR 25x28.1x4-PF
	28,1	4,2	1,55	RGR 25x28.1x4.2-PF
	29	5,6	2	RGR 25x29x5.6-PF
	29	10	2	RGR 25x29x10-PF
	29	20	2	RGR 25x29x20-PF
30	5,6	2,5	RGR 25x30x5.6-PF	
31	10	3	RGR 25x31x10-PF	
28	31,1	4	1,55	RGR 28x31.1x4-PF
	32	10	2	RGR 28x32x10-PF
	33	5,6	2,5	RGR 28x33x5.6-PF
	34	10	3	RGR 28x34x10-PF

Cylinder dimensions				Designation
d	D	L	S	
mm				
30	33,1	4	1,55	RGR 30x33.1x4-PF
	34	10	2	RGR 30x34x10-PF
	35	5,6	2,5	RGR 30x35x5.6-PF
32	35	5,6	1,5	RGR 32x35x5.6-PF
	35,1	4,2	1,55	RGR 32x35.1x4.2-PF
	36	10	2	RGR 32x36x10-PF
	36	15	2	RGR 32x36x15-PF
	36	20	2	RGR 32x36x20-PF
37	37	5,6	2,5	RGR 32x37x5.6-PF
	37	9,7	2,5	RGR 32x37x9.7-PF
	38	10	3	RGR 32x38x10-PF
35	38	10	1,5	RGR 35x38x10-PF
	39	20	2	RGR 35x39x20-PF
	40	5,6	2,5	RGR 35x40x5.6-PF
	40	9,7	2,5	RGR 35x40x9.7-PF
	41	10	3	RGR 35x41x10-PF
36	40	10	2	RGR 36x40x10-PF
	40	30	2	RGR 36x40x30-PF
	41	5,6	2,5	RGR 36x41x5.6-PF
	41	9,7	2,5	RGR 36x41x9.7-PF
	42	10	3	RGR 36x42x10-PF
40	43	5,6	1,5	RGR 40x43x5.6-PF
	44	10	2	RGR 40x44x10-PF
	44	20	2	RGR 40x44x20-PF
	44	25	2	RGR 40x44x25-PF
	45	5,6	2,5	RGR 40x45x5.6-PF
	45	9,7	2,5	RGR 40x45x9.7-PF
	46	10	3	RGR 40x46x10-PF
	46	15	3	RGR 40x46x15-PF
46	20	3	RGR 40x46x20-PF	
46	25	3	RGR 40x46x25-PF	

Cylinder dimensions				Designation
d	D	L	S	
mm				-
45	49	15	2	RGR 45x49x15-PF
	50	5,6	2,5	RGR 45x50x5.6-PF
	50	9,7	2,5	RGR 45x50x9.7-PF
	51	13	3	RGR 45x51x13-PF
	51	20	3	RGR 45x51x20-PF
	51	40	3	RGR 45x51x40-PF
50	55	5,6	2,5	RGR 50x55x5.6-PF
	55	9,7	2,5	RGR 50x55x9.7-PF
	55	15	2,5	RGR 50x55x15-PF
	56	13	3	RGR 50x56x13-PF
	56	20	3	RGR 50x56x20-PF
	56	30	3	RGR 50x56x30-PF
55	60	5,6	2,5	RGR 55x60x5.6-PF
	60	9,7	2,5	RGR 55x60x9.7-PF
56	61	5,6	2,5	RGR 56x61x5.6-PF
	61	9,7	2,5	RGR 56x61x9.7-PF
	62	13	3	RGR 56x62x13-PF
	62	16	3	RGR 56x62x16-PF
	62	30	3	RGR 56x62x30-PF
	62	40	3	RGR 56x62x40-PF
60	65	5,6	2,5	RGR 60x65x5.6-PF
	65	9,7	2,5	RGR 60x65x9.7-PF
	65	15	2,5	RGR 60x65x15-PF
	66	13	3	RGR 60x66x13-PF
	66	20	3	RGR 60x66x20-PF
	66	30	3	RGR 60x66x30-PF
63	68	5,6	2,5	RGR 63x68x5.6-PF
	68	9,7	2,5	RGR 63x68x9.7-PF
	68	15	2,5	RGR 63x68x15-PF
	69	13	3	RGR 63x69x13-PF
	69	20	3	RGR 63x69x20-PF
	69	30	3	RGR 63x69x30-PF
65	70	9,7	2,5	RGR 65x70x9.7-PF
	71	13	3	RGR 65x71x13-PF
	71	20	3	RGR 65x71x20-PF
	71	40	3	RGR 65x71x40-PF
70	75	9,7	2,5	RGR 70x75x9.7-PF
	76	13	3	RGR 70x76x13-PF
	76	20	3	RGR 70x76x20-PF
	76	30	3	RGR 70x76x30-PF
	76	40	3	RGR 70x76x40-PF
	76	50	3	RGR 70x76x50-PF
75	80	9,7	2,5	RGR 75x80x9.7-PF
	81	13	3	RGR 75x81x13-PF
	81	20	3	RGR 75x81x20-PF
	81	30	3	RGR 75x81x30-PF
	81	60	3	RGR 75x81x60-PF
80	85	9,7	2,5	RGR 80x85x9.7-PF
	85	15	2,5	RGR 80x85x15-PF
	86	13	3	RGR 80x86x13-PF
	86	20	3	RGR 80x86x20-PF
		86	25	3
	86	30	3	RGR 80x86x30-PF
	86	40	3	RGR 80x86x40-PF
	86	50	3	RGR 80x86x50-PF

Cylinder dimensions				Designation
d	D	L	S	
mm				-
85	90	9,7	2,5	RGR 85x90x9.7-PF
	90	15	2,5	RGR 85x90x15-PF
	91	13	3	RGR 85x91x13-PF
	91	20	3	RGR 85x91x20-PF
	91	25	3	RGR 85x91x25-PF
90	95	9,7	2,5	RGR 90x95x9.7-PF
	95	15	2,5	RGR 90x95x15-PF
	96	13	3	RGR 90x96x13-PF
	96	20	3	RGR 90x96x20-PF
	96	30	3	RGR 90x96x30-PF
	96	40	3	RGR 90x96x40-PF
95	100	9,7	2,5	RGR 95x100x9.7-PF
	100	15	2,5	RGR 95x100x15-PF
100	105	9,7	2,5	RGR 100x105x9.7-PF
	105	15	2,5	RGR 100x105x15-PF
	106	13	3	RGR 100x106x13-PF
	106	20	3	RGR 100x106x20-PF
	106	25	3	RGR 100x106x25-PF
	106	30	3	RGR 100x106x30-PF
	106	40	3	RGR 100x106x40-PF
	106	50	3	RGR 100x106x50-PF
105	111	20	3	RGR 105x111x20-PF
110	115	9,7	2,5	RGR 110x115x9.7-PF
	115	15	2,5	RGR 110x115x15-PF
	116	13	3	RGR 110x116x13-PF
	116	20	3	RGR 110x116x20-PF
	116	30	3	RGR 110x116x30-PF
115	121	20	3	RGR 115x121x20-PF
120	125	9,7	2,5	RGR 120x125x9.7-PF
	125	15	2,5	RGR 120x125x15-PF
	126	40	3	RGR 120x126x40-PF
	126	50	3	RGR 120x126x50-PF
125	130	9,7	2,5	RGR 125x130x9.7-PF
	130	15	2,5	RGR 125x130x15-PF
	131	13	3	RGR 125x131x13-PF
	131	30	3	RGR 125x131x30-PF
	131	40	3	RGR 125x131x40-PF
	131	50	3	RGR 125x131x50-PF
	133	20	4	RGR 125x133x20-PF
	133	30	4	RGR 125x133x30-PF
	133	45	4	RGR 125x133x45-PF
	133	60	4	RGR 125x133x60-PF
127	133	13	3	RGR 127x133x13-PF
130	135	9,7	2,5	RGR 130x135x9.7-PF
	135	15	2,5	RGR 130x135x15-PF
135	141	90	3	RGR 135x141x90-PF
140	145	9,7	2,5	RGR 140x145x9.7-PF
	145	15	2,5	RGR 140x145x15-PF
	146	13	3	RGR 140x146x13-PF
	146	20	3	RGR 140x146x20-PF
	146	25	3	RGR 140x146x25-PF
	146	40	3	RGR 140x146x40-PF
	148	20	4	RGR 140x148x20-PF



## 5.3 RGR rod guide rings, metric sizes

d 150 – 365 mm

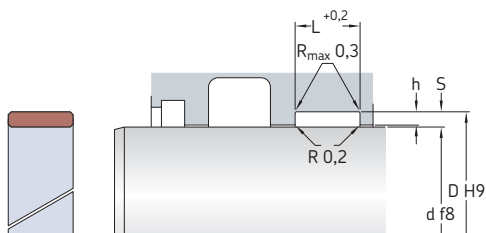

$$h \geq S/2$$

Cylinder dimensions				Designation
d	D	L	S	
mm				-
150	155	9,7	2,5	RGR 150x155x9.7-PF
	155	15	2,5	RGR 150x155x15-PF
	156	19,5	3	RGR 150x156x19.5-PF
	156	30	3	RGR 150x156x30-PF
	158	20	4	RGR 150x158x20-PF
160	165	9,7	2,5	RGR 160x165x9.7-PF
	165	15	2,5	RGR 160x165x15-PF
	166	30	3	RGR 160x166x30-PF
	168	30	4	RGR 160x168x30-PF
	168	40	4	RGR 160x168x40-PF
180	185	9,7	2,5	RGR 180x185x9.7-PF
	185	15	2,5	RGR 180x185x15-PF
	186	19,5	3	RGR 180x186x19.5-PF
195	203	25	4	RGR 195x203x25-PF
200	205	15	2,5	RGR 200x205x15-PF
	205	25	2,5	RGR 200x205x25-PF
210	218	25	4	RGR 210x218x25-PF
220	225	15	2,5	RGR 220x225x15-PF
	225	25	2,5	RGR 220x225x25-PF
	228	25	4	RGR 220x228x25-PF
235	243	30	4	RGR 235x243x30-PF
250	255	15	2,5	RGR 250x255x15-PF
	255	25	2,5	RGR 250x255x25-PF
255	263	25	4	RGR 255x263x25-PF
264	272	24	4	RGR 264x272x24-PF
305	313	25	4	RGR 305x313x25-PF
365	373	35	4	RGR 365x373x35-PF



## 5.4 PGR piston guide rings, metric sizes

D 16 – 240 mm

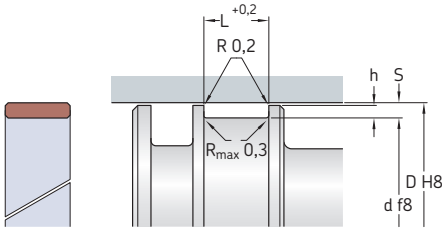

$$h \geq S/2$$

Cylinder dimensions				Designation
D	d	L	S	
mm				
16	11	5,6	2,5	PGR 16x11x5.6-PF
	12,9	4	1,55	PGR 16x12.9x4-PF
18	13	5,6	2,5	PGR 18x13x5.6-PF
	14,9	4	1,55	PGR 18x14.9x4-PF
20	15	5,6	2,5	PGR 20x15x5.6-PF
	16,9	4	1,55	PGR 20x16.9x4-PF
25	20	5,6	2,5	PGR 25x20x5.6-PF
	20	5,6	2,5	PGR 25x20x5.6-PF
	21,9	4	1,55	PGR 25x21.9x4-PF
30	24	10	3	PGR 30x24x10-PF
	25	5,6	2,5	PGR 30x25x5.6-PF
	26,9	4	1,55	PGR 30x26.9x4-PF
32	27	5,6	2,5	PGR 32x27x5.6-PF
	28,9	4	1,55	PGR 32x28.9x4-PF
35	30	5,6	2,5	PGR 35x30x5.6-PF
	31,9	4	1,55	PGR 35x31.9x4-PF
40	34	10	3	PGR 40x34x10-PF
	35	5,6	2,5	PGR 40x35x5.6-PF
	35	9,7	2,5	PGR 40x35x9.7-PF
	36	10	2	PGR 40x36x10-PF
	36,9	4	1,55	PGR 40x36.9x4-PF
45	39	10	3	PGR 45x39x10-PF
	40	5,6	2,5	PGR 45x40x5.6-PF
	41	12	2	PGR 45x41x12-PF
	41,9	4	1,55	PGR 45x41.9x4-PF
50	44	10	3	PGR 50x44x10-PF
	45	5,6	2,5	PGR 50x45x5.6-PF
	45	6,3	2,5	PGR 50x45x6.3-PF
	45	9,7	2,5	PGR 50x45x9.7-PF
	46	12	2	PGR 50x46x12-PF
	46,9	4	1,55	PGR 50x46.9x4-PF

Cylinder dimensions				Designation
D	d	L	S	
mm				
55	50	4	2,5	PGR 55x50x4-PF
	50	5,6	2,5	PGR 55x50x5.6-PF
	50	9,7	2,5	PGR 55x50x9.7-PF
	50	25	2,5	PGR 55x50x25-PF
60	54	10	3	PGR 60x54x10-PF
	54	13	3	PGR 60x54x13-PF
	54	20	3	PGR 60x54x20-PF
	54	30	3	PGR 60x54x30-PF
55	55	5,6	2,5	PGR 60x55x5.6-PF
	55	6,3	2,5	PGR 60x55x6.3-PF
	55	9,7	2,5	PGR 60x55x9.7-PF
63	57	13	3	PGR 63x57x13-PF
	57	20	3	PGR 63x57x20-PF
	58	5,6	2,5	PGR 63x58x5.6-PF
	58	6,3	2,5	PGR 63x58x6.3-PF
	58	9,7	2,5	PGR 63x58x9.7-PF
	58	10	2,5	PGR 63x58x10-PF
65	59	13	3	PGR 65x59x13-PF
	59	20	3	PGR 65x59x20-PF
	60	5,6	2,5	PGR 65x60x5.6-PF
	60	9,7	2,5	PGR 65x60x9.7-PF
70	64	13	3	PGR 70x64x13-PF
	64	20	3	PGR 70x64x20-PF
	65	5,6	2,5	PGR 70x65x5.6-PF
	65	9,7	2,5	PGR 70x65x9.7-PF
	65	20	2,5	PGR 70x65x20-PF
75	70	5,6	2,5	PGR 75x70x5.6-PF
	70	9,7	2,5	PGR 75x70x9.7-PF

Cylinder dimensions				Designation
D	d	L	S	
mm				-
80	72	12	4	PGR 80x72x12-PF
	74	13	3	PGR 80x74x13-PF
	74	20	3	PGR 80x74x20-PF
	74	25	3	PGR 80x74x25-PF
	75	5,6	2,5	PGR 80x75x5.6-PF
75	9,7	2,5	PGR 80x75x9.7-PF	
75	15	2,5	PGR 80x75x15-PF	
85	79	30	3	PGR 85x79x30-PF
	80	5,6	2,5	PGR 85x80x5.6-PF
	80	9,7	2,5	PGR 85x80x9.7-PF
90	84	13	3	PGR 90x84x13-PF
	84	20	3	PGR 90x84x20-PF
	85	5,6	2,5	PGR 90x85x5.6-PF
	85	9,7	2,5	PGR 90x85x9.7-PF
95	89	13	3	PGR 95x89x13-PF
	90	9,7	2,5	PGR 95x90x9.7-PF
100	94	13	3	PGR 100x94x13-PF
	94	20	3	PGR 100x94x20-PF
	94	25	3	PGR 100x94x25-PF
	94	30	3	PGR 100x94x30-PF
	95	9,7	2,5	PGR 100x95x9.7-PF
110	104	13	3	PGR 110x104x13-PF
	104	20	3	PGR 110x104x20-PF
	104	30	3	PGR 110x104x30-PF
	105	9,7	2,5	PGR 110x105x9.7-PF
	105	15	2,5	PGR 110x105x15-PF
115	109	13	3	PGR 115x109x13-PF
	110	9,7	2,5	PGR 115x110x9.7-PF
120	114	13	3	PGR 120x114x13-PF
	114	20	3	PGR 120x114x20-PF
	114	30	3	PGR 120x114x30-PF
	114	40	3	PGR 120x114x40-PF
	115	9,7	2,5	PGR 120x115x9.7-PF
125	119	13	3	PGR 125x119x13-PF
	119	15	3	PGR 125x119x15-PF
	119	20	3	PGR 125x119x20-PF
	119	25	3	PGR 125x119x25-PF
	119	30	3	PGR 125x119x30-PF
	120	9,7	2,5	PGR 125x120x9.7-PF
130	124	13	3	PGR 130x124x13-PF
	124	30	3	PGR 130x124x30-PF
	125	9,7	2,5	PGR 130x125x9.7-PF
135	129	13	3	PGR 135x129x13-PF
140	134	13	3	PGR 140x134x13-PF
	134	20	3	PGR 140x134x20-PF
	134	25	3	PGR 140x134x25-PF
	134	30	3	PGR 140x134x30-PF
	135	9,7	2,5	PGR 140x135x9.7-PF
135	15	2,5	PGR 140x135x15-PF	
145	139	30	3	PGR 145x139x30-PF

Cylinder dimensions				Designation
D	d	L	S	
mm				-
150	144	13	3	PGR 150x144x13-PF
	144	20	3	PGR 150x144x20-PF
	144	30	3	PGR 150x144x30-PF
	144	40	3	PGR 150x144x40-PF
	145	9,7	2,5	PGR 150x145x9.7-PF
	145	15	2,5	PGR 150x145x15-PF
	155	149	13	3
160	154	13	3	PGR 160x154x13-PF
	154	15	3	PGR 160x154x15-PF
	154	19,5	3	PGR 160x154x19.5-PF
	154	30	3	PGR 160x154x30-PF
	154	35	3	PGR 160x154x35-PF
	154	50	3	PGR 160x154x50-PF
155	155	9,7	2,5	PGR 160x155x9.7-PF
	155	15	2,5	PGR 160x155x15-PF
170	160	20	5	PGR 170x160x20-PF
	164	19,5	3	PGR 170x164x19.5-PF
	164	20	3	PGR 170x164x20-PF
	164	30	3	PGR 170x164x30-PF
	165	9,7	2,5	PGR 170x165x9.7-PF
	165	15	2,5	PGR 170x165x15-PF
180	172	40	4	PGR 180x172x40-PF
	174	13	3	PGR 180x174x13-PF
	174	19,5	3	PGR 180x174x19.5-PF
	174	30	3	PGR 180x174x30-PF
	175	9,7	2,5	PGR 180x175x9.7-PF
	175	15	2,5	PGR 180x175x15-PF
190	184	25	3	PGR 190x184x25-PF
	184	30	3	PGR 190x184x30-PF
	185	9,7	2,5	PGR 190x185x9.7-PF
	185	15	2,5	PGR 190x185x15-PF
200	192	25	4	PGR 200x192x25-PF
	194	20	3	PGR 200x194x20-PF
	194	30	3	PGR 200x194x30-PF
	194	50	3	PGR 200x194x50-PF
	195	9,7	2,5	PGR 200x195x9.7-PF
200	195	15	2,5	PGR 200x195x15-PF
	195	20	2,5	PGR 200x195x20-PF
	205	9,7	2,5	PGR 210x205x9.7-PF
210	205	15	2,5	PGR 210x205x15-PF
	212	20	4	PGR 220x212x20-PF
220	212	30	4	PGR 220x212x30-PF
	214	19,5	3	PGR 220x214x19.5-PF
	214	30	3	PGR 220x214x30-PF
	215	9,7	2,5	PGR 220x215x9.7-PF
	215	15	2,5	PGR 220x215x15-PF
	215	15	2,5	PGR 220x215x15-PF
230	225	15	2,5	PGR 230x225x15-PF
240	232	25	4	PGR 240x232x25-PF
	232	40	4	PGR 240x232x40-PF
	235	9,7	2,5	PGR 240x235x9.7-PF
	235	15	2,5	PGR 240x235x15-PF
	235	15	2,5	PGR 240x235x15-PF



## 5.4 PGR piston guide rings, metric sizes

D 250 – 400 mm

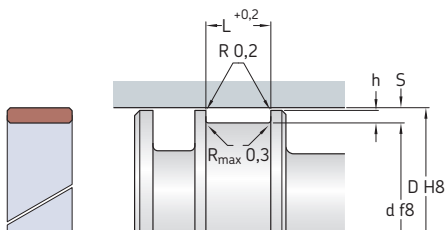

$$h \geq S/2$$

Cylinder dimensions				Designation
D	d	L	S	
mm				-
250	242	20	4	PGR 250x242x20-PF
	242	25	4	PGR 250x242x25-PF
	242	40	4	PGR 250x242x40-PF
	244	19,5	3	PGR 250x244x19.5-PF
	244	50	3	PGR 250x244x50-PF
245	9,7	2,5		PGR 250x245x9.7-PF
	15	2,5		PGR 250x245x15-PF
260	255	9,7	2,5	PGR 260x255x9.7-PF
	255	15	2,5	PGR 260x255x15-PF
270	262	25	4	PGR 270x262x25-PF
	262	30	4	PGR 270x262x30-PF
280	272	25	4	PGR 280x272x25-PF
	275	15	2,5	PGR 280x275x15-PF
	275	25	2,5	PGR 280x275x25-PF
300	292	20	4	PGR 300x292x20-PF
	292	25	4	PGR 300x292x25-PF
	292	40	4	PGR 300x292x40-PF
	295	15	2,5	PGR 300x295x15-PF
	295	25	2,5	PGR 300x295x25-PF
400	392	30	4	PGR 400x392x30-PF





# More guide rings

### Spark rings

Spark rings (also known as contamination rings, → **fig. 9**) are not technically guide rings, as they are not intended to accommodate radial loads. They rather protect the guides and piston seals from damage due to contamination particles or combustion of gases in the fluid media (diesel effect). SKF supplies spark rings in a variety of PTFE materials.

### Customized machined guide profiles

SKF can manufacture a wide variety of guide profiles (→ **fig. 10**) with different materials and customized sizes with its industry-leading SKF SEAL JET production system. SKF can supply tailor-made machined guide rings in close partnership with customers from the design phase to serial production.

For additional information about customized machined profiles, contact SKF.

Fig. 9

Guide rings combined with spark rings

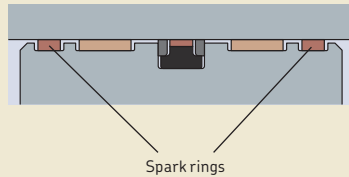
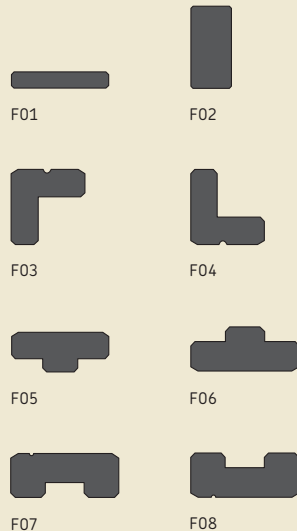
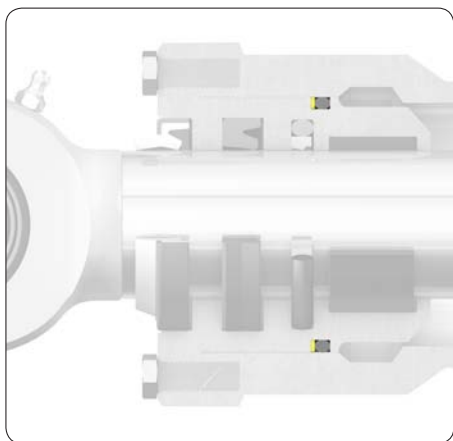
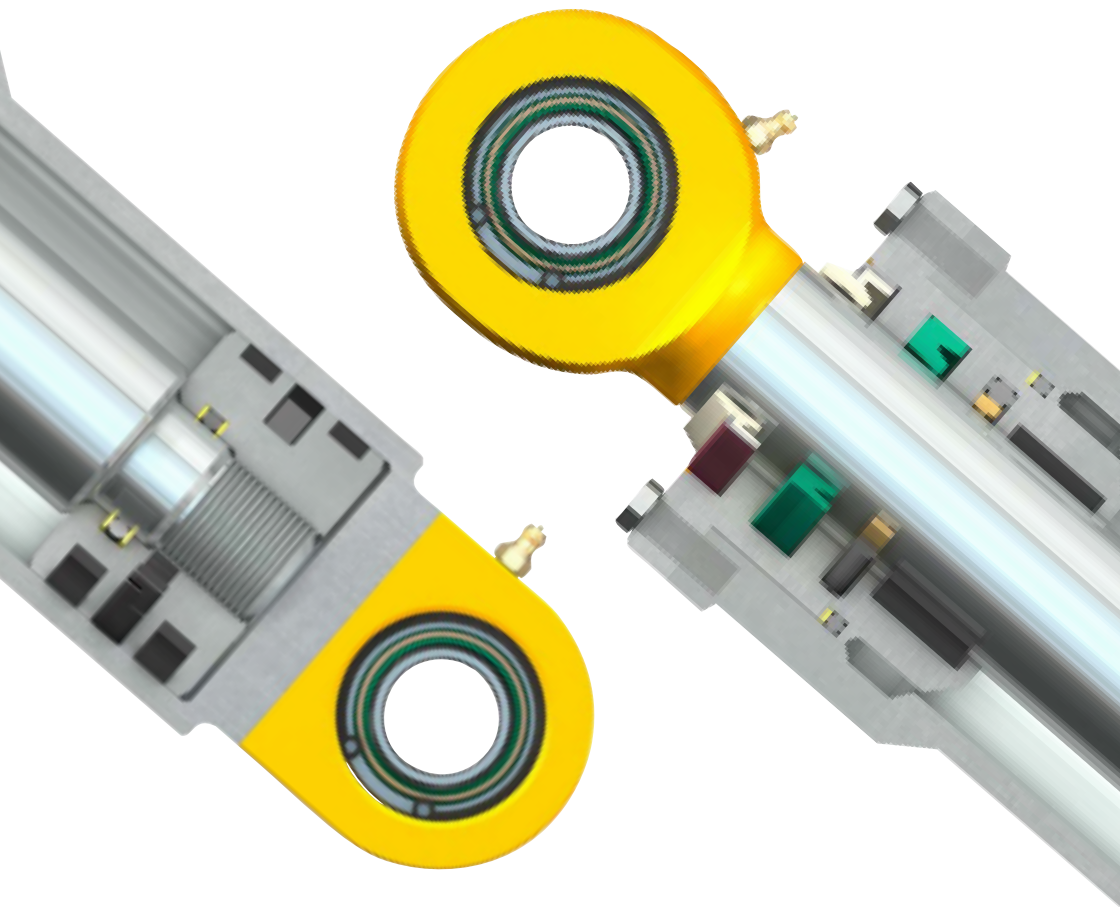

Fig. 10

Examples of SKF SEAL JET guide profiles







# O-rings and back-up rings

<b>Basics</b> . . . . .	<b>292</b>	<b>Profile data</b>	
Designations . . . . .	292	<b>6.1</b> OR O-rings in static radial sealing, metric sizes . . . . .	300
Materials . . . . .	292	<b>6.2</b> OR O-rings in static radial sealing, inch sizes . . . . .	316
<b>Standards and sizes</b> . . . . .	<b>294</b>	<b>6.3</b> STR Back-up rings in static radial sealing, metric sizes by dash number . . . . .	324
Dimension standards . . . . .	294	<b>6.4</b> STR Back-up rings in static radial sealing, metric sizes . . . . .	334
Inside/cross section diameter proportion . . . . .	294	<b>6.5</b> STR Back-up rings in static radial sealing, inch sizes . . . . .	338
Tolerance standard . . . . .	294	<b>Other O-ring sealing and ring materials</b> . . . . .	<b>344</b>
Surface standard . . . . .	295	Dynamic radial sealing . . . . .	344
<b>Housing design and dimensions</b> . . . . .	<b>297</b>	Static axial sealing . . . . .	344
Housing dimensions for static radial sealing . . . . .	297	PTFE encapsulated O-rings . . . . .	345
Groove edges . . . . .	297	Back-up rings made of polyester thermoplastic elastomer . . . . .	345
Lead-in chamfers . . . . .	297	Back-up rings made of PTFE . . . . .	345
Extrusion gaps and back-up rings . . . . .	298		
Groove width . . . . .	299		

## Basics

O-rings are one of the most common sealing solutions. SKF supplies O-rings in a wide range of sizes and different materials, which make them appropriate for a wide variety of operating conditions and applications. They are easy to install and they enable a simple and economic seal housing design.

O-rings maintain sealing contact force by radial or axial deformation in the seal housing between two machine components. The most important criteria that influence the maximum operating pressure at which O-rings in static radial sealing can be used are the following:

- extrusion gap (→ **fig. 2, page 298**)
- material (→ *Materials*)
- sealed fluid
- temperature

Under specific conditions, there is a risk for gap extrusion (→ *Extrusion gaps and back-up rings, page 298*). Back-up rings prevent O-rings from gap extrusion in static radial sealing.

O-rings are used in a wide variety of applications sealing various media. This catalogue focuses on sealing systems for hydraulic cylinders. Therefore, this chapter and provided recommendations apply to static sealing common mineral-based hydraulic fluids (→ *Hydraulic fluids, page 31*).

## Designations

For consistency, the designations of SKF O-rings (→ **table 1**) and back-up rings (→ **table 2**) consist of their dimensions in metric units. However, the product tables for both rings are provided in inch and metric sizes. If applicable, the unique dash-numbers for O-ring sizes in accordance with standards AS 586 and ISO 3601 are also listed.

## Materials

The O-rings listed in this catalogue are made of nitrile rubber (NBR) with 70 Shore A (shA) hardness as standard. This is the most common O-ring material and hardness used in hydraulic cylinder applications. On request, SKF can supply alternative hardnesses such as 80 shA or 90 shA. However, SKF generally recommends choosing O-rings with 70 shA and combining them with one or two back-up rings (→ *Extrusion gaps and back-up rings, page 298*). At operating temperatures above 100 °C (210 °F), fluorocarbon rubber or HNBR rubber can be an appropriate material, depending on the fluid.

SKF back-up rings listed in this catalogue are made of polyurethane (TPU). On request, SKF can supply alternative materials and hardness. Common back-up ring materials are listed in the designation system (→ **table 2**).

For additional information about O-ring and back-up ring materials, refer to *Materials* (→ **page 26**).

### More information

Counter-surface finish properties . . .	22
Materials . . . . .	26
Hydraulic fluids . . . . .	31
Gap extrusion . . . . .	34
Storage . . . . .	36
Installation and assembly . . . . .	38

Table 1

Designation system for SKF O-rings

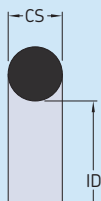

**OR 99.1×5.7-N70**

- O-ring
- Inside diameter ID [mm]
- Cross section diameter CS [mm]
- Material code (→ table 5, page 29)

Table 2

Designation system for SKF back-up rings

Metric sizes

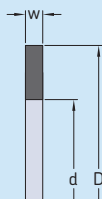

**STR 90×100×1.7-Y95A**

- Back-up ring
- Inside diameter d [mm]
- Outside diameter D [mm]
- Width w [mm]
- Material code\*)

Inch sizes with a dash number

**STR 19-342-395A**

- Back-up ring dash number series
- Dash number
- Material code\*)

\*) **Material codes**  
**Y95A** Polyurethane 95 Shore A (yellow)  
**395A** Polyurethane 98 Shore A (black)  
**HY** Polyester elastomer 95 Shore A (yellow)  
**100** Unfilled PTFE

## O-rings and back-up rings

# Standards and sizes

### Dimension standards

SKF can supply O-rings in a wide variety of sizes in accordance with various O ring standards. **Table 3** provides the most common national and international O-ring standards and their relevant sizes.

### Inside/cross section diameter proportion

O-rings used in more demanding applications, such as higher operating pressures or larger misalignments, may require larger cross section diameters. SKF recommends proportions

between inside diameter ID and cross section diameter CS as provided in **diagram 1**.

### Tolerance standard

SKF supplies all O-rings with dimensional tolerances in accordance with ISO 3601-1. The tolerance values are listed in **table 4**. They are suitable for any elastomer material provided that appropriate tooling is used, whereas the tooling most commonly used is based upon the shrinkage of nitrile rubber with 70 shA hardness.

Diagram 1

#### O-ring inside/cross section diameter proportion

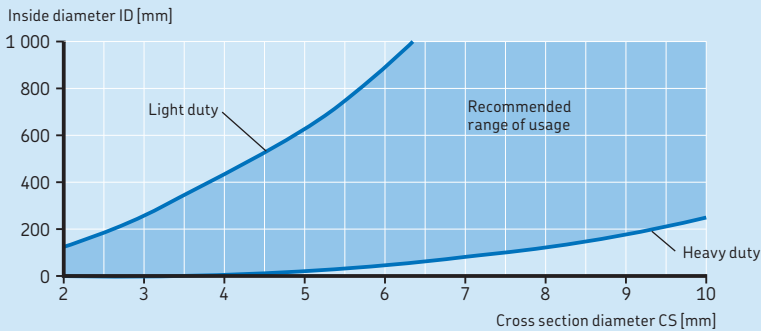

#### O-ring standards and relevant sizes

##### Standard

##### DIN 3771, ISO 3601

Cross section diameter CS	Inside diameter	
	ID <sub>min</sub>	ID <sub>max</sub>
mm	mm	
1,8	1,8	17
2,65	14	38,7
3,55	18	200
5,3	40	400
7	206	670

##### AS 568A

Cross section diameter CS	Inside diameter	
	ID <sub>min</sub>	ID <sub>max</sub>
mm	mm	
1,78	1,78	133,07
2,62	1,24	247,32
3,53	4,34	456,06
5,33	10,46	658,88
6,99	113,67	658,88

##### BS 4518

Cross section diameter CS	Inside diameter	
	ID <sub>min</sub>	ID <sub>max</sub>
mm	mm	
1,6	3,1	37,1
2,4	3,6	69,6
3	19,5	249,5
5,7	44,3	499,3
8,4	144,1	249,1

##### JIS 240 P+G

Cross section diameter CS	Inside diameter	
	ID <sub>min</sub>	ID <sub>max</sub>
mm	mm	
1,9	2,8	9,8
2,4	9,8	21,8
3,1	24,4	144,4
3,5	21,7	49,7
5,7	47,6	299,3
8,4	149,5	399,5



## Surface standard

SKF supplies O-rings that all have surfaces in accordance with ISO 3601-3 (→ **table 5, page 296**). This standard provides maximum acceptable imperfections and quality criteria for O-ring surfaces.

Table 4

### Tolerances

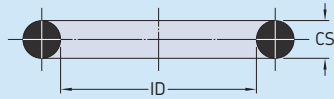

#### Inside diameter

ID		Tolerance
over	incl.	
mm		mm
<b>1,15</b>	6,3	± 0,15
<b>6,35</b>	10	± 0,17
<b>10,1</b>	16	± 0,2
<b>16,1</b>	25,07	± 0,25
<b>25,1</b>	33,5	± 0,32
<b>34</b>	42,86	± 0,4
<b>43</b>	54,6	± 0,5
<b>55</b>	67,3	± 0,6
<b>67,6</b>	87,5	± 0,75
<b>88</b>	107,67	± 0,9
<b>108</b>	136,53	± 1,1
<b>137</b>	165	± 1,3
<b>166</b>	194,5	± 1,5
<b>195</b>	236	± 1,8
<b>237</b>	285	± 2,1
<b>286</b>	345	± 2,5
<b>346</b>	429	± 3
<b>430</b>	540	± 3,7
<b>545</b>	670	± 4,5

#### Cross section diameter

CS		Tolerance
over	incl.	
mm		mm
<b>1</b>	2,4	± 0,08
<b>2,62</b>	2,65	± 0,09
<b>3</b>	3,55	± 0,1
<b>4</b>	5,7	± 0,13
<b>6</b>	8,4	± 0,15

Table 3

### SMS 1586

Cross section diameter CS	Inside diameter	
	ID <sub>min</sub>	ID <sub>max</sub>
mm	mm	
<b>1,6</b>	3,1	37,1
<b>2,4</b>	3,3	17,3
<b>3</b>	19,2	44,2
<b>5,7</b>	44,2	144,3
<b>8,4</b>	144,1	249,1

Table 5

Maximum acceptable surface imperfections

Surface imperfection category Schematic illustration	Letter symbol	Maximum acceptable limits Grade N O-rings					Grade S O-rings				
		Cross section diameter CS					Cross section diameter CS				
		>0,8	>2,25	>3,15	>4,50	>6,30	>0,8	>2,25	>3,15	>4,50	>6,30
		≤2,25	≤3,15	≤4,50	≤6,30	≤8,40	≤2,25	≤3,15	≤4,50	≤6,30	≤8,40
-		mm					mm				

Offset (off register and mismatch)

	e	0,08	0,1	0,13	0,15	0,15	0,08	0,08	0,1	0,12	0,13
---	---	------	-----	------	------	------	------	------	-----	------	------

Combined flash, offset and parting line projection

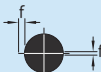
	f	0,1	0,12	0,14	0,16	0,18	0,1	0,1	0,13	0,15	0,15
---	---	-----	------	------	------	------	-----	-----	------	------	------

Backrind

	g	0,18	0,27	0,36	0,53	0,7	0,1	0,15	0,2	0,2	0,3
	h	0,08	0,08	0,1	0,1	0,13	0,05	0,08	0,1	0,1	0,13

Excessive trimming

	-	Departure from a circular cross section due to trimming is allowed provided that the resultant surface is smoothly blended and is within the size tolerance limits for CS.									
---	---	--	--	--	--	--	--	--	--	--	--

Flow marks (radial orientation of flow marks is not permissible)

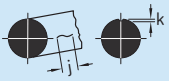
	j	1,5 <sup>1)</sup>	1,5 <sup>1)</sup>	6,5 <sup>1)</sup>	6,5 <sup>1)</sup>	6,5 <sup>1)</sup>	1,5 <sup>1)</sup>	1,5 <sup>1)</sup>	5 <sup>1)</sup>	5 <sup>1)</sup>	5 <sup>1)</sup>
	k	0,08	0,08	0,08	0,08	0,08	0,05	0,05	0,05	0,05	0,05

Non-fills and indentations (including parting line indentation)

	l	0,6	0,8	1	1,3	1,7	0,15	0,25	0,4	0,63	1
	m	0,08	0,08	0,1	0,1	0,13	0,08	0,08	0,1	0,1	0,13

Foreign material

-	Not permitted						Not permitted				
---	---------------	--	--	--	--	--	---------------	--	--	--	--

<sup>1)</sup> Or 0,05 x ID (O-ring inside diameter), whichever is greater

# Housing design and dimensions

## Housing dimensions for static radial sealing

O-rings for static (non-moving) sealing can be used in a wide variety of applications and arrangements. The most common arrangement in hydraulic cylinder applications is static radial sealing between coaxial cylindrical parts. The O-ring is installed in a groove that is machined either as an outside or inside groove (→ **fig. 1**) in one of the two cylindrical parts.

The housing dimensions for static radial sealing O-rings are listed in the product tables.

### Groove edges

All groove edges should be smoothed and rounded off to  $r = 0,1$  to  $0,2$  mm ( $0,004$  to  $0,008$  in.).

### Lead-in chamfers

All edges and openings through which the O-ring has to pass during the assembly should have appropriate lead-in chamfers and should be well rounded off (→ **table 6**). The chamfers facilitate assembly and protect the O-ring from damage during the mounting process. The O-ring and all surrounding parts should be well lubricated before assembly, preferably with the same fluid as used in the hydraulic system, ensuring compatibility with seals and cylinder components.

Fig. 1

### Static radial sealing arrangements

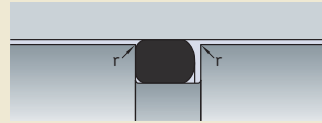

Outside groove

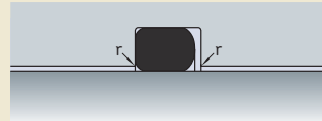

Inside groove

Table 6

### Lead-in chamfers for O-rings

#### Inside chamfer

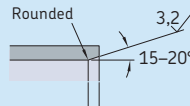

#### Outside chamfer

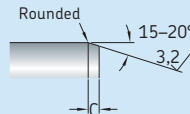

#### Hole

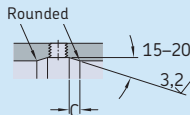

Cross section diameter		Chamfer length
CS	incl.	C
from		min.
mm		mm
1	1,5	1,5
1,6	2	2
2,4	3	2,5
3,53	4,5	3,5
5	5,7	4,5
6	8,4	5,5

## O-rings and back-up rings

### Extrusion gaps and back-up rings

The size of the permissible extrusion gap (→ *Gap extrusion*, page 34) depends mainly on the seal material, temperature and operating pressure. Harder materials (→ *Materials*, page 26) provide a certain resistance to gap extrusion. When the permissible extrusion gap for the pressure and temperature in application is exceeded, back-up rings may be used to prevent the seal pressing into the gap and causing extrusion damage and possibly even premature failure. **Figure 2** shows the O-ring behaviour at different operating pressures and conditions. In applications where the O-ring is exposed to pressure from one side only, the back-up ring is installed at the zero pressure side. For an O-ring exposed to pres-

sure from both sides, a back-up ring is installed on both sides.

For the extrusion gaps, SKF recommends a fit machined to tolerance classes f7(E) and H8(E).

**Diagrams 2 to 4** provide guideline values for the maximum extrusion gap in relation to the operating pressure for standard O-rings without back-up ring (→ **diagram 2**) and different back-up ring materials and ring sizes (→ **diagrams 3 and 4**). These guideline values are based on extensive tests conducted in SKF laboratories at 90 °C (195 °F) and 100 000 pressure pulses. However, other factors such as temperature and fluid can influence these guideline values and should be considered.

Fig. 2

#### O-ring behaviour at different operating pressures and conditions

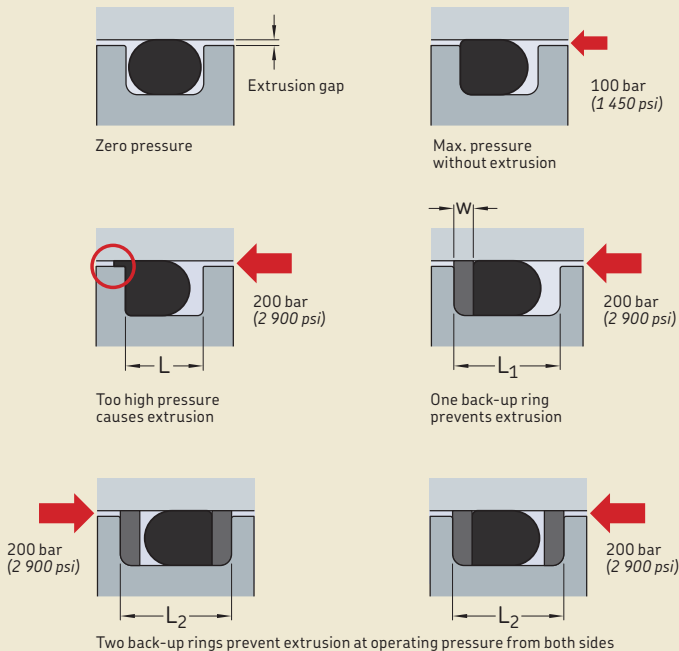

For additional information about O-ring and back-up ring materials, refer to *Materials* (→ **page 292**) and about extrusion, refer to *Gap extrusion* (→ **page 34**).

### Groove width

To accommodate the additional back-up rings, the O-ring groove width  $L$  needs to be increased to  $L_1$  for one back-up ring or  $L_2$  for two back-up rings (→ **fig. 2**). The groove width dimensions are listed in the product tables.

Diagram 2

Guideline limit values for NBR O-rings, 70 shA

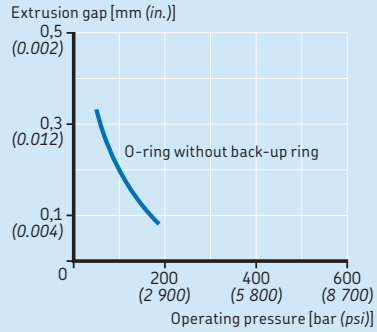

Diagram 3

Guideline limit values from test with OR 89.5×3-N70 and STR 90×95×1.3

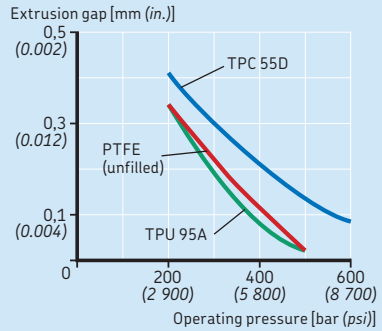
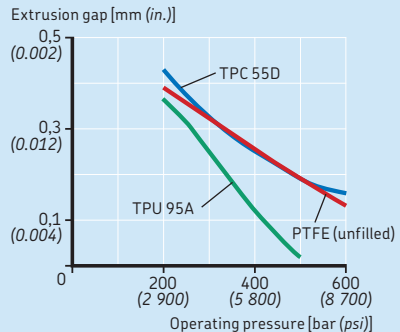

Diagram 4

Guideline limit values from test with OR 89.1×5.7-N70 and STR 90×100×1.7



## 6.1 OR O-rings in static radial sealing, metric sizes

ID 2,9 – 17,3 mm

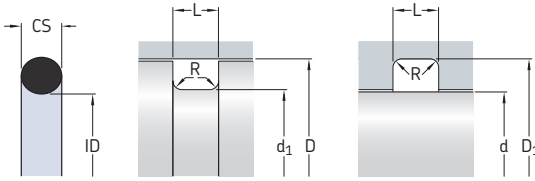

SKF recommends designing O-ring housings according to ISO 3601.  
This table is a reference to O-ring sizes for common housing dimensions.

O-ring dimensions		Housing dimensions						Dash-number	Designation
ID	CS	Outside groove		Inside groove					
mm	mm	L +0,2	R max.	D H9	d <sub>1</sub> h11	d h8	D <sub>1</sub> H11	-	-
2,9	1,78	2,4	0,5	6,35	3,73	3,12	5,74	006	OR 2.9x1.78-N70
3,1	1,6	2,3	0,5	6	3,8	-	-	-	OR 3.1x1.6-N70
3,3	2,4	3,2	0,5	8	4,4	4,00	8	-	OR 3.3x2.4-N70
3,69	1,78	2,4	0,5	7,14	4,52	3,91	6,53	007	OR 3.69x1.78-N70
4,1	1,6	2,3	0,5	7	4,8	-	-	-	OR 4.1x1.6-N70
4,3	2,4	3,2	0,5	9	5,4	5,00	9	-	OR 4.3x2.4-N70
4,48	1,78	2,4	0,5	7,93	5,31	4,70	7,32	008	OR 4.48x1.78-N70
5,1	1,6	2,3	0,5	8	5,8	-	-	-	OR 5.1x1.6-N70
5,28	1,78	2,4	0,5	8,74	6,12	5,51	8,13	009	OR 5.28x1.78-N70
5,3	2,4	3,2	0,5	10	6,4	6,00	10	-	OR 5.3x2.4-N70
6,07	1,78	2,4	0,5	9,53	6,91	6,30	8,92	010	OR 6.07x1.78-N70
6,1	1,6	2,3	0,5	9	6,8	-	-	-	OR 6.1x1.6-N70
6,3	2,4	3,2	0,5	11	7,4	7,00	11	-	OR 6.3x2.4-N70
6,75	1,78	2,4	0,5	10,32	7,7	7,08	9,7	-	OR 6.75x1.78-N70
7,1	1,6	2,3	0,5	10	7,8	-	-	-	OR 7.1x1.6-N70
7,3	2,4	3,2	0,5	12	8,4	8,00	12	-	OR 7.3x2.4-N70
7,65	1,78	2,4	0,5	11,11	8,49	7,78	10,49	-	OR 7.65x1.78-N70
8,1	1,6	2,3	0,5	11	8,8	-	-	-	OR 8.1x1.6-N70
8,3	2,4	3,2	0,5	13	9,4	9,00	13	-	OR 8.3x2.4-N70
8,73	1,78	2,4	0,5	12,3	9,68	9,07	11,69	-	OR 8.73x1.78-N70
9,1	1,6	2,3	0,5	12	9,8	-	-	-	OR 9.1x1.6-N70

O-ring dimensions		Housing dimensions						Dash-number	Designation
ID	CS	Outside groove			Inside groove				
		L +0,2	R max.	D H9	d <sub>1</sub> h11	d h8	D <sub>1</sub> H11		
mm		mm						-	-
9,19	2,62	3,6	0,8	14,29	10,1	9,47	13,66	110	OR 9.19x2.62-N70
9,25	1,78	2,4	0,5	12,7	10,08	9,47	12,09	012	OR 9.25x1.78-N70
9,3	2,4	3,2	0,5	14	10,4	10,00	14	-	OR 9.3x2.4-N70
9,92	2,62	3,6	0,8	15,08	10,89	10,26	14,45	-	OR 9.92x2.62-N70
10,1	1,6	2,3	0,5	13	10,8	-	-	-	OR 10.1x1.6-N70
10,3	2,4	3,2	0,5	15	11,4	11,00	15	-	OR 10.3x2.4-N70
10,78	2,62	3,6	0,8	15,88	11,69	11,05	15,24	111	OR 10.78x2.62-N70
10,82	1,78	2,4	0,5	14,3	11,68	11,10	13,72	013	OR 10.82x1.78-N70
11,1	1,6	2,3	0,5	14	11,8	-	-	-	OR 11.1x1.6-N70
11,11	1,78	2,4	0,5	14,68	12,06	11,51	14,13	-	OR 11.11x1.78-N70
11,3	2,4	3,2	0,5	16	12,4	12,00	16	-	OR 11.3x2.4-N70
11,91	2,62	3,6	0,8	17,07	12,88	12,24	16,43	-	OR 11.91x2.62-N70
12,1	1,6	2,3	0,5	15	12,8	-	-	-	OR 12.1x1.6-N70
12,3	2,4	3,2	0,5	17	13,4	13,00	17	-	OR 12.3x2.4-N70
12,37	2,62	3,6	0,8	17,46	13,27	12,65	16,84	112	OR 12.37x2.62-N70
12,42	1,78	2,4	0,5	15,88	13,26	12,70	15,32	014	OR 12.42x1.78-N70
13,1	1,6	2,3	0,5	16	13,8	-	-	-	OR 13.1x1.6-N70
	2,62	3,6	0,8	18,26	14,07	13,43	17,62	-	OR 13.1x2.62-N70
13,3	2,4	3,2	0,5	18	14,4	14,00	18	-	OR 13.3x2.4-N70
13,94	2,62	3,6	0,8	19,05	14,86	14,22	18,41	-	OR 13.94x2.62-N70
14	1,78	2,4	0,5	17,48	14,86	14,28	16,9	015	OR 14.0x1.78-N70
14,1	1,6	2,3	0,5	17	14,8	-	-	-	OR 14.1x1.6-N70
14,3	2,4	3,2	0,5	19	15,4	15,00	19	-	OR 14.3x2.4-N70
15,08	2,62	3,6	0,8	20,24	16,05	15,42	19,61	-	OR 15.8x2.62-N70
15,1	1,6	2,3	0,5	18	15,8	-	-	-	OR 15.1x1.6-N70
15,3	2,4	3,2	0,5	20	16,4	16,00	20	-	OR 15.3x2.4-N70
15,54	2,62	3,6	0,8	20,64	16,45	15,82	20,01	114	OR 15.54x2.62-N70
15,6	1,78	2,4	0,5	19,05	16,43	15,88	18,5	016	OR 15.6x1.78-N70
15,88	2,62	3,6	0,8	21,03	16,84	16,20	20,39	-	OR 15.88x2.62-N70
16,1	1,6	2,3	0,5	19	16,8	-	-	-	OR 16.1x1.6-N70
16,3	2,4	3,2	0,5	21	17,4	17,00	21	-	OR 16.3x2.4-N70
17,1	1,6	2,3	0,5	20	17,8	-	-	-	OR 17.1x1.6-N70
17,12	2,62	3,6	0,8	22,23	18,04	17,40	21,59	-	OR 17.12x2.62-N70
17,17	1,78	2,4	0,5	20,63	18,01	17,48	20,1	017	OR 17.17x1.78-N70
17,3	2,4	3,2	0,5	22	18,4	18,00	22	-	OR 17.3x2.4-N70

## 6.1 OR O-rings in static radial sealing, metric sizes

ID 17,86 – 37,1 mm

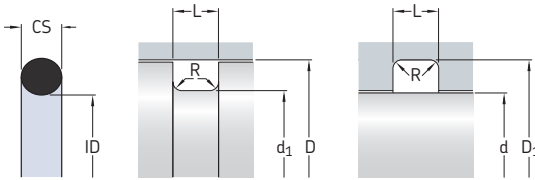

SKF recommends designing O-ring housings according to ISO 3601.  
This table is a reference to O-ring sizes for common housing dimensions.

O-ring dimensions		Housing dimensions						Dash-number	Designation
ID	CS	Outside groove				Inside groove			
mm	mm	L +0,2	R max.	D H9	d <sub>1</sub> h11	d h8	D <sub>1</sub> H11	-	-
17,86	2,62	3,6	0,8	23,02	18,83	18,20	22,39	-	OR 17.86x2.62-N70
18,1	1,6	2,3	0,5	21	18,8	-	-	-	OR 18.1x1.6-N70
18,64	3,53	4,8	1	25,43	19,71	19,00	24,72	210	OR 18.64x3.53-N70
18,72	2,62	3,6	0,8	23,81	19,62	19,00	23,19	116	OR 18.72x2.62-N70
18,77	1,78	2,4	0,5	22,23	19,61	19,05	21,67	018	OR 18.77x1.78-N70
19,1	1,6	2,3	0,5	22	19,8	-	-	-	OR 19.1x1.6-N70
19,2	3	4	1	25	20,2	20,00	25	-	OR 19.2x3.0-N70
20,22	3,53	4,8	1	27	21,28	20,55	26,27	211	OR 20.22x3.53-N70
20,35	1,78	2,4	0,5	23,8	21,18	20,63	23,25	019	OR 20.35x1.78-N70
20,63	2,62	3,6	0,8	25,8	21,61	21,03	25,22	-	OR 20.63x2.62-N70
21,82	3,53	4,8	1	28,6	22,88	22,15	27,87	212	OR 21.82x3.53-N70
21,95	1,78	2,4	0,5	25,4	22,78	22,23	24,85	020	OR 21.95x1.78-N70
22,1	1,6	2,3	0,5	25	22,8	-	-	-	OR 22.1x1.6-N70
22,2	3	4	1	28	23,2	23,00	28	-	OR 22.2x3.0-N70
22,22	2,62	3,6	0,8	27,38	23,19	22,62	26,81	-	OR 22.22x2.62-N70
23,4	3,53	4,8	1	30,18	24,46	23,72	29,44	213	OR 23.4x3.53-N70
23,47	2,62	3,6	0,8	28,58	24,39	23,80	27,99	119	OR 23.47x2.62-N70
23,52	1,78	2,4	0,5	26,98	24,36	23,81	26,42	021	OR 23.52x1.78-N70
23,81	2,62	3,6	0,8	28,97	24,78	24,21	28,4	-	OR 23.81x2.62-N70
24,2	3	4	1	30	25,2	25,00	30	-	OR 24.2x3.0-N70
24,99	3,53	4,8	1	31,78	26,06	25,32	31,04	214	OR 24.99x3.53-N70



O-ring dimensions		Housing dimensions						Dash-number	Designation
ID	CS	L +0,2	R max.	Outside groove		Inside groove			
mm	mm			D H9	d <sub>1</sub> h11	d h8	D <sub>1</sub> H11	-	-
25,07	2,62	3,6	0,8	30,18	25,99	25,40	29,59	120	OR 25.07x2.62-N70
25,1	1,6	2,3	0,5	28	25,8	-	-	-	OR 25.1x1.6-N70
25,12	1,78	2,4	0,5	28,58	25,96	25,40	28,02	022	OR 25.12x1.78-N70
25,8	3,53	4,8	1	32,58	26,86	26,13	31,85	-	OR 25.8x3.53-N70
26,2	3	4	1	32	27,2	27,00	32	-	OR 26.2x3.0-N70
26,58	3,53	4,8	1	33,35	27,63	26,90	32,62	215	OR 26.58x3.53-N70
26,64	2,62	3,6	0,8	31,75	27,56	26,98	31,17	121	OR 26.64x2.62-N70
26,7	1,78	2,4	0,5	30,18	27,56	26,98	29,6	023	OR 26.7x1.78-N70
27,1	1,6	2,3	0,5	30	27,8	-	-	-	OR 27.1x1.6-N70
28,17	3,53	4,8	1	34,95	29,23	28,50	34,22	216	OR 28.17x3.53-N70
28,25	2,62	3,6	0,8	33,33	29,14	28,58	32,77	-	OR 28.25x2.62-N70
28,3	1,78	2,4	0,5	31,75	29,13	28,58	31,2	024	OR 28.3x1.78-N70
29,1	1,6	2,3	0,5	32	29,8	-	-	-	OR 29.1x1.6-N70
29,2	3	4	1	35	30,2	30,00	35	-	OR 29.2x3.0-N70
29,74	3,53	4,8	1	36,53	30,81	30,07	35,79	-	OR 29.74x3.53-N70
29,82	2,62	3,6	0,8	34,93	30,74	30,18	34,37	123	OR 29.82x2.62-N70
29,87	1,78	2,4	0,5	33,33	30,71	30,18	32,8	025	OR 29.87x1.78-N70
31,34	3,53	4,8	1	38,13	32,41	31,67	37,39	218	OR 31.34x3.53-N70
31,42	2,62	3,6	0,8	36,5	32,31	31,75	35,94	124	OR 31.42x2.62-N70
31,47	1,78	2,4	0,5	34,93	32,31	31,75	34,37	026	OR 31.47x1.78-N70
32,1	1,6	2,3	0,5	35	32,8	-	-	-	OR 32.1x1.6-N70
32,2	3	4	1	38	33,2	33,00	38	-	OR 32.2x3.0-N70
32,92	3,53	4,8	1	39,7	33,98	33,25	38,97	-	OR 32.92x3.53-N70
32,99	2,62	3,6	0,8	38,1	33,91	33,33	37,52	-	OR 32.99x2.62-N70
33,05	1,78	2,4	0,5	36,5	33,88	33,33	35,95	027	OR 33.05x1.78-N70
34,2	3	4	1	40	35,2	35,00	40	-	OR 34.2x3.0-N70
34,52	3,53	4,8	1	41,3	35,58	34,85	40,57	220	OR 34.52x3.53-N70
34,59	2,62	3,6	0,8	39,7	35,51	34,93	39,12	126	OR 34.59x2.62-N70
34,65	1,78	2,4	0,5	38,1	35,48	34,93	37,55	028	OR 34.65x1.78-N70
35,1	1,6	2,3	0,5	38	35,8	-	-	-	OR 35.1x1.6-N70
36,1	3,53	4,8	1	42,88	37,16	36,42	42,14	221	OR 36.1x3.53-N70
36,17	2,62	3,6	0,8	41,28	37,09	36,50	40,69	127	OR 36.17x2.62-N70
36,2	3	4	1	42	37,2	37,00	42	-	OR 36.2x3.0-N70
37,1	1,6	2,3	0,5	40	37,8	-	-	-	OR 37.1x1.6-N70

## 6.1 OR O-rings in static radial sealing, metric sizes

ID 37,47 – 61,91 mm

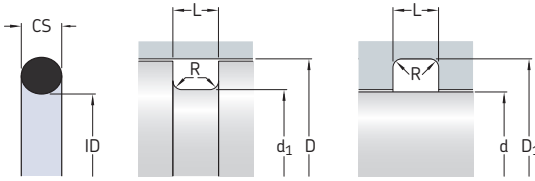

SKF recommends designing O-ring housings according to ISO 3601.  
This table is a reference to O-ring sizes for common housing dimensions.

O-ring dimensions		Housing dimensions				Inside groove		Dash-number	Designation
ID	CS	Outside groove		Inside groove		d	D <sub>1</sub>		
mm	mm	L +0,2	R max.	D H9	d <sub>1</sub> h11	h8	H11	-	-
37,47	5,33	7,1	1	47,65	38,89	38,02	46,78	325	OR 37.47x5.33-N70
37,69	3,53	4,8	1	44,48	38,76	38,02	43,74	222	OR 37.69x3.53-N70
37,77	2,62	3,6	0,8	42,88	38,69	38,10	42,29	128	OR 37.77x2.62-N70
39,2	3	4	1	45	40,2	40,00	45	-	OR 39.2x3.0-N70
39,34	2,62	3,6	0,8	44,45	40,26	39,68	43,87	129	OR 39.34x2.62-N70
39,69	3,53	4,8	1	46,49	40,77	40,02	45,74	-	OR 39.69x3.53-N70
40,65	5,33	7,1	1	50,83	42,07	41,20	49,96	326	OR 40.65x5.33-N70
40,87	3,53	4,8	1	47,65	41,94	41,20	46,91	223	OR 40.87x3.53-N70
40,95	2,62	3,6	0,8	46,03	41,84	41,28	45,47	130	OR 40.95x2.62-N70
41,28	3,53	4,8	1	48,05	42,33	41,61	47,33	-	OR 41.28x3.53-N70
42,2	3	4	1	48	43,2	43,00	48	-	OR 42.2x3.0-N70
42,52	2,62	3,6	0,8	47,63	43,44	42,88	47,07	131	OR 42.52x2.62-N70
42,86	3,53	4,8	1	49,64	43,92	43,19	48,91	-	OR 42.86x3.53-N70
43,82	5,33	7,1	1	54	45,24	44,37	53,13	327	OR 43.82x5.33-N70
44,04	3,53	4,8	1	50,83	45,11	44,37	50,09	224	OR 44.04x3.53-N70
44,12	2,62	3,6	0,8	49,2	45,01	44,45	48,64	132	OR 44.12x2.62-N70
44,2	3	4	1	50	45,2	45,00	50	-	OR 44.2x3.0-N70
	5,7	7,5	1	55	45,3	45,00	55	-	OR 44.2x5.7-N70
44,45	3,53	4,8	1	51,22	45,5	44,77	50,49	-	OR 44.45x3.53-N70
45,69	2,62	3,6	0,8	50,8	46,61	46,03	50,22	133	OR 45.69x2.62-N70
46,04	3,53	4,8	1	52,8	47,08	46,35	52,07	-	OR 46.04x3.53-N70
46,99	5,33	7,1	1	57,18	48,42	47,55	56,31	328	OR 46.99x5.33-N70

O-ring dimensions		Housing dimensions						Dash-number	Designation
ID	CS	Outside groove			Inside groove				
		L +0,2	R max.	D H9	d <sub>1</sub> h11	d h8	D <sub>1</sub> H11		
mm		mm						-	-
47,22	3,53	4,8	1	54	48,29	47,55	53,26	225	OR 47.22x3.53-N70
47,29	2,62	3,6	0,8	52,38	48,19	47,63	51,82	134	OR 47.29x2.62-N70
47,63	3,53	4,8	1	54,39	48,67	47,94	53,66	-	OR 47.63x3.53-N70
48,9	2,62	3,6	0,8	53,98	49,79	49,20	53,39	135	OR 48.9x2.62-N70
49,2	5,7	7,5	1	60	50,3	50,00	60	-	OR 49.2x5.7-N70
49,21	3,53	4,8	1	55,98	50,26	49,53	55,25	-	OR 49.21x3.53-N70
49,5	3	3,7	1	55	50,2	-	-	-	OR 49.5x3.0-N70
50,16	5,33	7,1	1	60,35	51,59	50,72	59,48	329	OR 50.16x5.33-N70
50,4	3,53	4,8	1	57,18	51,46	50,72	56,44	226	OR 50.4x3.53-N70
50,47	2,62	3,6	0,8	55,58	51,39	50,80	54,99	136	OR 50.47x2.62-N70
50,8	3,53	4,8	1	57,57	51,85	51,12	56,84	-	OR 50.8x3.53-N70
52,07	2,62	3,6	0,8	57,15	52,96	52,38	56,57	137	OR 52.07x2.62-N70
52,39	3,53	4,8	1	59,17	53,45	52,70	58,42	-	OR 52.39x3.53-N70
53,34	5,33	7,1	1	63,53	54,77	53,90	62,66	330	OR 53.34x5.33-N70
53,56	3,53	4,8	1	60,35	54,64	53,90	59,61	227	OR 53.56x3.53-N70
53,64	2,62	3,6	0,8	58,73	54,54	53,98	58,17	138	OR 53.64x2.62-N70
53,97	3,53	4,8	1	60,74	55,02	54,29	60,01	-	OR 53.97x3.53-N70
54,2	5,7	7,5	1	65	55,3	55,00	65	-	OR 54.2x5.7-N70
54,5	3	3,7	1	60	55,2	-	-	-	OR 54.5x3.0-N70
55,25	2,62	3,6	0,8	60,33	56,14	55,58	59,77	139	OR 55.25x2.62-N70
55,56	3,53	4,8	1	62,34	56,62	55,88	61,6	-	OR 55.56x3.53-N70
56,52	5,33	7,1	1	66,7	57,94	57,07	65,83	331	OR 56.52x5.33-N70
56,74	3,53	4,8	1	63,92	57,81	57,07	62,79	228	OR 56.74x3.53-N70
56,82	2,62	3,6	0,8	61,9	57,71	57,15	61,34	140	OR 56.82x2.62-N70
57,15	3,53	4,8	1	63,92	58,22	57,47	63,19	-	OR 57.15x3.53-N70
58,42	2,62	3,6	0,8	63,5	59,31	58,73	62,92	141	OR 58.42x2.62-N70
58,74	3,53	4,8	1	65,5	59,78	59,05	64,77	-	OR 58.74x3.53-N70
59,2	5,7	7,5	1	70	60,3	60,00	70	-	OR 59.2x5.7-N70
59,5	3	3,7	1	65	60,2	-	-	-	OR 59.5x3.0-N70
59,69	5,33	7,1	1	69,88	61,12	60,25	69,01	332	OR 59.69x5.33-N70
59,92	3,53	4,8	1	66,7	60,99	60,25	65,96	229	OR 59.92x3.53-N70
60	2,62	3,6	0,8	65,1	60,91	60,33	64,52	142	OR 60.0x2.62-N70
60,33	3,53	4,8	1	67,09	61,37	60,66	66,38	-	OR 60.33x3.53-N70
61,6	2,62	3,6	0,8	66,68	62,49	61,90	66,09	143	OR 61.6x2.62-N70
61,91	3,53	4,8	1	68,68	62,96	62,23	67,95	-	OR 61.91x3.53-N70

## 6.1 OR O-rings in static radial sealing, metric sizes

ID 62,87 – 97,79 mm

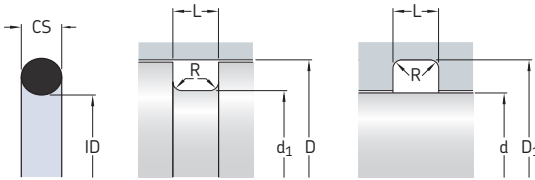

SKF recommends designing O-ring housings according to ISO 3601.  
This table is a reference to O-ring sizes for common housing dimensions.

O-ring dimensions		Housing dimensions						Dash-number	Designation
ID	CS	Outside groove		Inside groove					
mm	mm	L +0,2	R max.	D H9	d <sub>1</sub> h11	d h8	D <sub>1</sub> H11	-	-
62,87	5,33	7,1	1	73,05	64,29	63,42	72,18	333	OR 62.87x5.33-N70
63,09	3,53	4,8	1	69,88	64,16	63,42	69,14	230	OR 63.09x3.53-N70
63,17	2,62	3,6	0,8	68,28	64,09	63,50	67,69	144	OR 63.17x2.62-N70
63,5	3,53	4,8	1	70,27	64,55	63,82	69,54	-	OR 63.5x3.53-N70
64,2	5,7	7,5	1	75	65,3	65,00	75	-	OR 64.2x5.7-N70
64,5	3	3,7	1	70	65,2	-	-	-	OR 64.5x3.0-N70
64,77	2,62	3,6	0,8	69,85	65,66	65,08	69,27	145	OR 64.77x2.62-N70
65,09	3,53	4,8	1	71,85	66,13	65,40	71,12	-	OR 65.09x3.53-N70
66,04	5,33	7,1	1	76,23	67,47	66,60	75,36	334	OR 66.04x5.33-N70
66,27	3,53	4,8	1	73,05	67,34	66,60	72,31	231	OR 66.27x3.53-N70
66,34	2,62	3,6	0,8	71,43	67,24	66,68	70,87	146	OR 66.34x2.62-N70
66,68	3,53	4,8	1	73,45	67,75	67,00	72,72	-	OR 66.68x3.53-N70
67,94	2,62	3,6	0,8	73,03	68,84	68,28	72,47	-	OR 67.94x2.62-N70
68,26	3,53	4,8	1	75,02	69,3	68,58	74,3	-	OR 68.26x3.53-N70
69,2	5,7	7,5	1	80	70,3	70,00	80	-	OR 69.2x5.7-N70
69,22	5,33	7,1	1	79,4	70,64	69,77	78,53	335	OR 69.22x5.33-N70
69,44	3,53	4,8	1	76,23	70,51	69,77	75,49	232	OR 69.44x3.53-N70
69,5	3	3,7	1	75	70,2	70,00	74,8	-	OR 69.5x3.0-N70
69,52	2,62	3,6	0,8	74,6	70,41	69,85	74,04	148	OR 69.52x2.62-N70
69,85	3,53	4,8	1	76,62	70,9	70,17	75,89	-	OR 69.85x3.53-N70

O-ring dimensions		Housing dimensions						Dash-number	Designation
ID	CS	Outside groove			Inside groove				
		L +0,2	R max.	D H9	d <sub>1</sub> h11	d h8	D <sub>1</sub> H11		
mm		mm						-	-
71,12	2,62	3,6	0,8	76,6	72,01	71,43	75,62	149	OR 71.12x2.62-N70
71,44	3,53	4,8	1	78,2	72,48	71,75	77,47	-	OR 71.44x3.53-N70
72,39	5,33	7,1	1	82,58	73,82	72,95	81,71	336	OR 72.39x5.33-N70
72,62	3,53	4,8	1	79,4	73,69	72,95	78,66	233	OR 72.62x3.53-N70
73,02	3,53	4,8	1	79,79	74,04	73,34	79,06	-	OR 73.02x3.53-N70
74,2	5,7	7,5	1	85	75,3	75,00	85	-	OR 74.2x5.7-N70
74,5	3	3,7	1	80	75,2	75,00	79,8	-	OR 74.5x3.0-N70
74,60	3,53	4,8	1	81,38	75,66	74,93	80,65	-	OR 74.60x3.53-N70
74,63	5,33	7,1	1	85	76,24	75,35	84,11	-	OR 74.63x5.33-N70
75,57	5,33	7,1	1	85,78	77,02	76,10	84,86	337	OR 75.57x5.33-N70
75,79	3,53	4,8	1	82,58	76,86	76,10	81,81	234	OR 75.79x3.53-N70
78,74	5,33	7,1	1	88,95	80,19	79,27	88,03	338	OR 78.74x5.33-N70
78,97	3,53	4,8	1	85,78	80,06	79,27	84,99	235	OR 78.97x3.53-N70
79,2	5,7	7,5	1	90	80,3	80,00	90	-	OR 79.2x5.7-N70
79,5	3	3,7	1	85	80,2	80,00	84,8	-	OR 79.5x3.0-N70
79,73	5,33	7,1	1	90,93	82,17	81,29	90,05	-	OR 79.73x5.33-N70
81,92	5,33	7,1	1	92,13	83,37	82,45	91,21	339	OR 81.92x5.33-N70
82,14	3,53	4,8	1	88,95	83,23	82,45	88,16	236	OR 82.14x3.53-N70
84,1	5,7	7,5	1	95	85,3	85,00	95	-	OR 84.1x5.7-N70
84,5	3	3,7	1	90	85,2	85,00	89,8	-	OR 84.5x3.0-N70
85,09	5,33	7,1	1	95,3	86,54	85,62	94,38	340	OR 85.09x5.33-N70
85,32	3,53	4,8	1	92,13	86,41	85,62	91,34	237	OR 85.32x3.53-N70
88,27	5,33	7,1	1	98,48	89,72	88,80	97,56	341	OR 88.27x5.33-N70
88,49	3,53	4,8	1	95,09	89,37	88,80	94,51	238	OR 88.49x3.53-N70
89,1	5,7	7,5	1	100	90,3	90,00	100	-	OR 89.1x5.7-N70
89,5	3	3,7	1	95	90,2	90,00	94,8	-	OR 89.5x3.0-N70
89,69	5,33	7,1	1	100,06	91,3	90,40	99,16	-	OR 89.69x5.33-N70
91,44	5,33	7,1	1	101,65	92,89	91,97	100,73	342	OR 91.44x5.33-N70
91,67	3,53	4,8	1	98,48	92,76	91,97	97,69	239	OR 91.67x3.53-N70
94,1	5,7	7,5	1	105	95,3	95,00	105	-	OR 94.1x5.7-N70
94,5	3	3,7	1	100	95,2	95,00	99,8	-	OR 94.5x3.0-N70
94,62	5,33	7,1	1	104,83	96,07	95,15	103,91	343	OR 94.62x5.33-N70
94,84	3,53	4,8	1	-	-	95,15	100,86	240	OR 94.84x3.53-N70
97,79	5,33	7,1	1	108	99,24	98,32	107,08	344	OR 97.79x5.33-N70

## 6.1 OR O-rings in static radial sealing, metric sizes

ID 98,02 – 120 mm

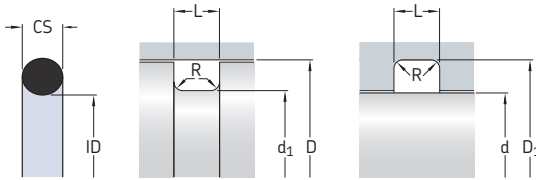

SKF recommends designing O-ring housings according to ISO 3601.  
This table is a reference to O-ring sizes for common housing dimensions.

O-ring dimensions		Housing dimensions						Dash-number	Designation
ID	CS	Outside groove		Inside groove					
mm	mm	L +0,2	R max.	D H9	d <sub>1</sub> h11	d h8	D <sub>1</sub> H11	-	-
98,02	3,53	4,8	1	-	-	98,32	104,04	241	OR 98.02x3.53-N70
99,1	5,7	7,5	1	110	100,3	100,00	110	-	OR 99.1x5.7-N70
99,5	3	3,7	1	105	100,2	100,00	104,8	-	OR 99.5x3.0-N70
100	5,33	7,1	1	110,38	101,62	100,74	109,5	-	OR 100.0x5.33-N70
100,97	5,33	7,1	1	111,18	102,48	101,50	110,26	345	OR 100.97x5.33-N70
101,19	3,53	4,8	1	-	-	101,50	107,21	242	OR 101.19x3.53-N70
104,1	5,7	7,5	1	115	105,3	105,00	115	-	OR 104.1x5.7-N70
104,14	5,33	7,1	1	114,35	105,54	104,67	113,43	346	OR 104.14x5.33-N70
104,37	3,53	4,8	1	-	-	104,67	110,39	243	OR 104.37x3.53-N70
104,5	3	3,7	1	110	105,2	105,00	109,8	-	OR 104.5x3.0-N70
107,32	5,33	7,1	1	117,53	108,77	107,85	116,61	347	OR 107.32x5.33-N70
107,54	3,53	4,8	1	-	-	107,85	113,56	244	OR 107.54x3.53-N70
109,1	5,7	7,5	1	120	110,3	110,00	120	-	OR 109.1x5.7-N70
	3	3,7	1	115	110,2	110,00	114,8	-	OR 109.5x3.0-N70
109,5	5,33	7,1	1	119,91	111,15	110,23	118,99	-	OR 109.5x5.33-N70
110,49	5,33	7,1	1	120,7	111,94	111,05	119,81	348	OR 110.49x5.33-N70
110,72	3,53	4,8	1	-	-	111,02	116,74	245	OR 110.72x3.53-N70
113,67	5,33	7,1	1	123,88	115,12	114,20	122,96	349	OR 113.67x5.33-N70
113,7	6,99	9,5	1,5	127,1	115,95	114,20	125,35	425	OR 113.7x6.99-N70
113,89	3,53	4,8	1	-	-	114,20	119,91	246	OR 113.89x3.53-N70
114,3	5,7	7,5	1	125	115,3	115,00	125	-	OR 114.3x5.7-N70

O-ring dimensions		Housing dimensions						Dash-number	Designation
ID	CS	L +0,2	R max.	Outside groove		Inside groove			
mm		mm		D H9	d <sub>1</sub> h11	d h8	D <sub>1</sub> H11		
								-	-
<b>114,5</b>	3	3,7	1	120	115,2	115,00	119,8	-	<b>OR 114.5x3.0-N70</b>
<b>114,7</b>	6,99	9,5	1,5	128,3	117,15	115,20	126,35	-	<b>OR 114.7x6.99-N70</b>
<b>116,8</b>	6,99	9,5	1,5	130,2	119,05	117,30	128,45	426	<b>OR 116.8x6.99-N70</b>
<b>117,07</b>	3,53	4,8	1	-	-	117,37	123,09	247	<b>OR 117.07x3.53-N70</b>
<b>117,5</b>	5,33	7,1	1	127,84	119,08	118,17	126,93	-	<b>OR 117.5x5.33-N70</b>
<b>119,3</b>	5,7	7,5	1	130	120,3	120,00	130	-	<b>OR 119.3x5.7-N70</b>
<b>119,5</b>	3	3,7	1	125	120,2	120,00	124,8	-	<b>OR 119.5x3.0-N70</b>
<b>120</b>	6,99	9,5	1,5	133,4	122,25	120,50	131,65	427	<b>OR 120.0x6.99-N70</b>

## 6.1 OR O-rings in static radial sealing, metric sizes

ID 120,24 – 164,3 mm

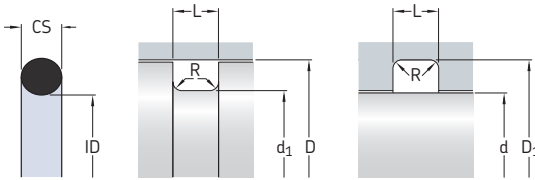

SKF recommends designing O-ring housings according to ISO 3601.  
This table is a reference to O-ring sizes for common housing dimensions.

O-ring dimensions		Housing dimensions						Dash-number	Designation
ID	CS	Outside groove		Inside groove					
mm	mm	L +0,2	R max.	D H8	d <sub>1</sub> h11	d h7	D <sub>1</sub> H11	-	-
120,24	3,53	4,8	1	-	-	120,55	126,26	248	OR 120.24x3.53-N70
120,7	5,33	7,1	1	131,02	122,26	121,34	130,1	-	OR 120.7x5.33-N70
123,19	6,99	9,5	1,5	136,6	125,45	123,70	134,85	428	OR 123.2x6.99-N70
123,42	3,53	4,8	1	-	-	123,72	129,44	249	OR 123.42x3.53-N70
123,8	5,33	7,1	1	134,19	125,43	124,12	132,88	-	OR 123.8x5.33-N70
124,3	5,7	6,4	1	135	125,3	125,00	134,7	-	OR 124.3x5.7-N70
124,5	3	3,7	1	130	125,2	125,00	129,8	-	OR 124.5x3.0-N70
124,6	6,99	9,5	1,5	138,2	127,05	125,10	136,25	-	OR 124.6x6.99-N70
126,37	6,99	9,5	1,5	139,8	128,65	126,90	138,05	429	OR 126.37x6.99-N70
126,59	3,53	4,8	1	-	-	126,90	132,61	250	OR 126.59x3.53-N70
127	5,33	7,1	1	137,37	128,61	127,69	136,45	-	OR 127.0x5.33-N70
129,3	5,7	7,5	1	140	130,3	130,00	140	-	OR 129.3x5.7-N70
129,5	3	3,7	1	135	130,2	130,00	134,8	-	OR 129.5x3.0-N70
	6,99	9,5	1,5	142,9	131,75	130,00	141,15	-	OR 129.5x6.99-N70
129,77	3,53	4,8	1	-	-	130,07	135,79	251	OR 129.77x3.53-N70
130,2	5,33	7,1	1	140,54	131,78	130,87	139,63	-	OR 130.2x5.33-N70
132,7	6,99	9,5	1,5	146,1	134,95	133,20	144,35	431	OR 132.7x6.99-N70
132,94	3,53	4,8	1	-	-	133,25	138,96	252	OR 132.94x3.53-N70
133,4	5,33	7,1	1	143,72	134,96	134,04	142,8	-	OR 133.4x5.33-N70
134,3	5,7	7,5	1	145	135,3	135,00	145	-	OR 134.3x5.7-N70
134,5	3	3,7	1	140	135,2	135,00	139,8	-	OR 134.5x3.0-N70
	6,99	9,5	1,5	148,2	137,05	135,00	146,15	-	OR 134.5x6.99-N70



O-ring dimensions		Housing dimensions						Dash-number	Designation
ID	CS	L +0,2	R max.	Outside groove		Inside groove			
mm	mm			D H8	d <sub>1</sub> h11	d h7	D <sub>1</sub> H11	-	-
135,9	6,99	9,5	1,5	149,3	138,15	138,15	149,3	432	OR 135.9x6.99-N70
136,12	3,53	4,8	1	-	-	136,42	142,14	253	OR 136.12x3.53-N70
136,5	5,33	7,1	1	146,89	138,13	137,22	145,98	-	OR 136.5x5.33-N70
139,07	6,99	9,5	1,5	152,5	141,35	141,35	152,5	433	OR 139.07x6.99-N70
139,29	3,53	4,8	1	-	-	139,60	145,31	254	OR 139.29x3.53-N70
139,3	5,7	7,5	1	150	140,3	140,00	150	-	OR 139.3x5.7-N70
139,5	3	3,7	1	145	140,2	140,00	144,8	-	OR 139.5x3.0-N70
139,7	5,33	7,1	1	150,07	141,31	140,39	149,15	-	OR 139.7x5.33-N70
142,24	6,99	9,5	1,5	155,6	144,45	144,45	155,6	434	OR 142.24x6.99-N70
142,47	3,53	4,8	1	-	-	142,77	148,49	255	OR 142.47x3.53-N70
142,88	5,33	7,1	1	153,24	144,48	143,57	152,33	-	OR 142.88x5.33-N70
144,1	8,4	11	1	160	145	145,00	160	-	OR 144.1x8.4-N70
144,3	5,7	7,5	1	155	145,3	145,00	155	-	OR 144.3x5.7-N70
144,5	3	3,7	1	150	145,2	145,00	149,8	-	OR 144.5x3.0-N70
145,4	6,99	9,5	1,5	158,8	147,65	147,65	158,8	435	OR 145.4x6.99-N70
145,64	3,53	4,8	1	-	-	145,95	151,66	256	OR 145.64x3.53-N70
146,1	5,33	7,1	1	156,42	147,66	146,74	155,5	-	OR 146.1x5.33-N70
148,6	6,99	9,5	1,5	162	150,85	150,85	162	436	OR 148.6x6.99-N70
148,82	3,53	4,8	1	-	-	149,12	154,84	257	OR 148.82x3.53-N70
149,1	8,4	11	1	165	150	150,00	165	-	OR 149.1x8.4-N70
149,2	5,33	7,1	1	159,59	150,83	149,92	158,68	-	OR 149.2x5.33-N70
149,3	5,7	6,4	1	160	150,4	150,00	159,6	-	OR 149.3x5.7-N70
151,8	6,99	9,5	1,5	165,2	154,05	154,05	165,2	437	OR 151.8x6.99-N70
151,99	3,53	4,8	1	-	-	152,30	158,01	258	OR 151.99x3.53-N70
154,1	8,4	11	1	170	155	155,00	170	-	OR 154.1x8.4-N70
154,3	5,7	6,4	1	165	155,4	155,00	164,6	-	OR 154.3x5.7-N70
155,6	6,99	9,5	1,5	169	157,85	157,85	169	-	OR 155.6x6.99-N70
158,12	6,99	9,5	1,5	171,5	160,35	160,35	171,5	438	OR 158.12x6.99-N70
158,34	3,53	4,8	1	-	-	158,65	164,36	259	OR 158.34x3.53-N70
159,1	8,4	11	1	175	160	160,00	175	-	OR 159.1x8.4-N70
159,3	5,7	6,4	1	170	160,4	160,00	169,6	-	OR 159.3x5.7-N70
159,5	6,99	9,5	1,5	173	161,85	161,85	173	-	OR 159.5x6.99-N70
161,9	6,99	9,5	1,5	175,3	164,15	164,15	175,3	-	OR 161.9x6.99-N70
164,1	8,4	11	1	180	165	165,00	180	-	OR 164.1x8.4-N70
164,3	5,7	6,4	1	175	165,4	165,00	174,6	-	OR 164.3x5.7-N70

## 6.1 OR O-rings in static radial sealing, metric sizes

ID 164,47 – 240,89 mm

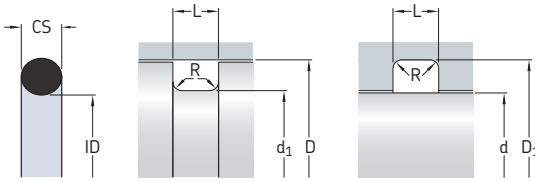

SKF recommends designing O-ring housings according to ISO 3601.  
This table is a reference to O-ring sizes for common housing dimensions.

O-ring dimensions		Housing dimensions						Dash-number	Designation
ID	CS	Outside groove				Inside groove			
		L +0,2	R max.	D H8	d <sub>1</sub> h11	d h7	D <sub>1</sub> H11		
mm		mm						-	-
164,47	6,99	9,5	1,5	177,9	166,75	166,75	177,9	439	OR 164.47x6.99-N70
164,69	3,53	4,8	1	-	-	165,00	170,71	260	OR 164.69x3.53-N70
166,7	6,99	9,5	1,5	180,2	169,05	169,05	180,2	-	OR 166.7x6.99-N70
168,3	6,99	9,5	1,5	181,8	170,65	170,65	181,8	-	OR 168.3x6.99-N70
169,1	8,4	11	1	185	170	170,00	185	-	OR 169.1x8.4-N70
169,3	5,7	6,4	1	180	170,4	170,00	179,6	-	OR 169.3x5.7-N70
170,8	6,99	9,5	1,5	184,2	173,05	173,05	184,2	440	OR 170.8x6.99-N70
171,04	3,53	4,8	1	-	-	171,35	177,06	261	OR 171.04x3.53-N70
174,1	8,4	9	1	190	175	175,00	190	-	OR 174.1x8.4-N70
174,3	5,7	6,4	1	185	175,4	175,00	184,6	-	OR 174.3x5.7-N70
174,6	6,99	9,5	1,5	188,2	177,05	177,05	188,2	-	OR 174.6x6.99-N70
177,17	6,99	9,5	1,5	190,6	179,45	179,45	190,6	441	OR 177.17x6.99-N70
177,39	3,53	4,8	1	-	-	177,70	183,41	262	OR 177.39x3.53-N70
179,1	8,4	9	1	195	180	180,00	195	-	OR 179.1x8.4-N70
179,3	5,7	6,4	1	190	180,4	180,00	189,6	-	OR 179.3x5.7-N70
181	6,99	9,5	1,5	194,5	183,35	183,35	194,5	-	OR 181.0x6.99-N70
183,5	6,99	9,5	1,5	196,9	185,75	185,75	196,9	442	OR 183.5x6.99-N70
183,74	3,53	4,8	1	-	-	184,05	189,76	263	OR 183.74x3.53-N70
184,1	8,4	9	1	200	185	185,00	200	-	OR 184.1x8.4-N70
184,3	5,7	6,4	1	195	185,4	185,00	194,6	-	OR 184.3x5.7-N70
187,3	6,99	9,5	1,5	200,9	189,75	189,75	200,9	-	OR 187.3x6.99-N70

O-ring dimensions		Housing dimensions						Dash-number	Designation
ID	CS	Outside groove			Inside groove				
		L +0,2	R max.	D H8	d <sub>1</sub> h11	d h7	D <sub>1</sub> H11		
mm		mm						-	-
189,1	8,4	9	1	205	190	190,00	205	-	OR 189.1x8.4-N70
189,3	5,7	6,4	1	200	190,4	190,00	199,6	-	OR 189.3x5.7-N70
189,9	6,99	9,5	1,5	203,3	192,15	192,15	203,3	443	OR 189.9x6.99-N70
190,09	3,53	4,8	1	-	-	190,40	196,11	264	OR 190.09x3.53-N70
193,7	6,99	9,5	1,5	207,2	196,05	196,05	207,2	-	OR 193.7x6.99-N70
194,1	8,4	9	1	210	195	195,00	210	-	OR 194.1x8.4-N70
194,3	5,7	6,4	1	205	195,4	195,00	204,6	-	OR 194.3x5.7-N70
196,2	6,99	9,5	1,5	209,6	198,45	198,45	209,6	444	OR 196.2x6.99-N70
196,44	3,53	4,8	1	-	-	196,75	202,46	265	OR 196.44x3.53-N70
199,1	8,4	9	1	215	200	200,00	215	-	OR 199.1x8.4-N70
199,3	5,7	6,4	1	210	200,4	200,00	209,6	-	OR 199.3x5.7-N70
200	6,99	9,5	1,5	213,6	202,45	202,45	213,6	-	OR 200.0x6.99-N70
202,57	6,99	9,5	1,5	216	204,85	204,85	216	445	OR 202.57x6.99-N70
202,79	3,53	4,8	1	-	-	203,10	208,81	266	OR 202.79x3.53-N70
208,9	6,99	9,5	1,5	222,3	211,15	211,15	222,3	-	OR 208.9x6.99-N70
209,1	8,4	9	1	225	210	210,00	225	-	OR 209.1x8.4-N70
209,14	3,53	4,8	1	-	-	209,45	215,16	267	OR 209.14x3.53-N70
209,3	5,7	6,4	1	220	210,4	210,00	219,6	-	OR 209.3x5.7-N70
215,3	6,99	9,5	1,5	228,7	217,55	217,55	228,7	446	OR 215.3x6.99-N70
215,49	3,53	4,8	1	-	-	215,80	221,51	268	OR 215.49x3.53-N70
219,1	8,4	9	1	235	220	220,00	235	-	OR 219.1x8.4-N70
219,3	5,7	6,4	1	230	220,4	220,00	229,6	-	OR 219.3x5.7-N70
221,6	6,99	9,5	1,5	235	223,85	223,82	235	-	OR 221.6x6.99-N70
221,84	3,53	4,8	1	-	-	222,15	227,86	269	OR 221.84x3.53-N70
227,97	6,99	9,5	1,5	241,4	230,25	230,25	241,4	447	OR 227.97x6.99-N70
228,19	3,53	4,8	1	-	-	228,50	234,21	270	OR 228.19x3.53-N70
229,1	8,4	9	1	245	230	230,00	245	-	OR 229.1x8.4-N70
229,3	5,7	6,4	1	240	230,4	230,00	239,6	-	OR 229.3x5.7-N70
234,3	6,99	9,5	1,5	247,7	236,55	236,55	247,7	-	OR 234.3x6.99-N70
234,54	3,53	4,8	1	-	-	234,85	240,56	271	OR 234.54x3.53-N70
239,1	8,4	9	1	255	240	240,00	255	-	OR 239.1x8.4-N70
239,3	5,7	6,4	1	250	240,4	240,00	249,6	-	OR 239.3x5.7-N70
240,67	6,99	9,5	1,5	254,1	242,95	242,95	254,1	448	OR 240.67x6.99-N70
240,89	3,53	4,8	1	-	-	241,20	246,91	272	OR 240.89x3.53-N70

## 6.1 OR O-rings in static radial sealing, metric sizes

ID 247 – 499,3 mm

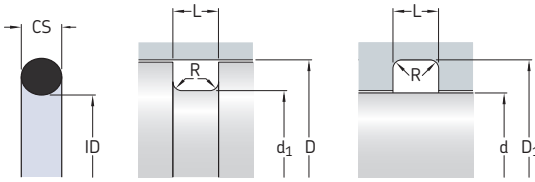

SKF recommends designing O-ring housings according to ISO 3601.  
This table is a reference to O-ring sizes for common housing dimensions.

O-ring dimensions		Housing dimensions						Dash-number	Designation
ID	CS	Outside groove				Inside groove			
mm	mm	L +0,2	R max.	D H8	d <sub>1</sub> h11	d h7	D <sub>1</sub> H11	-	-
247	6,99	9,5	1,5	260,4	249,25	249,25	260,4	-	OR 247.0x6.99-N70
247,25	3,53	4,8	1	-	-	247,55	253,26	273	OR 247.25x3.53-N70
249,1	8,4	9	1	265	250	250,00	265	-	OR 249.1x8.4-N70
249,3	5,7	6,4	1	260	250,4	250,00	259,6	-	OR 249.3x5.7-N70
253,3	6,99	9,5	1,5	266,8	255,65	255,65	266,8	449	OR 253.3x6.99-N70
253,59	3,53	4,8	1	-	-	253,90	259,61	274	OR 253.59x3.53-N70
259,3	5,7	6,4	1	270	260,4	260,00	269,6	-	OR 259.3x5.7-N70
259,7	6,99	9,5	1,5	273,1	261,95	261,95	273,1	-	OR 259.7x6.99-N70
266,07	6,99	9,5	1,5	279,5	268,35	268,35	279,5	450	OR 266.07x6.99-N70
269,3	5,7	6,4	1	280	270,4	270,00	279,6	-	OR 269.3x5.7-N70
272,4	6,99	9,5	1,5	285,8	274,65	274,65	285,8	-	OR 272.4x6.99-N70
278,77	6,99	9,5	1,5	292,2	281,05	281,05	292,2	451	OR 278.77x6.99-N70
279,3	5,7	6,4	1	290	280,4	280,00	289,6	-	OR 279.3x5.7-N70
285,1	6,99	9,5	1,5	298,5	287,35	287,35	298,5	-	OR 285.1x6.99-N70
289,3	5,7	6,4	1	300	290,4	290,00	299,6	-	OR 289.3x5.7-N70
291,47	6,99	9,5	1,5	304,9	293,75	293,75	304,9	452	OR 291.47x6.99-N70
297,8	6,99	9,5	1,5	311,2	300,05	300,05	311,2	-	OR 297.8x6.99-N70
299,3	5,7	6,4	1	310	300,4	300,00	309,6	-	OR 299.3x5.7-N70
304,1	6,99	9,5	1,5	317,6	306,45	306,45	317,6	453	OR 304.1x6.99-N70
316,9	6,99	9,5	1,5	330,3	319,15	319,15	330,3	454	OR 316.9x6.99-N70
319,3	5,7	6,4	1	330	320,4	320,00	329,6	-	OR 319.3x5.7-N70

O-ring dimensions		Housing dimensions						Dash-number	Designation
ID	CS	L +0,2	R max.	Outside groove		Inside groove			
mm				mm	D H8	d <sub>1</sub> h11	d h7	D <sub>1</sub> H11	-
329,5	6,99	9,5	1,5	343	331,85	331,85	343	455	OR 329.5x6.99-N70
339,3	5,7	6,4	1	350	340,4	340,00	349,6	-	OR 339.3x5.7-N70
342,27	6,99	9,5	1,5	355,7	344,55	344,55	355,7	456	OR 342.27x6.99-N70
355	6,99	9,5	1,5	368,4	357,25	357,25	368,4	457	OR 355.0x6.99-N70
359,3	5,7	6,4	1	370	360,4	360,00	369,6	-	OR 359.3x5.7-N70
367,7	6,99	9,5	1,5	381,1	369,95	369,95	381,1	458	OR 367.7x6.99-N70
379,3	5,7	6,4	1	390	380,4	380,00	389,6	-	OR 379.3x5.7-N70
380,37	6,99	9,5	1,5	393,8	382,65	382,65	393,8	459	OR 380.3x6.99-N70
393,1	6,99	9,5	1,5	406,5	395,35	395,35	406,5	460	OR 393.1x6.99-N70
399,3	5,7	6,4	1	410	400,4	400,00	409,6	-	OR 399.3x5.7-N70
419,3	5,7	6,4	1	430	420,4	420,00	429,6	-	OR 419.3x5.7-N70
439,3	5,7	6,4	1	450	440,4	440,00	449,6	-	OR 439.3x5.7-N70
459,3	5,7	6,4	1	470	460,4	460,00	469,6	-	OR 459.3x5.7-N70
479,3	5,7	6,4	1	490	480,4	480,00	489,6	-	OR 479.3x5.7-N70
499,3	5,7	6,4	1	510	500,4	500,00	509,6	-	OR 499.3x5.7-N70

Other sizes are available on request

## 6.2 OR O-rings in static radial sealing, inch sizes

Dash-number 004 – 155

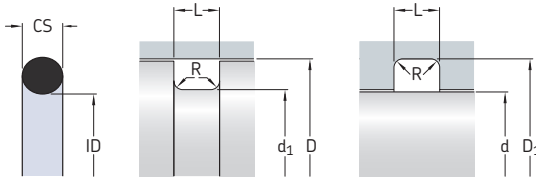

SKF recommends designing O-ring housings according to ISO 3601.  
This table is a reference to O-ring sizes for common housing dimensions.

Dash-number	O-ring dimensions		Housing dimensions		Outside groove		Inside groove		Designation
	CS	ID	L +0.008	R max.	D +0.002	d <sub>1</sub> -0.002	d -0.002	D <sub>1</sub> +0.002	
-	in.		in.						-
004	0.07	0.07	0.093	0.02	0.206	0.106	0.081	0.181	OR 1.78x1.78-N70
005	0.07	0.101	0.093	0.02	0.237	0.137	0.112	0.212	OR 2.57x1.78-N70
006	0.07	0.114	0.093	0.02	0.25	0.15	0.125	0.225	OR 2.90x1.78-N70
007	0.07	0.145	0.093	0.02	0.281	0.181	0.156	0.256	OR 3.69x1.78-N70
008	0.07	0.176	0.093	0.02	0.312	0.212	0.187	0.287	OR 4.48x1.78-N70
009	0.07	0.208	0.093	0.02	0.343	0.243	0.218	0.318	OR 5.28x1.78-N70
010	0.07	0.239	0.093	0.02	0.375	0.275	0.25	0.35	OR 6.07x1.78-N70
011	0.07	0.301	0.093	0.02	0.437	0.337	0.312	0.412	OR 7.65x1.78-N70
012	0.07	0.364	0.093	0.02	0.5	0.4	0.375	0.475	OR 9.25x1.78-N70
013	0.07	0.426	0.093	0.02	0.562	0.462	0.437	0.537	OR 10.82x1.78-N70
014	0.07	0.489	0.093	0.02	0.625	0.525	0.5	0.6	OR 12.42x1.78-N70
015	0.07	0.551	0.093	0.02	0.687	0.587	0.562	0.662	OR 14.0x1.78-N70
016	0.07	0.614	0.093	0.02	0.75	0.65	0.625	0.725	OR 15.6x1.78-N70
017	0.07	0.676	0.093	0.02	0.812	0.712	0.687	0.787	OR 17.17x1.78-N70
018	0.07	0.739	0.093	0.02	0.875	0.775	0.75	0.85	OR 18.77x1.78-N70
019	0.07	0.801	0.093	0.02	0.937	0.837	0.812	0.912	OR 20.35x1.78-N70
020	0.07	0.864	0.093	0.02	1	0.9	0.875	0.975	OR 21.95x1.78-N70
021	0.07	0.926	0.093	0.02	1.062	0.962	0.937	1.037	OR 23.52x1.78-N70
022	0.07	0.989	0.093	0.02	1.125	1.025	1	1.1	OR 25.12x1.78-N70
023	0.07	1.051	0.093	0.02	1.187	1.087	1.062	1.162	OR 26.7x1.78-N70
024	0.07	1.114	0.093	0.02	1.25	1.15	1.125	1.225	OR 28.3x1.78-N70
025	0.07	1.176	0.093	0.02	1.312	1.212	1.187	1.287	OR 29.87x1.78-N70
026	0.07	1.239	0.093	0.02	1.375	1.275	1.25	1.35	OR 31.47x1.78-N70
027	0.07	1.301	0.093	0.02	1.437	1.337	1.312	1.412	OR 33.05x1.78-N70
028	0.07	1.364	0.093	0.02	1.5	1.4	1.375	1.475	OR 34.65x1.78-N70
029	0.07	1.489	0.093	0.02	1.625	1.525	1.5	1.6	OR 37.82x1.78-N70
030	0.07	1.614	0.093	0.02	1.75	1.65	1.625	1.725	OR 41.0x1.78-N70
031	0.07	1.739	0.093	0.02	1.875	1.775	1.75	1.85	OR 44.17x1.78-N70
032	0.07	1.864	0.093	0.02	2	1.9	1.875	1.975	OR 47.35x1.78-N70
033	0.07	1.989	0.093	0.02	2.125	2.025	2	2.1	OR 50.52x1.78-N70
034	0.07	2.114	0.093	0.02	2.25	2.15	2.125	2.225	OR 53.7x1.78-N70
035	0.07	2.239	0.093	0.02	2.375	2.275	2.25	2.35	OR 56.87x1.78-N70
036	0.07	2.364	0.093	0.02	2.5	2.4	2.375	2.475	OR 60.04x1.78-N70
037	0.07	2.489	0.093	0.02	2.625	2.525	2.5	2.6	OR 63.22x1.78-N70
038	0.07	2.614	0.093	0.02	2.75	2.65	2.625	2.725	OR 66.4x1.78-N70
039	0.07	2.739	0.093	0.02	2.875	2.775	2.75	2.85	OR 69.57x1.78-N70

Dash-number	O-ring dimensions		Housing dimensions				Outside groove		Inside groove		Designation
	CS	ID	L +0.008	R max.	D +0.002	d <sub>1</sub> -0.002	d -0.002	D <sub>1</sub> +0.002			
									in.		
040	0.07	2.864	0.093	0.02	3	2.9	2.875	2.975	OR 72.75x1.78-N70		
041	0.07	2.989	0.093	0.02	3.125	3.025	3	3.1	OR 75.92x1.78-N70		
042	0.07	3.239	0.093	0.02	3.375	3.275	3.25	3.35	OR 82.27x1.78-N70		
043	0.07	3.489	0.093	0.02	3.625	3.525	3.5	3.6	OR 88.62x1.78-N70		
044	0.07	3.739	0.093	0.02	3.875	3.775	3.75	3.85	OR 94.97x1.78-N70		
045	0.07	3.99	0.093	0.02	4.125	4.025	4	4.1	OR 101.34x1.78-N70		
046	0.07	4.239	0.093	0.02	4.375	4.275	4.25	4.35	OR 107.67x1.78-N70		
047	0.07	4.489	0.093	0.02	4.625	4.525	4.5	4.6	OR 114.02x1.78-N70		
048	0.07	4.739	0.093	0.02	4.875	4.775	4.75	4.85	OR 120.37x1.78-N70		
049	0.07	4.989	0.093	0.02	5.125	5.025	5	5.1	OR 126.72x1.78-N70		
050	0.07	5.239	0.093	0.02	5.375	5.275	5.25	5.35	OR 133.07x1.78-N70		
106	0.103	0.174	0.14	0.03	0.374	0.212	0.187	0.349	OR 4.42x2.62-N70		
107	0.103	0.206	0.14	0.03	0.405	0.243	0.219	0.381	OR 5.23x2.62-N70		
109	0.103	0.299	0.14	0.03	0.5	0.338	0.312	0.474	OR 7.59x2.62-N70		
110	0.103	0.362	0.14	0.03	0.562	0.4	0.375	0.537	OR 9.19x2.62-N70		
111	0.103	0.424	0.14	0.03	0.625	0.463	0.437	0.599	OR 10.78x2.62-N70		
112	0.103	0.487	0.14	0.03	0.687	0.525	0.5	0.662	OR 12.37x2.62-N70		
113	0.103	0.549	0.14	0.03	0.75	0.588	0.563	0.725	OR 13.94x2.62-N70		
114	0.103	0.612	0.14	0.03	0.812	0.65	0.625	0.787	OR 15.54x2.62-N70		
115	0.103	0.674	0.14	0.03	0.875	0.713	0.688	0.85	OR 17.12x2.62-N70		
116	0.103	0.737	0.14	0.03	0.937	0.775	0.75	0.912	OR 18.72x2.62-N70		
117	0.103	0.799	0.14	0.03	1	0.838	0.813	0.975	OR 20.29x2.62-N70		
118	0.103	0.862	0.14	0.03	1.062	0.9	0.875	1.037	OR 21.89x2.62-N70		
119	0.103	0.924	0.14	0.03	1.125	0.963	0.938	1.1	OR 23.47x2.62-N70		
120	0.103	0.987	0.14	0.03	1.187	1.025	1	1.162	OR 25.07x2.62-N70		
121	0.103	1.049	0.14	0.03	1.25	1.088	1.062	1.224	OR 26.64x2.62-N70		
123	0.103	1.174	0.14	0.03	1.375	1.213	1.187	1.349	OR 29.82x2.62-N70		
124	0.103	1.237	0.14	0.03	1.437	1.275	1.25	1.412	OR 31.42x2.62-N70		
125	0.103	1.299	0.14	0.03	1.5	1.338	1.312	1.474	OR 32.99x2.62-N70		
126	0.103	1.362	0.14	0.03	1.562	1.4	1.375	1.537	OR 34.59x2.62-N70		
127	0.103	1.424	0.14	0.03	1.625	1.463	1.437	1.599	OR 36.17x2.62-N70		
128	0.103	1.487	0.14	0.03	1.687	1.525	1.5	1.662	OR 37.77x2.62-N70		
129	0.103	1.549	0.14	0.03	1.75	1.588	1.562	1.724	OR 39.34x2.62-N70		
130	0.103	1.612	0.14	0.03	1.812	1.65	1.625	1.787	OR 40.95x2.62-N70		
131	0.103	1.674	0.14	0.03	1.875	1.713	1.687	1.849	OR 42.52x2.62-N70		
132	0.103	1.737	0.14	0.03	1.937	1.775	1.75	1.912	OR 44.12x2.62-N70		
133	0.103	1.799	0.14	0.03	2	1.838	1.812	1.974	OR 45.69x2.62-N70		
134	0.103	1.862	0.14	0.03	2.062	1.9	1.875	2.037	OR 47.29x2.62-N70		
135	0.103	1.925	0.14	0.03	2.125	1.963	1.937	2.099	OR 48.9x2.62-N70		
136	0.103	1.987	0.14	0.03	2.187	2.025	2	2.162	OR 50.47x2.62-N70		
137	0.103	2.05	0.14	0.03	2.25	2.088	2.062	2.224	OR 52.07x2.62-N70		
138	0.103	2.112	0.14	0.03	2.312	2.15	2.125	2.287	OR 53.64x2.62-N70		
139	0.103	2.175	0.14	0.03	2.375	2.213	2.187	2.349	OR 55.25x2.62-N70		
140	0.103	2.237	0.14	0.03	2.437	2.275	2.25	2.412	OR 56.82x2.62-N70		
141	0.103	2.3	0.14	0.03	2.5	2.338	2.312	2.474	OR 58.42x2.62-N70		
142	0.103	2.362	0.14	0.03	2.562	2.4	2.375	2.537	OR 60.0x2.62-N70		
143	0.103	2.425	0.14	0.03	2.625	2.463	2.437	2.599	OR 61.6x2.62-N70		
144	0.103	2.487	0.14	0.03	2.687	2.525	2.5	2.662	OR 63.17x2.62-N70		
145	0.103	2.55	0.14	0.03	2.75	2.588	2.562	2.724	OR 64.77x2.62-N70		
146	0.103	2.612	0.14	0.03	2.812	2.65	2.625	2.787	OR 66.34x2.62-N70		
147	0.103	2.675	0.14	0.03	2.875	2.713	2.687	2.849	OR 67.94x2.62-N70		
148	0.103	2.737	0.14	0.03	2.937	2.775	2.75	2.912	OR 69.52x2.62-N70		
149	0.103	2.8	0.14	0.03	3	2.838	2.812	2.974	OR 71.12x2.62-N70		
150	0.103	2.862	0.14	0.03	3.062	2.9	2.937	3.099	OR 72.7x2.62-N70		
151	0.103	2.987	0.14	0.03	3.187	3.025	3	3.162	OR 75.87x2.62-N70		
152	0.103	3.237	0.14	0.03	3.437	3.275	3.25	3.412	OR 82.22x2.62-N70		
153	0.103	3.487	0.14	0.03	3.687	3.525	3.5	3.662	OR 88.57x2.62-N70		
154	0.103	3.737	0.14	0.03	3.937	3.775	3.75	3.912	OR 94.92x2.62-N70		
155	0.103	3.987	0.14	0.03	4.187	4.025	4	4.162	OR 101.27x2.62-N70		



## 6.2 OR O-rings in static radial sealing, inch sizes

Dash-number 156 – 274

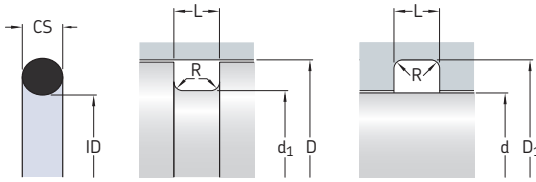

SKF recommends designing O-ring housings according to ISO 3601.  
This table is a reference to O-ring sizes for common housing dimensions.

Dash-number	O-ring dimensions		Housing dimensions				Designation		
	CS	ID	L +0.008	R max.	Outside groove		Inside groove		
					D +0.002	d <sub>1</sub> -0.002	d -0.002	D <sub>1</sub> +0.002	
-	in.		in.						-
156	0.103	4.237	0.14	0.03	4.437	4.275	4.25	4.412	OR 107.62x2.62-N70
157	0.103	4.487	0.14	0.03	4.687	4.525	4.5	4.662	OR 113.97x2.62-N70
158	0.103	4.737	0.14	0.03	4.937	4.775	4.75	4.912	OR 120.32x2.62-N70
159	0.103	4.987	0.14	0.03	5.187	5.025	5	5.162	OR 126.67x2.62-N70
160	0.103	5.237	0.14	0.03	5.437	5.275	5.25	5.412	OR 133.02x2.62-N70
161	0.103	5.487	0.14	0.03	5.687	5.525	5.5	5.662	OR 139.37x2.62-N70
162	0.103	5.737	0.14	0.03	5.937	5.775	5.75	5.912	OR 145.72x2.62-N70
163	0.103	5.987	0.14	0.03	6.187	6.025	6	6.162	OR 152.07x2.62-N70
164	0.103	6.237	0.14	0.03	6.437	6.275	6.25	6.412	OR 158.42x2.62-N70
165	0.103	6.487	0.14	0.03	6.687	6.525	6.5	6.662	OR 164.77x2.62-N70
166	0.103	6.737	0.14	0.03	6.937	6.775	6.75	6.912	OR 171.12x2.62-N70
167	0.103	6.987	0.14	0.03	7.187	7.025	7	7.162	OR 177.47x2.62-N70
168	0.103	7.237	0.14	0.03	7.437	7.275	7.25	7.412	OR 183.82x2.62-N70
169	0.103	7.487	0.14	0.03	7.687	7.525	7.5	7.662	OR 190.17x2.62-N70
170	0.103	7.737	0.14	0.03	7.937	7.775	7.75	7.912	OR 196.52x2.62-N70
171	0.103	7.987	0.14	0.03	8.187	8.025	8	8.162	OR 202.87x2.62-N70
172	0.103	8.237	0.14	0.03	8.437	8.275	8.25	8.412	OR 209.22x2.62-N70
173	0.103	8.487	0.14	0.03	8.687	8.525	8.5	8.662	OR 215.57x2.62-N70
174	0.103	8.737	0.14	0.03	8.937	8.775	8.75	8.912	OR 221.92x2.62-N70
175	0.103	8.987	0.14	0.03	9.187	9.025	9	9.162	OR 228.27x2.62-N70
176	0.103	9.237	0.14	0.03	9.437	9.275	9.25	9.412	OR 234.62x2.62-N70
177	0.103	9.487	0.14	0.03	9.687	9.525	9.5	9.662	OR 240.97x2.62-N70
178	0.103	9.737	0.14	0.03	9.937	9.775	9.75	9.912	OR 247.32x2.62-N70
205	0.139	0.421	0.187	0.04	0.687	0.465	0.437	0.659	OR 10.69x3.53-N70
206	0.139	0.484	0.187	0.04	0.75	0.528	0.5	0.722	OR 12.29x3.53-N70
207	0.139	0.546	0.187	0.04	0.812	0.59	0.562	0.784	OR 13.87x3.53-N70
208	0.139	0.609	0.187	0.04	0.875	0.653	0.625	0.847	OR 15.47x3.53-N70
209	0.139	0.671	0.187	0.04	0.937	0.715	0.687	0.909	OR 17.04x3.53-N70
210	0.139	0.734	0.187	0.04	1	0.778	0.75	0.972	OR 18.64x3.53-N70
211	0.139	0.796	0.187	0.04	1.062	0.84	0.812	1.034	OR 20.22x3.53-N70
212	0.139	0.859	0.187	0.04	1.125	0.903	0.875	1.097	OR 21.82x3.53-N70
213	0.139	0.921	0.187	0.04	1.187	0.965	0.937	1.159	OR 23.4x3.53-N70
214	0.139	0.984	0.187	0.04	1.25	1.028	1	1.222	OR 24.99x3.53-N70
215	0.139	1.046	0.187	0.04	1.312	1.09	1.062	1.284	OR 26.58x3.53-N70
216	0.139	1.109	0.187	0.04	1.375	1.153	1.125	1.347	OR 28.17x3.53-N70



Dash-number	O-ring dimensions		Housing dimensions		Outside groove		Inside groove		Designation
	CS	ID	L +0.008	R max.	D +0.002	d <sub>1</sub> -0.002	d -0.002	D <sub>1</sub> +0.002	
217	0.139	1.171	0.187	0.04	1.437	1.215	1.187	1.409	OR 29.74x3.53-N70
218	0.139	1.234	0.187	0.04	1.5	1.278	1.25	1.472	OR 31.34x3.53-N70
219	0.139	1.296	0.187	0.04	1.562	1.34	1.312	1.534	OR 32.92x3.53-N70
220	0.139	1.359	0.187	0.04	1.625	1.403	1.375	1.597	OR 34.52x3.53-N70
221	0.139	1.421	0.187	0.04	1.687	1.465	1.437	1.659	OR 36.1x3.53-N70
222	0.139	1.484	0.187	0.04	1.75	1.528	1.5	1.722	OR 37.69x3.53-N70
223	0.139	1.609	0.187	0.04	1.875	1.653	1.625	1.847	OR 40.87x3.53-N70
224	0.139	1.734	0.187	0.04	2	1.778	1.75	1.972	OR 44.04x3.53-N70
225	0.139	1.859	0.187	0.04	2.125	1.903	1.875	2.097	OR 47.22x3.53-N70
226	0.139	1.984	0.187	0.04	2.25	2.028	2	2.222	OR 50.4x3.53-N70
227	0.139	2.109	0.187	0.04	2.375	2.153	2.125	2.347	OR 53.56x3.53-N70
228	0.139	2.234	0.187	0.04	2.5	2.278	2.25	2.472	OR 56.74x3.53-N70
229	0.139	2.359	0.187	0.04	2.625	2.403	2.375	2.597	OR 59.92x3.53-N70
230	0.139	2.484	0.187	0.04	2.75	2.528	2.5	2.722	OR 63.09x3.53-N70
231	0.139	2.609	0.187	0.04	2.875	2.653	2.625	2.847	OR 66.27x3.53-N70
232	0.139	2.734	0.187	0.04	3	2.778	2.75	2.972	OR 69.44x3.53-N70
233	0.139	2.859	0.187	0.04	3.125	2.903	2.875	3.097	OR 72.62x3.53-N70
234	0.139	2.984	0.187	0.04	3.25	3.028	3	3.222	OR 75.79x3.53-N70
235	0.139	3.109	0.187	0.04	3.375	3.153	3.125	3.347	OR 78.97x3.53-N70
236	0.139	3.234	0.187	0.04	3.5	3.278	3.25	3.472	OR 82.14x3.53-N70
237	0.139	3.359	0.187	0.04	3.625	3.403	3.375	3.597	OR 85.32x3.53-N70
238	0.139	3.484	0.187	0.04	3.75	3.528	3.5	3.722	OR 88.49x3.53-N70
239	0.139	3.609	0.187	0.04	3.875	3.653	3.625	3.847	OR 91.67x3.53-N70
240	0.139	3.734	0.187	0.04	4	3.778	3.75	3.972	OR 94.84x3.53-N70
241	0.139	3.859	0.187	0.04	4.125	3.903	3.875	4.097	OR 98.02x3.53-N70
242	0.139	3.984	0.187	0.04	4.25	4.028	4	4.222	OR 101.19x3.53-N70
243	0.139	4.109	0.187	0.04	4.375	4.153	4.125	4.347	OR 104.37x3.53-N70
244	0.139	4.234	0.187	0.04	4.5	4.278	4.25	4.472	OR 107.54x3.53-N70
245	0.139	4.359	0.187	0.04	4.625	4.403	4.375	4.597	OR 110.72x3.53-N70
246	0.139	4.484	0.187	0.04	4.75	4.528	4.5	4.722	OR 113.89x3.53-N70
247	0.139	4.609	0.187	0.04	4.875	4.653	4.625	4.847	OR 117.07x3.53-N70
248	0.139	4.734	0.187	0.04	5	4.778	4.75	4.972	OR 120.24x3.53-N70
249	0.139	4.859	0.187	0.04	5.125	4.903	4.875	5.097	OR 123.42x3.53-N70
250	0.139	4.984	0.187	0.04	5.25	5.028	5	5.222	OR 126.59x3.53-N70
251	0.139	5.109	0.187	0.04	5.375	5.153	5.125	5.347	OR 129.77x3.53-N70
252	0.139	5.234	0.187	0.04	5.5	5.278	5.25	5.472	OR 132.94x3.53-N70
253	0.139	5.359	0.187	0.04	5.625	5.403	5.375	5.597	OR 136.12x3.53-N70
254	0.139	5.484	0.187	0.04	5.75	5.528	5.5	5.722	OR 139.29x3.53-N70
255	0.139	5.609	0.187	0.04	5.875	5.653	5.625	5.847	OR 142.47x3.53-N70
256	0.139	5.734	0.187	0.04	6	5.778	5.75	5.972	OR 145.64x3.53-N70
257	0.139	5.859	0.187	0.04	6.125	5.903	5.875	6.097	OR 148.82x3.53-N70
258	0.139	5.984	0.187	0.04	6.25	6.028	6	6.222	OR 151.99x3.53-N70
259	0.139	6.234	0.187	0.04	6.5	6.278	6.25	6.472	OR 158.34x3.53-N70
260	0.139	6.484	0.187	0.04	6.75	6.528	6.5	6.722	OR 164.69x3.53-N70
261	0.139	6.734	0.187	0.04	7	6.778	6.75	6.972	OR 171.04x3.53-N70
262	0.139	6.984	0.187	0.04	7.25	7.028	7	7.222	OR 177.39x3.53-N70
263	0.139	7.234	0.187	0.04	7.5	7.278	7.25	7.472	OR 183.74x3.53-N70
264	0.139	7.484	0.187	0.04	7.75	7.528	7.5	7.722	OR 190.09x3.53-N70
265	0.139	7.734	0.187	0.04	8	7.778	7.75	7.972	OR 196.44x3.53-N70
266	0.139	7.984	0.187	0.04	8.25	8.028	8	8.222	OR 202.79x3.53-N70
267	0.139	8.234	0.187	0.04	8.5	8.278	8.25	8.472	OR 209.14x3.53-N70
268	0.139	8.484	0.187	0.04	8.75	8.528	8.5	8.722	OR 215.49x3.53-N70
269	0.139	8.734	0.187	0.04	9	8.778	8.75	8.972	OR 221.84x3.53-N70
270	0.139	8.984	0.187	0.04	9.25	9.028	9	9.222	OR 228.19x3.53-N70
271	0.139	9.234	0.187	0.04	9.5	9.278	9.25	9.472	OR 234.54x3.53-N70
272	0.139	9.484	0.187	0.04	9.75	9.528	9.5	9.722	OR 240.89x3.53-N70
273	0.139	9.734	0.187	0.04	10	9.778	9.75	9.972	OR 247.25x3.53-N70
274	0.139	9.984	0.187	0.04	10.25	10.028	10	10.222	OR 253.59x3.53-N70



## 6.2 OR O-rings in static radial sealing, inch sizes

Dash-number 275 – 374

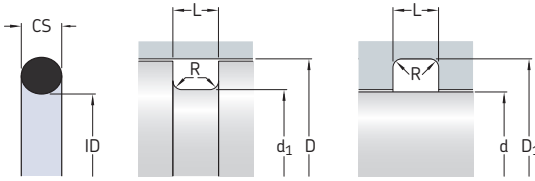

SKF recommends designing O-ring housings according to ISO 3601.  
This table is a reference to O-ring sizes for common housing dimensions.

Dash-number	O-ring dimensions		Housing dimensions				Designation		
	CS	ID	L +0.008	R max.	Outside groove		Inside groove		
					D +0.002	d <sub>1</sub> -0.002	d -0.002	D <sub>1</sub> +0.002	
-	in.		in.						-
275	0.139	10.484	0.187	0.04	10.75	10.528	10.5	10.722	OR 266.29x3.53-N70
276	0.139	10.984	0.187	0.04	11.25	11.028	11	11.222	OR 279.0x3.53-N70
277	0.139	11.484	0.187	0.04	11.75	11.528	11.5	11.722	OR 291.69x3.53-N70
278	0.139	11.984	0.187	0.04	12.25	12.028	12	12.222	OR 304.39x3.53-N70
279	0.139	12.984	0.187	0.04	13.25	13.028	13	13.222	OR 329.79x3.53-N70
280	0.139	13.984	0.187	0.04	14.25	14.028	14	14.222	OR 355.19x3.53-N70
281	0.139	14.984	0.187	0.04	15.25	15.028	15	15.222	OR 380.59x3.53-N70
282	0.139	15.955	0.187	0.04	16.25	16.028	16	16.222	OR 405.26x3.53-N70
283	0.139	16.955	0.187	0.04	17.25	17.028	17	17.222	OR 430.66x3.53-N70
284	0.139	17.955	0.187	0.04	18.25	18.028	18	18.222	OR 456.06x3.53-N70

Dash-number	O-ring dimensions		Housing dimensions				Designation		
	CS	ID	L +0.008	R max.	Outside groove		Inside groove		
					D +0.004	d <sub>1</sub> -0.004	d -0.002	D <sub>1</sub> +0.004	
-	in.	in.	in.	in.	in.	in.	in.	-	
314	0.21	0.725	0.281	0.04	1.125	0.785	0.75	1.09	OR 18.42x5.33-N70
316	0.21	0.85	0.281	0.04	1.25	0.91	0.875	1.215	OR 21.59x5.33-N70
317	0.21	0.912	0.281	0.04	1.312	0.972	0.937	1.277	OR 23.16x5.33-N70
318	0.21	0.975	0.281	0.04	1.375	1.035	1	1.34	OR 24.77x5.33-N70
319	0.21	1.037	0.281	0.04	1.437	1.097	1.062	1.402	OR 26.34x5.33-N70
320	0.21	1.1	0.281	0.04	1.5	1.16	1.125	1.465	OR 27.94x5.33-N70
321	0.21	1.162	0.281	0.04	1.562	1.222	1.187	1.527	OR 29.51x5.33-N70
322	0.21	1.225	0.281	0.04	1.625	1.285	1.25	1.59	OR 31.12x5.33-N70
323	0.21	1.287	0.281	0.04	1.687	1.347	1.312	1.652	OR 32.69x5.33-N70
324	0.21	1.35	0.281	0.04	1.75	1.41	1.375	1.715	OR 34.29x5.33-N70
325	0.21	1.475	0.281	0.04	1.875	1.535	1.5	1.84	OR 37.47x5.33-N70
326	0.21	1.6	0.281	0.04	2	1.66	1.625	1.965	OR 40.65x5.33-N70
327	0.21	1.725	0.281	0.04	2.125	1.785	1.75	2.09	OR 43.82x5.33-N70
328	0.21	1.85	0.281	0.04	2.25	1.91	1.875	2.215	OR 46.99x5.33-N70
329	0.21	1.975	0.281	0.04	2.375	2.035	2	2.34	OR 50.16x5.33-N70
330	0.21	2.1	0.281	0.04	2.5	2.16	2.125	2.465	OR 53.34x5.33-N70
331	0.21	2.225	0.281	0.04	2.625	2.285	2.25	2.59	OR 56.52x5.33-N70
332	0.21	2.35	0.281	0.04	2.75	2.41	2.375	2.715	OR 59.69x5.33-N70
333	0.21	2.475	0.281	0.04	2.875	2.535	2.5	2.84	OR 62.87x5.33-N70
334	0.21	2.6	0.281	0.04	3	2.66	2.625	2.965	OR 66.04x5.33-N70
335	0.21	2.725	0.281	0.04	3.125	2.785	2.75	3.09	OR 69.22x5.33-N70
336	0.21	2.85	0.281	0.04	3.25	2.91	2.875	3.215	OR 72.39x5.33-N70
337	0.21	2.975	0.281	0.04	3.375	3.035	3	3.34	OR 75.57x5.33-N70
338	0.21	3.1	0.281	0.04	3.5	3.16	3.125	3.465	OR 78.74x5.33-N70
339	0.21	3.225	0.281	0.04	3.625	3.285	3.25	3.59	OR 81.92x5.33-N70
340	0.21	3.35	0.281	0.04	3.75	3.41	3.375	3.715	OR 85.09x5.33-N70
341	0.21	3.475	0.281	0.04	3.875	3.535	3.5	3.84	OR 88.27x5.33-N70
342	0.21	3.6	0.281	0.04	4	3.66	3.625	3.965	OR 91.44x5.33-N70
343	0.21	3.725	0.281	0.04	4.125	3.785	3.75	4.09	OR 94.62x5.33-N70
344	0.21	3.85	0.281	0.04	4.25	3.91	3.875	4.215	OR 97.79x5.33-N70
345	0.21	3.975	0.281	0.04	4.375	4.035	4	4.34	OR 100.97x5.33-N70
346	0.21	4.1	0.281	0.04	4.5	4.16	4.125	4.465	OR 104.14x5.33-N70
347	0.21	4.225	0.281	0.04	4.625	4.285	4.25	4.59	OR 107.32x5.33-N70
348	0.21	4.35	0.281	0.04	4.75	4.41	4.375	4.715	OR 110.49x5.33-N70
349	0.21	4.475	0.281	0.04	4.875	4.535	4.5	4.84	OR 113.67x5.33-N70
350	0.21	4.6	0.281	0.04	5	4.66	4.625	4.965	OR 116.84x5.33-N70
351	0.21	4.725	0.281	0.04	5.125	4.785	4.75	5.09	OR 120.02x5.33-N70
352	0.21	4.85	0.281	0.04	5.25	4.91	4.875	5.215	OR 123.19x5.33-N70
353	0.21	4.975	0.281	0.04	5.375	5.035	5	5.34	OR 126.37x5.33-N70
354	0.21	5.1	0.281	0.04	5.5	5.16	5.125	5.465	OR 129.54x5.33-N70
355	0.21	5.225	0.281	0.04	5.625	5.285	5.25	5.59	OR 132.72x5.33-N70
356	0.21	5.35	0.281	0.04	5.75	5.41	5.375	5.715	OR 135.89x5.33-N70
357	0.21	5.475	0.281	0.04	5.875	5.535	5.5	5.84	OR 139.07x5.33-N70
358	0.21	5.6	0.281	0.04	6	5.66	5.625	5.965	OR 142.24x5.33-N70
359	0.21	5.725	0.281	0.04	6.125	5.785	5.75	6.09	OR 145.42x5.33-N70
360	0.21	5.85	0.281	0.04	6.25	5.91	5.875	6.215	OR 148.59x5.33-N70
361	0.21	5.975	0.281	0.04	6.375	6.035	6	6.34	OR 151.77x5.33-N70
362	0.21	6.225	0.281	0.04	6.625	6.285	6.25	6.59	OR 158.12x5.33-N70
363	0.21	6.475	0.281	0.04	6.875	6.535	6.5	6.84	OR 164.47x5.33-N70
364	0.21	6.725	0.281	0.04	7.125	6.785	6.75	7.09	OR 170.82x5.33-N70
365	0.21	6.975	0.281	0.04	7.375	7.035	7	7.34	OR 177.17x5.33-N70
366	0.21	7.225	0.281	0.04	7.625	7.285	7.25	7.59	OR 183.52x5.33-N70
367	0.21	7.475	0.281	0.04	7.875	7.535	7.5	7.84	OR 189.87x5.33-N70
368	0.21	7.725	0.281	0.04	8.125	7.785	7.75	8.09	OR 196.22x5.33-N70
369	0.21	7.975	0.281	0.04	8.375	8.035	8	8.34	OR 202.57x5.33-N70
370	0.21	8.225	0.281	0.04	8.625	8.285	8.25	8.59	OR 208.92x5.33-N70
371	0.21	8.475	0.281	0.04	8.875	8.535	8.5	8.84	OR 215.27x5.33-N70
372	0.21	8.725	0.281	0.04	9.125	8.785	8.75	9.09	OR 221.62x5.33-N70
373	0.21	8.975	0.281	0.04	9.375	9.035	9	9.34	OR 227.97x5.33-N70
374	0.21	9.225	0.281	0.04	9.625	9.285	9.25	9.59	OR 234.32x5.33-N70

6.2

## 6.2 OR O-rings in static radial sealing, inch sizes

Dash-number 375 – 475

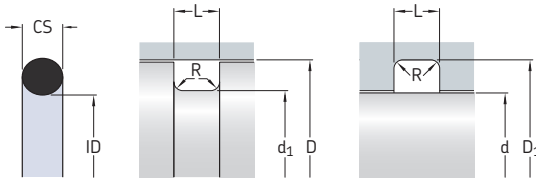

SKF recommends designing O-ring housings according to ISO 3601.  
This table is a reference to O-ring sizes for common housing dimensions.

Dash-number	O-ring dimensions		Housing dimensions		Outside groove		Inside groove		Designation
	CS	ID	L +0.008	R max.	D +0.004	d <sub>1</sub> -0.004	d -0.002	D <sub>1</sub> +0.004	
-	in.		in.						-
375	0.21	9.475	0.281	0.04	9.875	9.535	9.5	9.84	OR 240.67x5.33-N70
376	0.21	9.725	0.281	0.04	10.125	9.785	9.75	10.09	OR 247.02x5.33-N70
377	0.21	9.975	0.281	0.04	10.375	10.035	10	10.34	OR 253.37x5.33-N70
378	0.21	10.475	0.281	0.04	10.875	10.535	10.5	10.84	OR 266.07x5.33-N70
379	0.21	10.975	0.281	0.04	11.375	11.035	11	11.34	OR 278.77x5.33-N70
380	0.21	11.475	0.281	0.04	11.875	11.535	11.5	11.84	OR 291.47x5.33-N70
381	0.21	11.975	0.281	0.04	12.375	12.035	12	12.34	OR 304.17x5.33-N70
382	0.21	12.975	0.281	0.04	13.375	13.035	13	13.34	OR 329.57x5.33-N70
383	0.21	13.975	0.281	0.04	14.375	14.035	14	14.34	OR 354.97x5.33-N70
384	0.21	14.975	0.281	0.04	15.375	15.035	15	15.34	OR 380.37x5.33-N70
385	0.21	15.955	0.281	0.04	16.375	16.035	16	16.34	OR 405.26x5.33-N70
386	0.21	16.955	0.281	0.04	17.375	17.035	17	17.34	OR 430.66x5.33-N70
387	0.21	17.955	0.281	0.04	18.375	18.035	18	18.34	OR 456.06x5.33-N70
388	0.21	18.953	0.281	0.04	19.375	19.035	19	19.34	OR 481.41x5.33-N70
389	0.21	19.953	0.281	0.04	20.375	20.035	20	20.34	OR 506.81x5.33-N70
390	0.21	20.953	0.281	0.04	21.375	21.035	21	21.34	OR 532.21x5.33-N70
391	0.21	21.953	0.281	0.04	22.375	22.035	22	22.34	OR 557.61x5.33-N70
392	0.21	22.94	0.281	0.04	23.375	23.035	23	23.34	OR 582.68x5.33-N70
393	0.21	23.94	0.281	0.04	24.375	24.035	24	24.34	OR 608.08x5.33-N70
394	0.21	24.94	0.281	0.04	25.375	25.035	25	25.34	OR 633.48x5.33-N70
395	0.21	25.94	0.281	0.04	26.375	26.035	26	26.34	OR 658.88x5.33-N70
425	0.275	4.476	0.375	0.06	5	4.548	4.5	4.952	OR 113.7x6.99-N70
426	0.275	4.598	0.375	0.06	5.125	4.673	4.625	5.077	OR 116.8x6.99-N70
427	0.275	4.724	0.375	0.06	5.25	4.798	4.75	5.202	OR 120.0x6.99-N70
428	0.275	4.85	0.375	0.06	5.375	4.923	4.875	5.327	OR 123.19x6.99-N70
429	0.275	4.975	0.375	0.06	5.5	5.048	5	5.452	OR 126.37x6.99-N70
430	0.275	5.1	0.375	0.06	5.625	5.173	5.125	5.577	OR 129.54x6.99-N70
431	0.275	5.224	0.375	0.06	5.75	5.298	5.25	5.702	OR 132.7x6.99-N70
432	0.275	5.35	0.375	0.06	5.875	5.423	5.375	5.827	OR 135.9x6.99-N70
433	0.275	5.475	0.375	0.06	6	5.548	5.5	5.952	OR 139.07x6.99-N70
434	0.275	5.6	0.375	0.06	6.125	5.673	5.625	6.077	OR 142.24x6.99-N70
435	0.275	5.724	0.375	0.06	6.25	5.798	5.75	6.202	OR 145.4x6.99-N70
436	0.275	5.85	0.375	0.06	6.375	5.923	5.875	6.327	OR 148.6x6.99-N70

Dash-number	O-ring dimensions		Housing dimensions		Outside groove		Inside groove		Designation
	CS	ID	L +0.008	R max.	D +0.004	d <sub>1</sub> -0.004	d -0.002	D <sub>1</sub> +0.004	
437	0.275	5.976	0.375	0.06	6.5	6.048	6	6.452	OR 151.8x6.99-N70
438	0.275	6.225	0.375	0.06	6.75	6.298	6.25	6.702	OR 158.12x6.99-N70
439	0.275	6.475	0.375	0.06	7	6.548	6.5	6.952	OR 164.47x6.99-N70
440	0.275	6.724	0.375	0.06	7.25	6.798	6.75	7.202	OR 170.8x6.99-N70
441	0.275	6.975	0.375	0.06	7.5	7.048	7	7.452	OR 177.17x6.99-N70
442	0.275	7.224	0.375	0.06	7.75	7.298	7.25	7.702	OR 183.5x6.99-N70
443	0.275	7.476	0.375	0.06	8	7.548	7.5	7.952	OR 189.9x6.99-N70
444	0.275	7.724	0.375	0.06	8.25	7.798	7.75	8.202	OR 196.2x6.99-N70
445	0.275	7.975	0.375	0.06	8.5	8.048	8	8.452	OR 202.57x6.99-N70
446	0.275	8.476	0.375	0.06	9	8.548	8.5	8.952	OR 215.3x6.99-N70
447	0.275	8.975	0.375	0.06	9.5	9.048	9	9.452	OR 227.97x6.99-N70
448	0.275	9.475	0.375	0.06	10	9.548	9.5	9.952	OR 240.67x6.99-N70
449	0.275	9.972	0.375	0.06	10.5	10.048	10	10.452	OR 253.3x6.99-N70
450	0.275	10.475	0.375	0.06	11	10.548	10.5	10.952	OR 266.07x6.99-N70
451	0.275	10.975	0.375	0.06	11.5	11.048	11	11.452	OR 278.77x6.99-N70
452	0.275	11.475	0.375	0.06	12	11.548	11.5	10.952	OR 291.47x6.99-N70
453	0.275	11.972	0.375	0.06	12.5	12.048	12	12.452	OR 304.1x6.99-N70
454	0.275	12.476	0.375	0.06	13	12.548	12.5	12.952	OR 316.9x6.99-N70
455	0.275	12.972	0.375	0.06	13.5	13.048	13	13.452	OR 329.5x6.99-N70
456	0.275	13.475	0.375	0.06	14	13.548	13.5	13.952	OR 342.27x6.99-N70
457	0.275	13.976	0.375	0.06	14.5	14.048	14	14.452	OR 355.0x6.99-N70
458	0.275	14.476	0.375	0.06	15	14.548	14.5	14.952	OR 367.7x6.99-N70
459	0.275	14.975	0.375	0.06	15.5	15.048	15	15.452	OR 380.37x6.99-N70
460	0.275	15.476	0.375	0.06	16	15.548	15.5	15.952	OR 393.1x6.99-N70
461	0.275	15.955	0.375	0.06	16.5	16.048	16	16.452	OR 405.26x6.99-N70
462	0.275	16.455	0.375	0.06	17	16.548	16.5	16.952	OR 417.96x6.99-N70
463	0.275	16.955	0.375	0.06	17.5	17.048	17	17.452	OR 430.66x6.99-N70
464	0.275	17.455	0.375	0.06	18	17.548	17.5	17.952	OR 443.36x6.99-N70
465	0.275	17.955	0.375	0.06	18.5	18.048	18	18.452	OR 456.06x6.99-N70
466	0.275	18.455	0.375	0.06	19	18.548	18.5	18.952	OR 468.76x6.99-N70
467	0.275	18.955	0.375	0.06	19.5	19.048	19	19.452	OR 481.46x6.99-N70
468	0.275	19.455	0.375	0.06	20	19.548	19.5	19.952	OR 494.16x6.99-N70
469	0.275	19.955	0.375	0.06	20.5	20.048	20	20.452	OR 506.86x6.99-N70
470	0.275	20.955	0.375	0.06	21.5	21.048	21	21.452	OR 532.26x6.99-N70
471	0.275	21.955	0.375	0.06	22.5	22.048	22	22.452	OR 557.66x6.99-N70
472	0.275	22.94	0.375	0.06	23.5	23.048	23	23.452	OR 582.68x6.99-N70
473	0.275	23.94	0.375	0.06	24.5	24.048	24	24.452	OR 608.08x6.99-N70
474	0.275	24.94	0.375	0.06	25.5	25.048	25	25.452	OR 633.48x6.99-N70
475	0.275	25.94	0.375	0.06	26.5	26.048	26	26.452	OR 658.88x6.99-N70

Other sizes are available on request

## 6.3 STR Back-up rings in static radial sealing, metric sizes by dash-number

Dash-number **013 – 128**

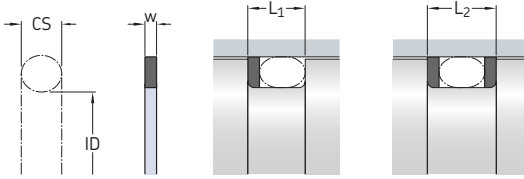

Back-up rings are selected by the corresponding O-ring dimensions.

Dash-number	Ring dimensions			Groove width		Designation
	ID	CS	w	L <sub>1</sub> +0,2	L <sub>2</sub> +0,2	
–	mm			mm		–
013	10,82	1,78	1,1	3,8	5,2	STR 19-013-395A
014	12,42	1,78	1,1	3,8	5,2	STR 19-014-395A
015	14	1,78	1,1	3,8	5,2	STR 19-015-395A
016	15,6	1,78	1,1	3,8	5,2	STR 19-016-395A
017	17,17	1,78	1,1	3,8	5,2	STR 19-017-395A
018	18,77	1,78	1,1	3,8	5,2	STR 19-018-395A
019	20,35	1,78	1,1	3,8	5,2	STR 19-019-395A
020	21,95	1,78	1,1	3,8	5,2	STR 19-020-395A
021	23,52	1,78	1,1	3,8	5,2	STR 19-021-395A
022	25,12	1,78	1,1	3,8	5,2	STR 19-022-395A
023	26,7	1,78	1,1	3,8	5,2	STR 19-023-395A
024	28,3	1,78	1,1	3,8	5,2	STR 19-024-395A
025	29,87	1,78	1,1	3,8	5,2	STR 19-025-395A
026	31,47	1,78	1,1	3,8	5,2	STR 19-026-395A
027	33,05	1,78	1,1	3,8	5,2	STR 19-027-395A
028	34,65	1,78	1,1	3,8	5,2	STR 19-028-395A
029	37,62	1,78	1,1	3,8	5,2	STR 19-029-395A
030	41	1,78	1,1	3,8	5,2	STR 19-030-395A
031	44,17	1,78	1,1	3,8	5,2	STR 19-031-395A
032	47,35	1,78	1,1	3,8	5,2	STR 19-032-395A
033	50,52	1,78	1,1	3,8	5,2	STR 19-033-395A

Dash-number	Ring dimensions			Groove width		Designation
	ID	CS	w	L <sub>1</sub> +0,2	L <sub>2</sub> +0,2	
–	mm			mm		–
034	53,7	1,78	1,1	3,8	5,2	STR 19-034-395A
035	56,87	1,78	1,1	3,8	5,2	STR 19-035-395A
036	60,05	1,78	1,1	3,8	5,2	STR 19-036-395A
037	63,22	1,78	1,1	3,8	5,2	STR 19-037-395A
038	66,4	1,78	1,1	3,8	5,2	STR 19-038-395A
039	69,57	1,78	1,1	3,8	5,2	STR 19-039-395A
040	72,75	1,78	1,1	3,8	5,2	STR 19-040-395A
041	75,92	1,78	1,1	3,8	5,2	STR 19-041-395A
042	82,27	1,78	1,1	3,8	5,2	STR 19-042-395A
043	88,62	1,78	1,1	3,8	5,2	STR 19-043-395A
044	94,97	1,78	1,1	3,8	5,2	STR 19-044-395A
045	101,32	1,78	1,1	3,8	5,2	STR 19-045-395A
046	107,67	1,78	1,1	3,8	5,2	STR 19-046-395A
047	114,02	1,78	1,1	3,8	5,2	STR 19-047-395A
048	120,37	1,78	1,1	3,8	5,2	STR 19-048-395A
049	126,72	1,78	1,1	3,8	5,2	STR 19-049-395A
050	133,07	1,78	1,1	3,8	5,2	STR 19-050-395A
111	10,77	2,62	1,3	5	6,4	STR 19-111-395A
112	12,37	2,62	1,3	5	6,4	STR 19-112-395A
113	13,94	2,62	1,3	5	6,4	STR 19-113-395A
114	15,54	2,62	1,3	5	6,4	STR 19-114-395A
115	17,12	2,62	1,3	5	6,4	STR 19-115-395A
116	18,72	2,62	1,3	5	6,4	STR 19-116-395A
117	20,29	2,62	1,3	5	6,4	STR 19-117-395A
118	21,89	2,62	1,3	5	6,4	STR 19-118-395A
119	23,47	2,62	1,3	5	6,4	STR 19-119-395A
120	25,07	2,62	1,3	5	6,4	STR 19-120-395A
121	26,64	2,62	1,3	5	6,4	STR 19-121-395A
122	28,24	2,62	1,3	5	6,4	STR 19-122-395A
123	29,82	2,62	1,3	5	6,4	STR 19-123-395A
124	31,42	2,62	1,3	5	6,4	STR 19-124-395A
125	32,99	2,62	1,3	5	6,4	STR 19-125-395A
126	34,59	2,62	1,3	5	6,4	STR 19-126-395A
127	36,17	2,62	1,3	5	6,4	STR 19-127-395A
128	37,77	2,62	1,3	5	6,4	STR 19-128-395A

## 6.3 STR Back-up rings in static radial sealing, metric sizes by dash-number

Dash-number 129 – 225

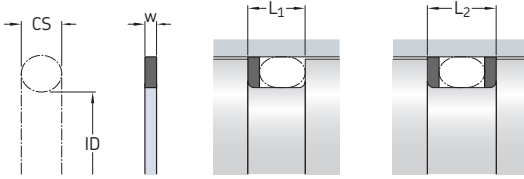

Back-up rings are selected by the corresponding O-ring dimensions.

Dash-number	Ring dimensions			Groove width		Designation
	ID	CS	w	L <sub>1</sub> +0,2	L <sub>2</sub> +0,2	
–	mm			mm		–
129	39,34	2,62	1,3	5	6,4	STR 19-129-395A
130	40,94	2,62	1,3	5	6,4	STR 19-130-395A
131	42,52	2,62	1,3	5	6,4	STR 19-131-395A
132	44,12	2,62	1,3	5	6,4	STR 19-132-395A
133	45,69	2,62	1,3	5	6,4	STR 19-133-395A
134	47,29	2,62	1,3	5	6,4	STR 19-134-395A
135	48,9	2,62	1,3	5	6,4	STR 19-135-395A
136	50,47	2,62	1,3	5	6,4	STR 19-136-395A
137	52,07	2,62	1,3	5	6,4	STR 19-137-395A
138	53,64	2,62	1,3	5	6,4	STR 19-138-395A
139	55,25	2,62	1,3	5	6,4	STR 19-139-395A
140	56,82	2,62	1,3	5	6,4	STR 19-140-395A
141	58,42	2,62	1,3	5	6,4	STR 19-141-395A
142	59,99	2,62	1,3	5	6,4	STR 19-142-395A
143	61,6	2,62	1,3	5	6,4	STR 19-143-395A
144	63,17	2,62	1,3	5	6,4	STR 19-144-395A
145	64,77	2,62	1,3	5	6,4	STR 19-145-395A
146	66,34	2,62	1,3	5	6,4	STR 19-146-395A
147	67,95	2,62	1,3	5	6,4	STR 19-147-395A
148	69,52	2,62	1,3	5	6,4	STR 19-148-395A
149	71,12	2,62	1,3	5	6,4	STR 19-149-395A



Dash-number	Ring dimensions			Groove width		Designation
	ID	CS	w	L <sub>1</sub> +0,2	L <sub>2</sub> +0,2	
–	mm			mm		–
150	72,69	2,62	1,3	5	6,4	STR 19-150-395A
151	75,87	2,62	1,3	5	6,4	STR 19-151-395A
152	82,22	2,62	1,3	5	6,4	STR 19-152-395A
153	88,57	2,62	1,3	5	6,4	STR 19-153-395A
154	94,92	2,62	1,3	5	6,4	STR 19-154-395A
155	101,27	2,62	1,3	5	6,4	STR 19-155-395A
158	120,32	2,62	1,3	5	6,4	STR 19-158-395A
159	126,67	2,62	1,3	5	6,4	STR 19-159-395A
160	133,02	2,62	1,3	5	6,4	STR 19-160-395A
161	139,37	2,62	1,3	5	6,4	STR 19-161-395A
162	145,72	2,62	1,3	5	6,4	STR 19-162-395A
163	152,07	2,62	1,3	5	6,4	STR 19-163-395A
167	177,47	2,62	1,3	5	6,4	STR 19-167-395A
205	10,69	3,53	1,5	6,2	7,6	STR 19-205-395A
206	12,29	3,53	1,5	6,2	7,6	STR 19-206-395A
207	13,87	3,53	1,5	6,2	7,6	STR 19-207-395A
208	15,47	3,53	1,5	6,2	7,6	STR 19-208-395A
209	17,04	3,53	1,5	6,2	7,6	STR 19-209-395A
210	18,64	3,53	1,5	6,2	7,6	STR 19-210-395A
211	20,22	3,53	1,5	6,2	7,6	STR 19-211-395A
212	21,82	3,53	1,5	6,2	7,6	STR 19-212-395A
213	23,39	3,53	1,5	6,2	7,6	STR 19-213-395A
214	24,99	3,53	1,5	6,2	7,6	STR 19-214-395A
215	26,57	3,53	1,5	6,2	7,6	STR 19-215-395A
216	28,17	3,53	1,5	6,2	7,6	STR 19-216-395A
217	29,74	3,53	1,5	6,2	7,6	STR 19-217-395A
218	31,34	3,53	1,5	6,2	7,6	STR 19-218-395A
219	32,92	3,53	1,5	6,2	7,6	STR 19-219-395A
220	34,52	3,53	1,5	6,2	7,6	STR 19-220-395A
221	36,09	3,53	1,5	6,2	7,6	STR 19-221-395A
222	37,69	3,53	1,5	6,2	7,6	STR 19-222-395A
223	40,87	3,53	1,5	6,2	7,6	STR 19-223-395A
224	44,04	3,53	1,5	6,2	7,6	STR 19-224-395A
225	47,22	3,53	1,5	6,2	7,6	STR 19-225-395A

## 6.3 STR Back-up rings in static radial sealing, metric sizes by dash-number

Dash-number 226 – 324

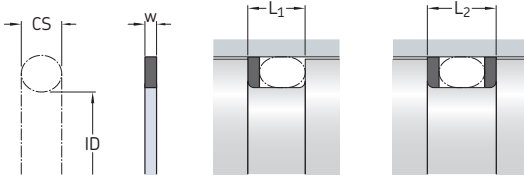

Back-up rings are selected by the corresponding O-ring dimensions.

Dash-number	Ring dimensions			Groove width		Designation
	ID	CS	w	L <sub>1</sub> +0,2	L <sub>2</sub> +0,2	
–	mm			mm		–
226	50,39	3,53	1,5	6,2	7,6	STR 19-226-395A
227	53,57	3,53	1,5	6,2	7,6	STR 19-227-395A
228	56,74	3,53	1,5	6,2	7,6	STR 19-228-395A
229	59,92	3,53	1,5	6,2	7,6	STR 19-229-395A
230	63,09	3,53	1,5	6,2	7,6	STR 19-230-395A
231	66,27	3,53	1,5	6,2	7,6	STR 19-231-395A
232	69,44	3,53	1,5	6,2	7,6	STR 19-232-395A
233	72,62	3,53	1,5	6,2	7,6	STR 19-233-395A
234	75,79	3,53	1,5	6,2	7,6	STR 19-234-395A
235	78,97	3,53	1,5	6,2	7,6	STR 19-235-395A
236	82,14	3,53	1,5	6,2	7,6	STR 19-236-395A
237	85,32	3,53	1,5	6,2	7,6	STR 19-237-395A
238	88,49	3,53	1,5	6,2	7,6	STR 19-238-395A
239	91,67	3,53	1,5	6,2	7,6	STR 19-239-395A
240	94,84	3,53	1,5	6,2	7,6	STR 19-240-395A
242	101,19	3,53	1,5	6,2	7,6	STR 19-242-395A
243	104,37	3,53	1,5	6,2	7,6	STR 19-243-395A
244	107,54	3,53	1,5	6,2	7,6	STR 19-244-395A
245	110,72	3,53	1,5	6,2	7,6	STR 19-245-395A
246	113,89	3,53	1,5	6,2	7,6	STR 19-246-395A
247	117,07	3,53	1,5	6,2	7,6	STR 19-247-395A

Dash-number	Ring dimensions			Groove width		Designation
	ID	CS	w	L <sub>1</sub> +0,2	L <sub>2</sub> +0,2	
–	mm			mm		–
248	120,24	3,53	1,5	6,2	7,6	STR 19-248-395A
249	123,42	3,53	1,5	6,2	7,6	STR 19-249-395A
250	126,59	3,53	1,5	6,2	7,6	STR 19-250-395A
251	129,77	3,53	1,5	6,2	7,6	STR 19-251-395A
252	132,94	3,53	1,5	6,2	7,6	STR 19-252-395A
253	136,12	3,53	1,5	6,2	7,6	STR 19-253-395A
254	139,29	3,53	1,5	6,2	7,6	STR 19-254-395A
255	142,47	3,53	1,5	6,2	7,6	STR 19-255-395A
256	145,64	3,53	1,5	6,2	7,6	STR 19-256-395A
257	148,82	3,53	1,5	6,2	7,6	STR 19-257-395A
258	151,99	3,53	1,5	6,2	7,6	STR 19-258-395A
259	158,34	3,53	1,5	6,2	7,6	STR 19-259-395A
260	164,69	3,53	1,5	6,2	7,6	STR 19-260-395A
261	171,04	3,53	1,5	6,2	7,6	STR 19-261-395A
262	177,39	3,53	1,5	6,2	7,6	STR 19-262-395A
265	196,44	3,53	1,5	6,2	7,6	STR 19-265-395A
266	202,79	3,53	1,5	6,2	7,6	STR 19-266-395A
267	209,14	3,53	1,5	6,2	7,6	STR 19-267-395A
268	215,49	3,53	1,5	6,2	7,6	STR 19-268-395A
269	221,84	3,53	1,5	6,2	7,6	STR 19-269-395A
270	228,19	3,53	1,5	6,2	7,6	STR 19-270-395A
271	234,54	3,53	1,5	6,2	7,6	STR 19-271-395A
272	240,89	3,53	1,5	6,2	7,6	STR 19-272-395A
273	247,24	3,53	1,5	6,2	7,6	STR 19-273-395A
314	18,42	5,33	1,7	8,8	10,5	STR 19-314-395A
316	21,59	5,33	1,7	8,8	10,5	STR 19-316-395A
317	23,16	5,33	1,7	8,8	10,5	STR 19-317-395A
318	24,77	5,33	1,7	8,8	10,5	STR 19-318-395A
319	26,34	5,33	1,7	8,8	10,5	STR 19-319-395A
320	27,94	5,33	1,7	8,8	10,5	STR 19-320-395A
321	29,51	5,33	1,7	8,8	10,5	STR 19-321-395A
322	31,12	5,33	1,7	8,8	10,5	STR 19-322-395A
323	32,69	5,33	1,7	8,8	10,5	STR 19-323-395A
324	34,29	5,33	1,7	8,8	10,5	STR 19-324-395A

6.3

## 6.3 STR Back-up rings in static radial sealing, metric sizes by dash-number

Dash-number 325 – 429

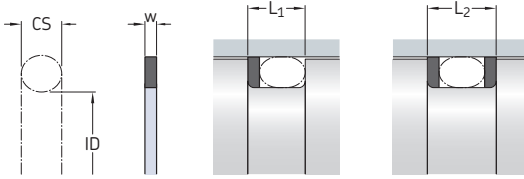

Back-up rings are selected by the corresponding O-ring dimensions.

Dash-number	Ring dimensions			Groove width		Designation
	ID	CS	w	L <sub>1</sub> +0,2	L <sub>2</sub> +0,2	
–	mm			mm		–
325	37,47	5,33	1,7	8,8	10,5	STR 19-325-395A
326	40,64	5,33	1,7	8,8	10,5	STR 19-326-395A
327	43,82	5,33	1,7	8,8	10,5	STR 19-327-395A
328	46,99	5,33	1,7	8,8	10,5	STR 19-328-395A
329	50,17	5,33	1,7	8,8	10,5	STR 19-329-395A
330	53,34	5,33	1,7	8,8	10,5	STR 19-330-395A
331	56,52	5,33	1,7	8,8	10,5	STR 19-331-395A
332	59,69	5,33	1,7	8,8	10,5	STR 19-332-395A
333	62,87	5,33	1,7	8,8	10,5	STR 19-333-395A
334	66,04	5,33	1,7	8,8	10,5	STR 19-334-395A
335	69,22	5,33	1,7	8,8	10,5	STR 19-335-395A
336	72,39	5,33	1,7	8,8	10,5	STR 19-336-395A
337	75,57	5,33	1,7	8,8	10,5	STR 19-337-395A
338	78,74	5,33	1,7	8,8	10,5	STR 19-338-395A
339	81,92	5,33	1,7	8,8	10,5	STR 19-339-395A
340	85,09	5,33	1,7	8,8	10,5	STR 19-340-395A
341	88,27	5,33	1,7	8,8	10,5	STR 19-341-395A
342	91,44	5,33	1,7	8,8	10,5	STR 19-342-395A
343	94,62	5,33	1,7	8,8	10,5	STR 19-343-395A
344	97,79	5,33	1,7	8,8	10,5	STR 19-344-395A
345	100,97	5,33	1,7	8,8	10,5	STR 19-345-395A

Dash-number	Ring dimensions			Groove width		Designation
	ID	CS	w	L <sub>1</sub> +0,2	L <sub>2</sub> +0,2	
–	mm			mm		–
346	104,14	5,33	1,7	8,8	10,5	STR 19-346-395A
347	107,32	5,33	1,7	8,8	10,5	STR 19-347-395A
348	110,49	5,33	1,7	8,8	10,5	STR 19-348-395A
349	113,67	5,33	1,7	8,8	10,5	STR 19-349-395A
350	116,84	5,33	1,7	8,8	10,5	STR 19-350-395A
351	120,02	5,33	1,7	8,8	10,5	STR 19-351-395A
352	123,19	5,33	1,7	8,8	10,5	STR 19-352-395A
353	126,37	5,33	1,7	8,8	10,5	STR 19-353-395A
354	129,54	5,33	1,7	8,8	10,5	STR 19-354-395A
355	132,72	5,33	1,7	8,8	10,5	STR 19-355-395A
356	135,89	5,33	1,7	8,8	10,5	STR 19-356-395A
357	139,07	5,33	1,7	8,8	10,5	STR 19-357-395A
358	142,24	5,33	1,7	8,8	10,5	STR 19-358-395A
359	145,42	5,33	1,7	8,8	10,5	STR 19-359-395A
360	148,59	5,33	1,7	8,8	10,5	STR 19-360-395A
361	151,77	5,33	1,7	8,8	10,5	STR 19-361-395A
362	158,12	5,33	1,7	8,8	10,5	STR 19-362-395A
363	164,47	5,33	1,7	8,8	10,5	STR 19-363-395A
364	170,82	5,33	1,7	8,8	10,5	STR 19-364-395A
365	177,17	5,33	1,7	8,8	10,5	STR 19-365-395A
366	183,52	5,33	1,7	8,8	10,5	STR 19-366-395A
367	189,87	5,33	1,7	8,8	10,5	STR 19-367-395A
368	196,22	5,33	1,7	8,8	10,5	STR 19-368-395A
369	202,57	5,33	1,7	8,8	10,5	STR 19-369-395A
370	208,92	5,33	1,7	8,8	10,5	STR 19-370-395A
371	215,27	5,33	1,7	8,8	10,5	STR 19-371-395A
372	221,62	5,33	1,7	8,8	10,5	STR 19-372-395A
373	227,97	5,33	1,7	8,8	10,5	STR 19-373-395A
374	234,32	5,33	1,7	8,8	10,5	STR 19-374-395A
375	240,67	5,33	1,7	8,8	10,5	STR 19-375-395A
425	113,67	6,99	2	12	14,5	STR 19-425-395A
426	116,84	6,99	2	12	14,5	STR 19-426-395A
427	120,02	6,99	2	12	14,5	STR 19-427-395A
428	123,19	6,99	2	12	14,5	STR 19-428-395A
429	126,37	6,99	2	12	14,5	STR 19-429-395A

## 6.3 STR Back-up rings in static radial sealing, metric sizes by dash-number

Dash-number 430 – 449

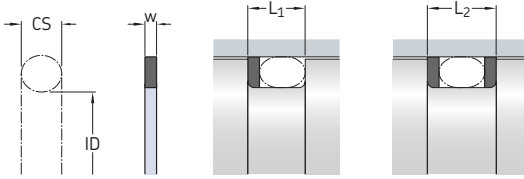

Back-up rings are selected by the corresponding O-ring dimensions.

Dash-number	Ring dimensions			Groove width		Designation
	ID	CS	w	L <sub>1</sub> +0,2	L <sub>2</sub> +0,2	
–	mm			mm		–
430	129,54	6,99	2	12	14,5	STR 19-430-395A
431	132,72	6,99	2	12	14,5	STR 19-431-395A
432	135,89	6,99	2	12	14,5	STR 19-432-395A
433	139,07	6,99	2	12	14,5	STR 19-433-395A
434	142,24	6,99	2	12	14,5	STR 19-434-395A
435	145,42	6,99	2	12	14,5	STR 19-435-395A
436	148,59	6,99	2	12	14,5	STR 19-436-395A
437	151,77	6,99	2	12	14,5	STR 19-437-395A
438	158,12	6,99	2	12	14,5	STR 19-438-395A
439	164,47	6,99	2	12	14,5	STR 19-439-395A
440	170,82	6,99	2	12	14,5	STR 19-440-395A
441	177,17	6,99	2	12	14,5	STR 19-441-395A
442	183,52	6,99	2	12	14,5	STR 19-442-395A
443	189,87	6,99	2	12	14,5	STR 19-443-395A
444	196,22	6,99	2	12	14,5	STR 19-444-395A
445	202,57	6,99	2	12	14,5	STR 19-445-395A
446	215,27	6,99	2	12	14,5	STR 19-446-395A
447	227,97	6,99	2	12	14,5	STR 19-447-395A
448	240,67	6,99	2	12	14,5	STR 19-448-395A
449	253,37	6,99	2	12	14,5	STR 19-449-395A

Other sizes are available on request



## 6.4 STR Back-up rings in static radial sealing, metric sizes

ID 9,3 – 99,5 mm

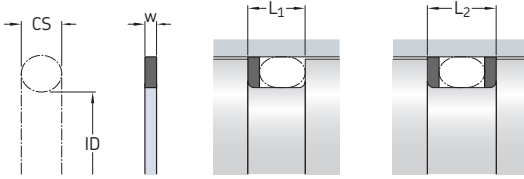

Back-up rings are selected by the corresponding O-ring dimensions.

Ring dimensions			Groove width		Designation
ID	CS	w	L <sub>1</sub> +0,2	L <sub>2</sub> +0,2	
mm			mm		-
9,3	2,4	1,3	4,6	6	STR 10x14x1.3-Y95A
10,3	2,4	1,3	4,6	6	STR 11x15x1.3-Y95A
11,3	2,4	1,3	4,6	6	STR 12x16x1.3-Y95A
12,3	2,4	1,3	4,6	6	STR 13x17x1.3-Y95A
13,3	2,4	1,3	4,6	6	STR 14x18x1.3-Y95A
14,3	2,4	1,3	4,6	6	STR 15x19x1.3-Y95A
15,3	2,4	1,3	4,6	6	STR 16x20x1.3-Y95A
17,3	2,4	1,3	4,6	6	STR 18x22x1.3-Y95A
18,3	2,4	1,3	4,6	6	STR 17x21x1.3-Y95A
19,2	3	1,3	5,4	6,8	STR 20x25x1.3-Y95A
21,2	3	1,3	5,4	6,8	STR 22x27x1.3-Y95A
22,2	3	1,3	5,4	6,8	STR 23x28x1.3-Y95A
24,2	3	1,3	5,4	6,8	STR 25x30x1.3-Y95A
26,2	3	1,3	5,4	6,8	STR 27x32x1.3-Y95A
29,2	3	1,3	5,4	6,8	STR 30x35x1.3-Y95A
31,2	3	1,3	5,4	6,8	STR 32x37x1.3-Y95A
32,2	3	1,3	5,4	6,8	STR 33x38x1.3-Y95A
34,2	3	1,3	5,4	6,8	STR 35x40x1.3-Y95A
35	3	1,3	5,4	6,8	STR 36x41x1.3-Y95A
36,2	3	1,3	5,4	6,8	STR 37x42x1.3-Y95A
39,2	3	1,3	5,4	6,8	STR 40x45x1.3-Y95A
	5,7	1,7	9,3	11,1	STR 40x50x1.7-Y95A



Ring dimensions			Groove width		Designation
ID	CS	w	L <sub>1</sub> +0,2	L <sub>2</sub> +0,2	
mm			mm		-
42,2	3	1,3	5,4	6,8	STR 43x48x1.3-Y95A
44,2	3	1,3	5,4	6,8	STR 45x50x1.3-Y95A
	5,7	1,7	9,3	11,1	STR 45x55x1.7-Y95A
49,2	5,7	1,7	9,3	11,1	STR 50x60x1.7-Y95A
49,5	3	1,3	5,4	6,8	STR 50x55x1.3-Y95A
52,3	5,7	1,7	9,3	11,1	STR 53x63x1.7-Y95A
54,2	5,7	1,7	9,3	11,1	STR 55x65x1.7-Y95A
54,5	3	1,3	5,4	6,8	STR 55x60x1.3-Y95A
56	3	1,3	5,4	6,8	STR 57x62x1.3-Y95A
57,5	3	1,3	5,4	6,8	STR 58x63x1.3-Y95A
59,2	5,7	1,7	9,3	11,1	STR 60x70x1.7-Y95A
59,5	3	1,3	5,4	6,8	STR 60x65x1.3-Y95A
62	3	1,3	5,4	6,8	STR 63x68x1.3-Y95A
64,2	5,7	1,7	9,3	11,1	STR 65x75x1.7-Y95A
64,5	3	1,3	5,4	6,8	STR 65x70x1.3-Y95A
67	3	1,3	5,4	6,8	STR 68x73x1.3-Y95A
68	3	1,3	5,4	6,8	STR 69x74x1.3-Y95A
69,2	5,7	1,7	9,3	11,1	STR 70x80x1.7-Y95A
69,5	3	1,3	5,4	6,8	STR 70x75x1.3-Y95A
74,2	5,7	1,7	9,3	11,1	STR 75x85x1.7-Y95A
74,5	3	1,3	5,4	6,8	STR 75x80x1.3-Y95A
75	3	1,3	5,4	6,8	STR 76x81x1.3-Y95A
78	3	1,3	5,4	6,8	STR 79x84x1.3-Y95A
79,2	5,7	1,7	9,3	11,1	STR 80x90x1.7-Y95A
79,5	3	1,3	5,4	6,8	STR 80x85x1.3-Y95A
84,1	5,7	1,7	9,3	11,1	STR 85x95x1.7-Y95A
84,5	3	1,3	5,4	6,8	STR 85x90x1.3-Y95A
87	3	1,3	5,4	6,8	STR 88x93x1.3-Y95A
89,1	5,7	1,7	9,3	11,1	STR 90x100x1.7-Y95A
89,5	3	1,3	5,4	6,8	STR 90x95x1.3-Y95A
94,1	5,7	1,7	9,3	11,1	STR 95x105x1.7-Y95A
94,5	3	1,3	5,4	6,8	STR 95x100x1.3-Y95A
98	3	1,3	5,4	6,8	STR 98x103x1.3-Y95A
99,1	5,7	1,7	9,3	11,1	STR 100x110x1.7-Y95A
99,5	3	1,3	5,4	6,8	STR 100x105x1.3-Y95A

## 6.4 STR Back-up rings in static radial sealing, metric sizes

ID 104,1 – 269,3 mm

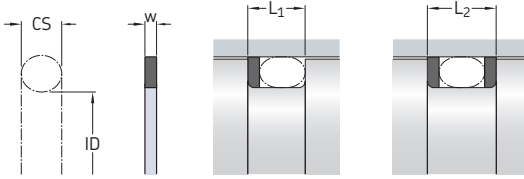

Back-up rings are selected by the corresponding O-ring dimensions.

Ring dimensions			Groove width		Designation
ID	CS	w	L <sub>1</sub> +0,2	L <sub>2</sub> +0,2	
mm			mm		-
104,1	5,7	1,7	9,3	11,1	STR 105x115x1.7-Y95A
104,5	3	1,3	5,4	6,8	STR 105x110x1.3-Y95A
109,1	5,7	1,7	9,3	11,1	STR 110x120x1.7-Y95A
109,5	3	1,3	5,4	6,8	STR 110x115x1.3-Y95A
114,3	5,7	1,7	9,3	11,1	STR 115x125x1.7-Y95A
114,5	3	1,3	5,4	6,8	STR 115x120x1.3-Y95A
119,3	5,7	1,7	9,3	11,1	STR 120x130x1.7-Y95A
119,5	3	1,3	5,4	6,8	STR 120x125x1.3-Y95A
124,3	5,7	1,7	9,3	11,1	STR 125x135x1.7-Y95A
124,5	3	1,3	5,4	6,8	STR 125x130x1.3-Y95A
129,3	5,7	1,7	9,3	11,1	STR 130x140x1.7-Y95A
129,5	3	1,3	5,4	6,8	STR 130x135x1.3-Y95A
134,3	5,7	1,7	9,3	11,1	STR 135x145x1.7-Y95A
134,5	3	1,3	5,4	6,8	STR 135x140x1.3-Y95A
139,3	5,7	1,7	9,3	11,1	STR 140x150x1.7-Y95A
139,5	3	1,3	5,4	6,8	STR 140x145x1.3-Y95A
144,3	5,7	1,7	9,3	11,1	STR 145x155x1.7-Y95A
144,5	3	1,3	5,4	6,8	STR 145x150x1.3-Y95A
149,3	5,7	1,7	9,3	11,1	STR 150x160x1.7-Y95A
154,3	5,7	1,7	9,3	11,1	STR 155x165x1.7-Y95A
154,5	3	1,3	5,4	6,8	STR 155x160x1.3-Y95A

Ring dimensions			Groove width		Designation
ID	CS	w	L <sub>1</sub> +0,2	L <sub>2</sub> +0,2	
mm			mm		-
159,3	5,7	1,7	9,3	11,1	STR 160x170x1.7-Y95A
164,3	5,7	1,7	9,3	11,1	STR 165x175x1.7-Y95A
169,3	5,7	1,7	9,3	11,1	STR 170x180x1.7-Y95A
174	3	1,3	5,4	6,8	STR 175x180x1.3-Y95A
174,3	5,7	1,7	9,3	11,1	STR 175x185x1.7-Y95A
179,3	5,7	1,7	9,3	11,1	STR 180x190x1.7-Y95A
184,3	5,7	1,7	9,3	11,1	STR 185x195x1.7-Y95A
189,3	5,7	1,7	9,3	11,1	STR 190x200x1.7-Y95A
194,3	5,7	1,7	9,3	11,1	STR 195x205x1.7-Y95A
199,3	5,7	1,7	9,3	11,1	STR 200x210x1.7-Y95A
209,3	5,7	1,7	9,3	11,1	STR 210x220x1.7-Y95A
219,3	5,7	1,7	9,3	11,1	STR 220x230x1.7-Y95A
229,3	5,7	1,7	9,3	11,1	STR 230x240x1.7-Y95A
239,3	5,7	1,7	9,3	11,1	STR 240x250x1.7-Y95A
244,3	5,7	1,7	9,3	11,1	STR 245x255x1.7-Y95A
249,3	5,7	1,7	9,3	11,1	STR 250x260x1.7-Y95A
269,3	5,7	1,7	9,3	11,1	STR 270x280x1.7-Y95A

Other sizes are available on request

## 6.5 STR Back-up rings in static radial sealing, inch sizes

Dash-number **013 – 167**

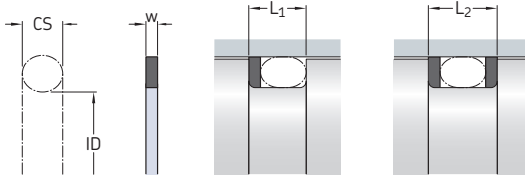

Back-up rings are selected by the corresponding O-ring dimensions.

Dash-number	Ring dimensions			Groove width		Designation
	CS	ID	w	L <sub>1</sub> +0.008	L <sub>2</sub> +0.008	
–	in.			in.		–
<b>013</b>	0.07	0.426	0.043	0.15	0.205	<b>STR 19-13-395A</b>
<b>014</b>	0.07	0.489	0.043	0.15	0.205	<b>STR 19-14-395A</b>
<b>015</b>	0.07	0.551	0.043	0.15	0.205	<b>STR 19-15-395A</b>
<b>016</b>	0.07	0.614	0.043	0.15	0.205	<b>STR 19-16-395A</b>
<b>017</b>	0.07	0.676	0.043	0.15	0.205	<b>STR 19-17-395A</b>
<b>018</b>	0.07	0.739	0.043	0.15	0.205	<b>STR 19-18-395A</b>
<b>019</b>	0.07	0.801	0.043	0.15	0.205	<b>STR 19-19-395A</b>
<b>020</b>	0.07	0.864	0.043	0.15	0.205	<b>STR 19-20-395A</b>
<b>021</b>	0.07	0.926	0.043	0.15	0.205	<b>STR 19-21-395A</b>
<b>022</b>	0.07	0.989	0.043	0.15	0.205	<b>STR 19-22-395A</b>
<b>023</b>	0.07	1.051	0.043	0.15	0.205	<b>STR 19-23-395A</b>
<b>024</b>	0.07	1.114	0.043	0.15	0.205	<b>STR 19-24-395A</b>
<b>025</b>	0.07	1.176	0.043	0.15	0.205	<b>STR 19-25-395A</b>
<b>026</b>	0.07	1.239	0.043	0.15	0.205	<b>STR 19-26-395A</b>
<b>027</b>	0.07	1.301	0.043	0.15	0.205	<b>STR 19-27-395A</b>
<b>028</b>	0.07	1.364	0.043	0.15	0.205	<b>STR 19-28-395A</b>
<b>029</b>	0.07	1.489	0.043	0.15	0.205	<b>STR 19-29-395A</b>
<b>030</b>	0.07	1.614	0.043	0.15	0.205	<b>STR 19-30-395A</b>
<b>031</b>	0.07	1.739	0.043	0.15	0.205	<b>STR 19-31-395A</b>
<b>032</b>	0.07	1.864	0.043	0.15	0.205	<b>STR 19-32-395A</b>
<b>033</b>	0.07	1.989	0.043	0.15	0.205	<b>STR 19-33-395A</b>
<b>034</b>	0.07	2.114	0.043	0.15	0.205	<b>STR 19-34-395A</b>
<b>035</b>	0.07	2.239	0.043	0.15	0.205	<b>STR 19-35-395A</b>
<b>036</b>	0.07	2.364	0.043	0.15	0.205	<b>STR 19-36-395A</b>
<b>037</b>	0.07	2.489	0.043	0.15	0.205	<b>STR 19-37-395A</b>
<b>038</b>	0.07	2.614	0.043	0.15	0.205	<b>STR 19-38-395A</b>
<b>039</b>	0.07	2.739	0.043	0.15	0.205	<b>STR 19-39-395A</b>
<b>040</b>	0.07	2.864	0.043	0.15	0.205	<b>STR 19-40-395A</b>
<b>041</b>	0.07	2.989	0.043	0.15	0.205	<b>STR 19-41-395A</b>
<b>042</b>	0.07	3.239	0.043	0.15	0.205	<b>STR 19-42-395A</b>
<b>043</b>	0.07	3.489	0.043	0.15	0.205	<b>STR 19-43-395A</b>
<b>044</b>	0.07	3.739	0.043	0.15	0.205	<b>STR 19-44-395A</b>
<b>045</b>	0.07	3.989	0.043	0.15	0.205	<b>STR 19-45-395A</b>
<b>046</b>	0.07	4.239	0.043	0.15	0.205	<b>STR 19-46-395A</b>

Dash-number	Ring dimensions			Groove width		Designation
	CS	ID	w	L <sub>1</sub> +0.008	L <sub>2</sub> +0.008	
-	in.			in.		-
047	0.07	4.489	0.043	0.15	0.205	STR 19-47-395A
048	0.07	4.739	0.043	0.15	0.205	STR 19-48-395A
049	0.07	4.989	0.043	0.15	0.205	STR 19-49-395A
050	0.07	5.239	0.043	0.15	0.205	STR 19-50-395A
111	0.103	0.424	0.051	0.197	0.252	STR 19-111-395A
112	0.103	0.487	0.051	0.197	0.252	STR 19-112-395A
113	0.103	0.549	0.051	0.197	0.252	STR 19-113-395A
114	0.103	0.612	0.051	0.197	0.252	STR 19-114-395A
115	0.103	0.674	0.051	0.197	0.252	STR 19-115-395A
116	0.103	0.737	0.051	0.197	0.252	STR 19-116-395A
117	0.103	0.799	0.051	0.197	0.252	STR 19-117-395A
118	0.103	0.862	0.051	0.197	0.252	STR 19-118-395A
119	0.103	0.924	0.051	0.197	0.252	STR 19-119-395A
120	0.103	0.987	0.051	0.197	0.252	STR 19-120-395A
121	0.103	1.049	0.051	0.197	0.252	STR 19-121-395A
122	0.103	1.112	0.051	0.197	0.252	STR 19-122-395A
123	0.103	1.174	0.051	0.197	0.252	STR 19-123-395A
124	0.103	1.237	0.051	0.197	0.252	STR 19-124-395A
125	0.103	1.299	0.051	0.197	0.252	STR 19-125-395A
126	0.103	1.362	0.051	0.197	0.252	STR 19-126-395A
127	0.103	1.424	0.051	0.197	0.252	STR 19-127-395A
128	0.103	1.487	0.051	0.197	0.252	STR 19-128-395A
129	0.103	1.549	0.051	0.197	0.252	STR 19-129-395A
130	0.103	1.612	0.051	0.197	0.252	STR 19-130-395A
131	0.103	1.674	0.051	0.197	0.252	STR 19-131-395A
132	0.103	1.737	0.051	0.197	0.252	STR 19-132-395A
133	0.103	1.799	0.051	0.197	0.252	STR 19-133-395A
134	0.103	1.862	0.051	0.197	0.252	STR 19-134-395A
135	0.103	1.925	0.051	0.197	0.252	STR 19-135-395A
136	0.103	1.987	0.051	0.197	0.252	STR 19-136-395A
137	0.103	2.05	0.051	0.197	0.252	STR 19-137-395A
138	0.103	2.112	0.051	0.197	0.252	STR 19-138-395A
139	0.103	2.175	0.051	0.197	0.252	STR 19-139-395A
140	0.103	2.237	0.051	0.197	0.252	STR 19-140-395A
141	0.103	2.3	0.051	0.197	0.252	STR 19-141-395A
142	0.103	2.362	0.051	0.197	0.252	STR 19-142-395A
143	0.103	2.425	0.051	0.197	0.252	STR 19-143-395A
144	0.103	2.487	0.051	0.197	0.252	STR 19-144-395A
145	0.103	2.55	0.051	0.197	0.252	STR 19-145-395A
146	0.103	2.612	0.051	0.197	0.252	STR 19-146-395A
147	0.103	2.675	0.051	0.197	0.252	STR 19-147-395A
148	0.103	2.737	0.051	0.197	0.252	STR 19-148-395A
149	0.103	2.8	0.051	0.197	0.252	STR 19-149-395A
150	0.103	2.862	0.051	0.197	0.252	STR 19-150-395A
151	0.103	2.987	0.051	0.197	0.252	STR 19-151-395A
152	0.103	3.237	0.051	0.197	0.252	STR 19-152-395A
153	0.103	3.487	0.051	0.197	0.252	STR 19-153-395A
154	0.103	3.737	0.051	0.197	0.252	STR 19-154-395A
155	0.103	3.987	0.051	0.197	0.252	STR 19-155-395A
158	0.103	4.737	0.051	0.197	0.252	STR 19-158-395A
159	0.103	4.987	0.051	0.197	0.252	STR 19-159-395A
160	0.103	5.237	0.051	0.197	0.252	STR 19-160-395A
161	0.103	5.487	0.051	0.197	0.252	STR 19-161-395A
162	0.103	5.737	0.051	0.197	0.252	STR 19-162-395A
163	0.103	5.987	0.051	0.197	0.252	STR 19-163-395A
167	0.103	6.987	0.051	0.197	0.252	STR 19-167-395A

## 6.5 STR Back-up rings in static radial sealing, inch sizes

Dash-number 205 – 339

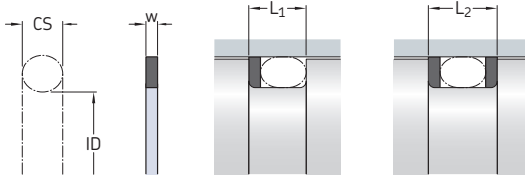

Back-up rings are selected by the corresponding O-ring dimensions.

Dash-number	Ring dimensions			Groove width		Designation
	CS	ID	w	L <sub>1</sub> +0.008	L <sub>2</sub> +0.008	
–	in.			in.		–
205	0.139	0.421	0.051	0.244	0.299	STR 19-205-395A
206	0.139	0.484	0.051	0.244	0.299	STR 19-206-395A
207	0.139	0.546	0.051	0.244	0.299	STR 19-207-395A
208	0.139	0.609	0.051	0.244	0.299	STR 19-208-395A
209	0.139	0.671	0.051	0.244	0.299	STR 19-209-395A
210	0.139	0.734	0.051	0.244	0.299	STR 19-210-395A
211	0.139	0.796	0.051	0.244	0.299	STR 19-211-395A
212	0.139	0.859	0.051	0.244	0.299	STR 19-212-395A
213	0.139	0.921	0.051	0.244	0.299	STR 19-213-395A
214	0.139	0.984	0.051	0.244	0.299	STR 19-214-395A
215	0.139	1.046	0.051	0.244	0.299	STR 19-215-395A
216	0.139	1.109	0.051	0.244	0.299	STR 19-216-395A
217	0.139	1.171	0.051	0.244	0.299	STR 19-217-395A
218	0.139	1.234	0.051	0.244	0.299	STR 19-218-395A
219	0.139	1.296	0.051	0.244	0.299	STR 19-219-395A
220	0.139	1.359	0.051	0.244	0.299	STR 19-220-395A
221	0.139	1.421	0.051	0.244	0.299	STR 19-221-395A
222	0.139	1.484	0.051	0.244	0.299	STR 19-222-395A
223	0.139	1.609	0.051	0.244	0.299	STR 19-223-395A
224	0.139	1.734	0.051	0.244	0.299	STR 19-224-395A
225	0.139	1.859	0.051	0.244	0.299	STR 19-225-395A
226	0.139	1.984	0.051	0.244	0.299	STR 19-226-395A
227	0.139	2.109	0.051	0.244	0.299	STR 19-227-395A
228	0.139	2.234	0.051	0.244	0.299	STR 19-228-395A
229	0.139	2.359	0.051	0.244	0.299	STR 19-229-395A
230	0.139	2.484	0.051	0.244	0.299	STR 19-230-395A
231	0.139	2.609	0.051	0.244	0.299	STR 19-231-395A
232	0.139	2.734	0.051	0.244	0.299	STR 19-232-395A
233	0.139	2.859	0.051	0.244	0.299	STR 19-233-395A
234	0.139	2.984	0.051	0.244	0.299	STR 19-234-395A
235	0.139	3.109	0.051	0.244	0.299	STR 19-235-395A
236	0.139	3.234	0.051	0.244	0.299	STR 19-236-395A
237	0.139	3.359	0.051	0.244	0.299	STR 19-237-395A
238	0.139	3.484	0.051	0.244	0.299	STR 19-238-395A
239	0.139	3.609	0.051	0.244	0.299	STR 19-239-395A
240	0.139	3.734	0.051	0.244	0.299	STR 19-240-395A

Dash-number	Ring dimensions			Groove width		Designation
	CS	ID	w	L <sub>1</sub> +0.008	L <sub>2</sub> +0.008	
–	in.			in.		–
242	0.139	3.984	0.051	0.244	0.299	STR 19-242-395A
243	0.139	4.109	0.051	0.244	0.299	STR 19-243-395A
244	0.139	4.234	0.051	0.244	0.299	STR 19-244-395A
245	0.139	4.359	0.051	0.244	0.299	STR 19-245-395A
246	0.139	4.484	0.051	0.244	0.299	STR 19-246-395A
247	0.139	4.609	0.051	0.244	0.299	STR 19-247-395A
248	0.139	4.734	0.051	0.244	0.299	STR 19-248-395A
249	0.139	4.859	0.051	0.244	0.299	STR 19-249-395A
250	0.139	4.984	0.051	0.244	0.299	STR 19-250-395A
251	0.139	5.109	0.051	0.244	0.299	STR 19-251-395A
252	0.139	5.234	0.051	0.244	0.299	STR 19-252-395A
253	0.139	5.359	0.051	0.244	0.299	STR 19-253-395A
254	0.139	5.484	0.051	0.244	0.299	STR 19-254-395A
255	0.139	5.609	0.051	0.244	0.299	STR 19-255-395A
256	0.139	5.734	0.051	0.244	0.299	STR 19-256-395A
257	0.139	5.859	0.051	0.244	0.299	STR 19-257-395A
258	0.139	5.984	0.051	0.244	0.299	STR 19-258-395A
259	0.139	6.234	0.051	0.244	0.299	STR 19-259-395A
260	0.139	6.484	0.051	0.244	0.299	STR 19-260-395A
261	0.139	6.734	0.051	0.244	0.299	STR 19-261-395A
262	0.139	6.984	0.051	0.244	0.299	STR 19-262-395A
265	0.139	7.734	0.051	0.244	0.299	STR 19-265-395A
266	0.139	7.984	0.051	0.244	0.299	STR 19-266-395A
267	0.139	8.234	0.051	0.244	0.299	STR 19-267-395A
268	0.139	8.484	0.051	0.244	0.299	STR 19-268-395A
269	0.139	8.734	0.051	0.244	0.299	STR 19-269-395A
270	0.139	8.984	0.051	0.244	0.299	STR 19-270-395A
271	0.139	9.234	0.051	0.244	0.299	STR 19-271-395A
272	0.139	9.484	0.051	0.244	0.299	STR 19-272-395A
273	0.139	9.734	0.051	0.244	0.299	STR 19-273-395A
310	0.21	0.475	0.067	0.346	0.413	STR 19-310-395A
311	0.21	0.537	0.067	0.346	0.413	STR 19-311-395A
312	0.21	0.6	0.067	0.346	0.413	STR 19-312-395A
313	0.21	0.662	0.067	0.346	0.413	STR 19-313-395A
314	0.21	0.725	0.067	0.346	0.413	STR 19-314-395A
315	0.21	0.787	0.067	0.346	0.413	STR 19-315-395A
316	0.21	0.85	0.067	0.346	0.413	STR 19-316-395A
317	0.21	0.912	0.067	0.346	0.413	STR 19-317-395A
318	0.21	0.975	0.067	0.346	0.413	STR 19-318-395A
319	0.21	1.037	0.067	0.346	0.413	STR 19-319-395A
320	0.21	1.1	0.067	0.346	0.413	STR 19-320-395A
321	0.21	1.162	0.067	0.346	0.413	STR 19-321-395A
322	0.21	1.225	0.067	0.346	0.413	STR 19-322-395A
323	0.21	1.287	0.067	0.346	0.413	STR 19-323-395A
324	0.21	1.35	0.067	0.346	0.413	STR 19-324-395A
325	0.21	1.475	0.067	0.346	0.413	STR 19-325-395A
326	0.21	1.6	0.067	0.346	0.413	STR 19-326-395A
327	0.21	1.725	0.067	0.346	0.413	STR 19-327-395A
328	0.21	1.85	0.067	0.346	0.413	STR 19-328-395A
329	0.21	1.975	0.067	0.346	0.413	STR 19-329-395A
330	0.21	2.1	0.067	0.346	0.413	STR 19-330-395A
331	0.21	2.225	0.067	0.346	0.413	STR 19-331-395A
332	0.21	2.35	0.067	0.346	0.413	STR 19-332-395A
333	0.21	2.475	0.067	0.346	0.413	STR 19-333-395A
334	0.21	2.6	0.067	0.346	0.413	STR 19-334-395A
335	0.21	2.725	0.067	0.346	0.413	STR 19-335-395A
336	0.21	2.85	0.067	0.346	0.413	STR 19-336-395A
337	0.21	2.975	0.067	0.346	0.413	STR 19-337-395A
338	0.21	3.1	0.067	0.346	0.413	STR 19-338-395A
339	0.21	3.225	0.067	0.346	0.413	STR 19-339-395A

## 6.5 STR Back-up rings in static radial sealing, inch sizes

Dash-number 340 – 449

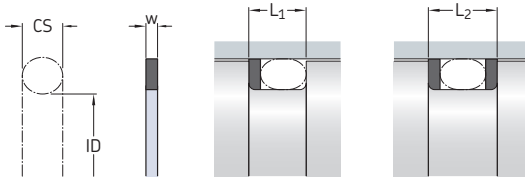

Back-up rings are selected by the corresponding O-ring dimensions.

Dash-number	Ring dimensions			Groove width		Designation
	CS	ID	w	L <sub>1</sub> +0.008	L <sub>2</sub> +0.008	
–	in.			in.		–
340	0.21	3.35	0.067	0.346	0.413	STR 19-340-395A
341	0.21	3.475	0.067	0.346	0.413	STR 19-341-395A
342	0.21	3.6	0.067	0.346	0.413	STR 19-342-395A
343	0.21	3.725	0.067	0.346	0.413	STR 19-343-395A
344	0.21	3.85	0.067	0.346	0.413	STR 19-344-395A
345	0.21	3.975	0.067	0.346	0.413	STR 19-345-395A
346	0.21	4.1	0.067	0.346	0.413	STR 19-346-395A
347	0.21	4.225	0.067	0.346	0.413	STR 19-347-395A
348	0.21	4.35	0.067	0.346	0.413	STR 19-348-395A
349	0.21	4.475	0.067	0.346	0.413	STR 19-349-395A
350	0.21	4.6	0.067	0.346	0.413	STR 19-350-395A
351	0.21	4.725	0.067	0.346	0.413	STR 19-351-395A
352	0.21	4.85	0.067	0.346	0.413	STR 19-352-395A
353	0.21	4.975	0.067	0.346	0.413	STR 19-353-395A
354	0.21	5.1	0.067	0.346	0.413	STR 19-354-395A
355	0.21	5.225	0.067	0.346	0.413	STR 19-355-395A
356	0.21	5.35	0.067	0.346	0.413	STR 19-356-395A
357	0.21	5.475	0.067	0.346	0.413	STR 19-357-395A
358	0.21	5.6	0.067	0.346	0.413	STR 19-358-395A
359	0.21	5.725	0.067	0.346	0.413	STR 19-359-395A
360	0.21	5.85	0.067	0.346	0.413	STR 19-360-395A
361	0.21	5.975	0.067	0.346	0.413	STR 19-361-395A
362	0.21	6.225	0.067	0.346	0.413	STR 19-362-395A
363	0.21	6.475	0.067	0.346	0.413	STR 19-363-395A
364	0.21	6.725	0.067	0.346	0.413	STR 19-364-395A
365	0.21	6.975	0.067	0.346	0.413	STR 19-365-395A
366	0.21	7.225	0.067	0.346	0.413	STR 19-366-395A
367	0.21	7.475	0.067	0.346	0.413	STR 19-367-395A
368	0.21	7.725	0.067	0.346	0.413	STR 19-368-395A
369	0.21	7.975	0.067	0.346	0.413	STR 19-369-395A
370	0.21	8.225	0.067	0.346	0.413	STR 19-370-395A
371	0.21	8.475	0.067	0.346	0.413	STR 19-371-395A
372	0.21	8.725	0.067	0.346	0.413	STR 19-372-395A
373	0.21	8.975	0.067	0.346	0.413	STR 19-373-395A
374	0.21	9.225	0.067	0.346	0.413	STR 19-374-395A
375	0.21	9.475	0.067	0.346	0.413	STR 19-375-395A



Dash-number	Ring dimensions			Groove width		Designation
	CS	ID	w	L <sub>1</sub> +0.008	L <sub>2</sub> +0.008	
–	in.			in.		–
425	0.275	4.475	0.079	0.472	0.571	STR 19-425-395A
426	0.275	4.6	0.079	0.472	0.571	STR 19-426-395A
427	0.275	4.725	0.079	0.472	0.571	STR 19-427-395A
428	0.275	4.85	0.079	0.472	0.571	STR 19-428-395A
429	0.275	4.975	0.079	0.472	0.571	STR 19-429-395A
430	0.275	5.1	0.079	0.472	0.571	STR 19-430-395A
431	0.275	5.225	0.079	0.472	0.571	STR 19-431-395A
432	0.275	5.35	0.079	0.472	0.571	STR 19-432-395A
433	0.275	5.475	0.079	0.472	0.571	STR 19-433-395A
434	0.275	5.6	0.079	0.472	0.571	STR 19-434-395A
435	0.275	5.725	0.079	0.472	0.571	STR 19-435-395A
436	0.275	5.85	0.079	0.472	0.571	STR 19-436-395A
437	0.275	5.975	0.079	0.472	0.571	STR 19-437-395A
438	0.275	6.225	0.079	0.472	0.571	STR 19-438-395A
439	0.275	6.475	0.079	0.472	0.571	STR 19-439-395A
440	0.275	6.725	0.079	0.472	0.571	STR 19-440-395A
441	0.275	6.975	0.079	0.472	0.571	STR 19-441-395A
442	0.275	7.225	0.079	0.472	0.571	STR 19-442-395A
443	0.275	7.475	0.079	0.472	0.571	STR 19-443-395A
444	0.275	7.725	0.079	0.472	0.571	STR 19-444-395A
445	0.275	7.975	0.079	0.472	0.571	STR 19-445-395A
446	0.275	8.475	0.079	0.472	0.571	STR 19-446-395A
447	0.275	8.975	0.079	0.472	0.571	STR 19-447-395A
448	0.275	9.475	0.079	0.472	0.571	STR 19-448-395A
449	0.275	9.975	0.079	0.472	0.571	STR 19-449-395A

Other sizes are available on request

## Other O-ring sealing and ring materials

### Dynamic radial sealing

Under certain conditions, O-rings can be used for dynamic sealing with relative motion between the coaxial parts. These sealing arrangements are limited to slow reciprocating or oscillating motions. The radial section  $S$  should be increased to  $S_1$  using

$$S_1 = \frac{CS + S}{2}$$

where

$S_1$  = increased radial section [mm]

$CS$  = cross section [mm] (→ **product tables**)

$S$  = radial section [mm] (→ **product tables**)

For additional dimensions, refer to the relevant standards (→ **table 3, page 294**).

For additional information, contact SKF.

### Static axial sealing

O-rings can also be used for static axial sealing between two opposing parts. However, static axial sealing arrangements are not common in hydraulic cylinder applications, however, examples are shown in **figure 3**.

For additional information, contact SKF.

Fig. 3

#### Static axial sealing examples

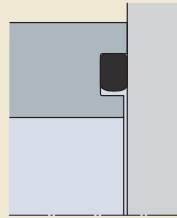

Rectangular groove, inside pressure

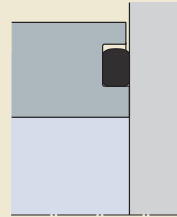

Rectangular groove, outside pressure

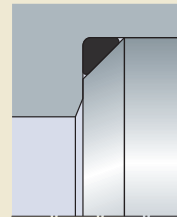

Triangle groove

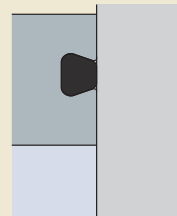

Trapezoidal groove

### PTFE encapsulated O-rings

SKF supplies O-rings, type ECOR, encapsulated with PTFE materials (FEP or PFA) and a core made of silicone or fluoroelastomer. The seamless and uniform PTFE encapsulation protects the core material against fluid and air.

ECOR O-rings are preferred for static sealing and not appropriate for continuously dynamic applications due to its thin and soft encapsulation. They are characterized by the following properties:

- chemical resistant
- wide temperature range
- anti-adhesive, low breakaway friction
- good resistance to wear
- good resistance to UV light
- can be sterilized in accordance with FDA (Food and Drug Administration) requirements
- low steam permeability
- low water absorption

For available sizes and additional information, contact SKF.

### Back-up rings made of polyester thermoplastic elastomer

SKF also supplies back-up rings made of polyester thermoplastic elastomer (TPC).

For additional information, contact SKF.

### Back-up rings made of PTFE

SKF back-up rings made of PTFE are suitable in applications with high temperatures or aggressive fluid. PTFE back-up rings are available unfilled or with an appropriate filler.

Back-up rings made of unfilled PTFE can be machined from tube blanks with outside diameters ranging from 1 to 1 500 mm (*0.039 to 59 in.*). Therefore, they can easily be adapted to customer specific installations and delivered on short notice.

For additional information, contact SKF.



# Other fluid power applications

Hydraulic rock breaker hammers . . . .	348
Hydraulic presses . . . . .	349
Hinge pin joints . . . . .	349
Rotary unions . . . . .	350
Hydraulic motors . . . . .	350
Pneumatic fluid power applications . .	351

## Other fluid power applications

*This catalogue contains the standard assortment of SKF hydraulic seals and guides typically used in hydraulic cylinders. Furthermore, SKF provides a wide range of standard and customized sealing solutions for a variety of other fluid power applications. In this chapter, you find some examples of these capabilities. For a solution that best meets the demands of your application, contact SKF.*

### Hydraulic rock breaker hammers

Hydraulic rock breaker hammers are a demanding application requiring hydraulic reciprocating seals working in short strokes and extreme high velocity.

SKF has many special solutions for rock hammers, including TEFLATHANE seals with a special high temperature TPU seal that is bonded to a low friction PTFE support base to extend service life for significant maintenance savings.

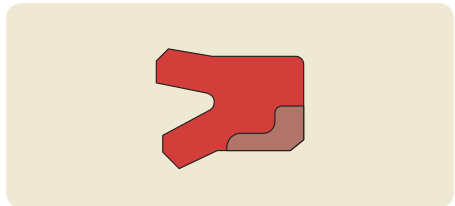

## Hydraulic presses

Each hydraulic press application is unique and should work reliably for many years without costly downtime or expensive repairs. SKF has decades of experience developing and manufacturing tailor-made press seal solutions for original equipment manufacturers, as well as retrofit assemblies for legacy equipment.

With moulded and machined seal capabilities and virtually unlimited diameter range, SKF can customize and manufacture sealing solutions to optimize system performance and increase performance and decrease operating costs.



## Hinge pin joints

Hinge pin seals retain pin joint bearing lubricants and exclude contaminants on off highway equipment that operates in harsh outdoor environments across all climates and weather conditions.

SKF PAK-L press-in seals are optimized for demanding pin joint applications. The wear resistant polyurethane seal materials reduce relubrication intervals and extend both seal and hinge joint bearing life. In addition, SKF has experience developing tailor-made pin joint seal solutions.





## Other fluid power applications

### Rotary unions

Rotary unions (also known as rotary manifolds or swivel joints) accommodate the flow of fluids between machine components with relative rotating or oscillating motion. They convey gases, lubricants, coolants and working fluids for fluid power.

SKF has sealing solutions and capabilities to accommodate virtually any rotary union application. The IM profile seal for hydraulic rotary manifolds is optimized for low friction and is available with a bonded energizer to improve energy efficiency and extend service life.



### Hydraulic motors

Hydraulic motors rotate with high torque from high-pressure hydraulic fluid flow. Certain motor designs and applications require the shaft seal to handle high pressure. The demands for higher power, efficient operation and long life require improvements over the typical rubber shaft seals.

SKF designs and develops tailor-made high-pressure rotary seals for hydraulic motors with PTFE sealing contacts for reduced friction and wear to increase energy saving and extend service life.





# Pneumatic fluid power applications

Special gas-sealing applications with high pressure, high speed, extreme high temperatures, cryogenic low temperatures or special gases place high demands on pneumatic seals.

SKF can provide a customized solution that meets your most demanding pneumatic sealing needs, designed specifically to enhance reliability and performance in your application.

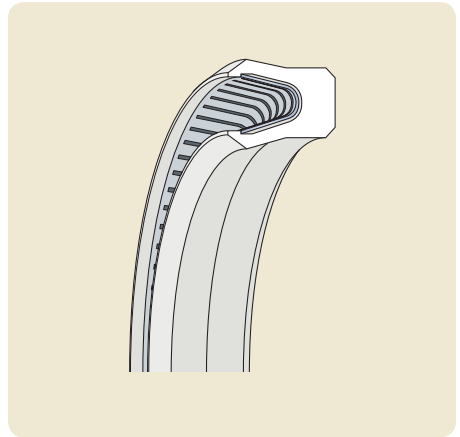
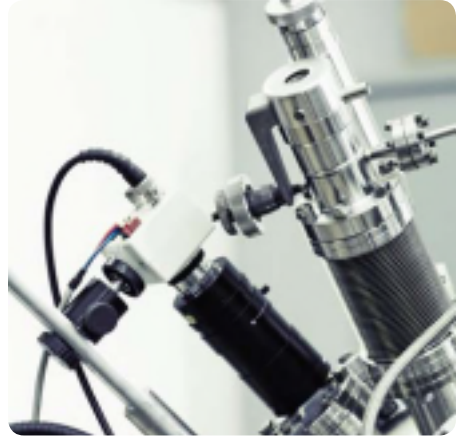

# Product index

Profile/ designation	Product	Section No.	Profile data Page	Product tables	
				Page <sup>1)</sup> Metric	Inch
APR	Piston seals	2.6	76	77	79
CPV	Piston seals	2.4	64	–	65
CUT	Piston seals	2.9	90	91	–
DPV	Piston seals	2.2	60	–	61
DTW	Wiper seals	4.4	228	229	232
DX	Wiper seals	4.5	236	–	237
DZ	Rod seals	3.6	178	179	180
DZR	Rod seals	3.7	184	185	186
GH	Piston seals	2.5	66	67	70
HW	Wiper seals	4.6	240	241	243
LCP	Piston seals	2.7	82	83	85
LPV	Piston seals	2.3	62	63	–
LTP	Piston seals	2.8	86	–	87
MCW	Wiper seals	4.2	220	221	223
MD-L	Piston seals	2.11	98	99	–
MPV	Piston seals	2.1	58	59	–
OR	O-rings (metric)	6.1	–	300	–
	O-rings (inch)	6.2	–	–	316
PA	Wiper seals	4.1	216	217	–
PAD	Wiper seals	4.3	226	227	–
PADV	Wiper seals	4.3	226	227	–
PGR	Piston guide rings	5.4	–	284	–
PTB	Rod seals	3.4	138	139	149
RBB	Buffer seals	3.8	188	189	191
RGR	Rod guide rings	5.3	–	280	–
RSB	Buffer seals	3.10	198	–	199
S1S	Rod seals	3.1	122	123	–
S9B	Buffer seals	3.9	192	193	196
SCP	Piston seals	2.10	94	–	95
SIL	Rod seals	3.3	134	135	–
STD	Rod seals	3.5	164	–	165
STR	Back-up rings (metric, by dash number)	6.3	–	324	–
	Back-up rings (metric)	6.4	–	334	–
	Back-up rings (inch)	6.5	–	–	338
UNP	Piston seals	2.12	102	103	105
WAT	Rod or piston guide rings (metric)	5.1	–	260	–
	Rod or piston guide rings (inch)	5.2	–	–	266
ZBR	Rod seals	3.2	126	127	131

<sup>1)</sup> Starting page of the product table



